



Badheizkörper

Erweitertes Sortiment für Modelle
mit Elektro-Heizeinsätzen

system**therm**

Farben	5
Heizkörper	11
Heizkörper Technische Informationen	145
Elektro-Heizkörper Pulverlack	323
Elektro-Heizkörper Galvanische Oberfläche	341
Zubehör Ablagen und Aufhänger	351
Heizpatronen	363
Heizpatronen Technische Informationen	395
Aufbau des Konfigurationscodes	435
Legende	441
Anschlusstabelle	444

Farben

Farben

Die gezeigten Farben können geringfügig von den tatsächlichen abweichen. Für eine genaue Farbauswahl sollten Originalmuster verwendet werden. Diese sind bei unseren Vertriebsmitarbeitern und Handelspartnern verfügbar.

RAL-Farbpalette

RAL: CODE:	1000 100	1001 101	1002 102	1003 103	1004 104	1005 105	1006 106	1007 107	1011 111	1012 112	1013 113	1014 114
1015 115	1016 116	1017 117	1018 118	1019 119	1020 120	1021 121	1023 123	1024 124	1027 127	1028 128	1032 132	1033 133
1034 134	1037 137	2000 200	2001 201	2002 202	2003 203	2004 204	2008 208	2009 209	2010 210	2011 211	2012 212	3000 300
3001 301	3002 302	3003 303	3004 304	3005 305	3007 307	3009 309	3011 311	3012 312	3013 313	3014 314	3015 315	3016 316
3017 317	3018 318	3020 320	3022 322	3027 327	3031 331	4001 401	4002 402	4003 403	4004 404	4005 405	4006 406	4007 407
4008 408	4009 409	4010 410	5000 500	5001 501	5002 502	5003 503	5004 504	5005 505	5007 507	5008 508	5009 509	5010 510
5011 511	5012 512	5013 513	5014 514	5015 515	5017 517	5018 518	5019 519	5020 520	5021 521	5022 522	5023 523	5024 524
6000 600	6001 601	6002 602	6003 603	6004 604	6005 605	6006 606	6007 607	6008 608	6009 609	6010 610	6011 611	6012 612
6013 613	6014 614	6015 615	6016 616	6017 617	6018 618	6019 619	6020 620	6021 621	6022 622	6024 624	6025 625	6026 626
6027 627	6028 628	6029 629	6032 632	6033 633	6034 634	7000 700	7001 701	7002 702	7003 703	7004 704	7005 705	7006 706
7008 708	7009 709	7010 710	7011 711	7012 712	7013 713	7015 715	7016 716	7021 721	7022 722	7023 723	7024 724	7026 726
7030 730	7031 731	7032 732	7033 733	7034 734	7035 735	7036 736	7037 737	7038 738	7039 739	7040 740	7042 742	7043 743
7044 744	7045 745	7046 746	7047 747	8000 800	8001 801	8002 802	8003 803	8004 804	8007 807	8008 808	8011 811	8012 812
8014 814	8015 815	8016 816	8017 817	8019 819	8022 822	8023 823	8024 824	8025 825	8028 828	9001 901	9002 902	9003 903
9004 904	9005 905	9005 mat 9M5	9005 gloss 9P5	9006 906	9007 907	9010 910	9011 911	9016 916	9017 917	9018 918		

Palette der Sonderfarben

	<p>Name: code:</p>	 <p>Heban IHE</p>	 <p>Black Pepper CPE</p>	 <p>Metallic Black MBC</p>
 <p>Black Crocodile BLC</p>	 <p>Soft 9005 S95</p>	 <p>Sparkling Grey RGY</p>	 <p>Metallic Grey MGR</p>	
 <p>Granite GRA</p>	 <p>Modern Grey DGR</p>	 <p>Storm Sky SSK</p>	 <p>Winter Sky WSK</p>	
 <p>Graphite GRP</p>	 <p>Salt & Pepper SPP</p>	 <p>Diamond Silver DIS</p>	 <p>Silver Gloss SPO</p>	
 <p>Silver Mat SMA</p>	 <p>Metallic Silver MSI</p>	 <p>Vibrant Brown OVB</p>	 <p>Metallic Stone MST</p>	
 <p>Sparkling Gravel RGR</p>	 <p>Metallic Beige MBE</p>	 <p>African Bronze IAZ</p>	 <p>Noble Brown INB</p>	
 <p>Antique Copper AMI</p>	 <p>Copper COP</p>	 <p>Van Gogh IVG</p>	 <p>Gold Gloss GPO</p>	
 <p>California Beige ICB</p>	 <p>Bahama Beige OBB</p>	 <p>Morning Beige BTS</p>	 <p>Sparkling Cream RCR</p>	

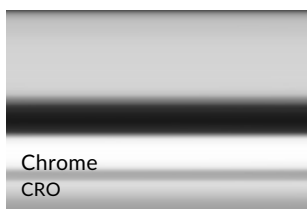

Galvanische Beschichtungen

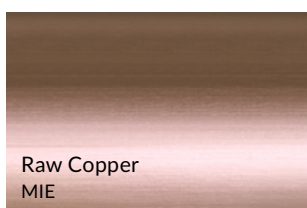

Kupferrohr

Diese Option ist nur für die Heizkörper Pajak und Pajak E erhältlich. Aufgrund seiner Eigenschaften kann Kupfer mit der Zeit dunkler werden und seine Farbe zu rötlich oder rötlich-braun ändern.

Heizkörper

Alex ⓘ Seite 146

Alex One ⓘ Seite 150

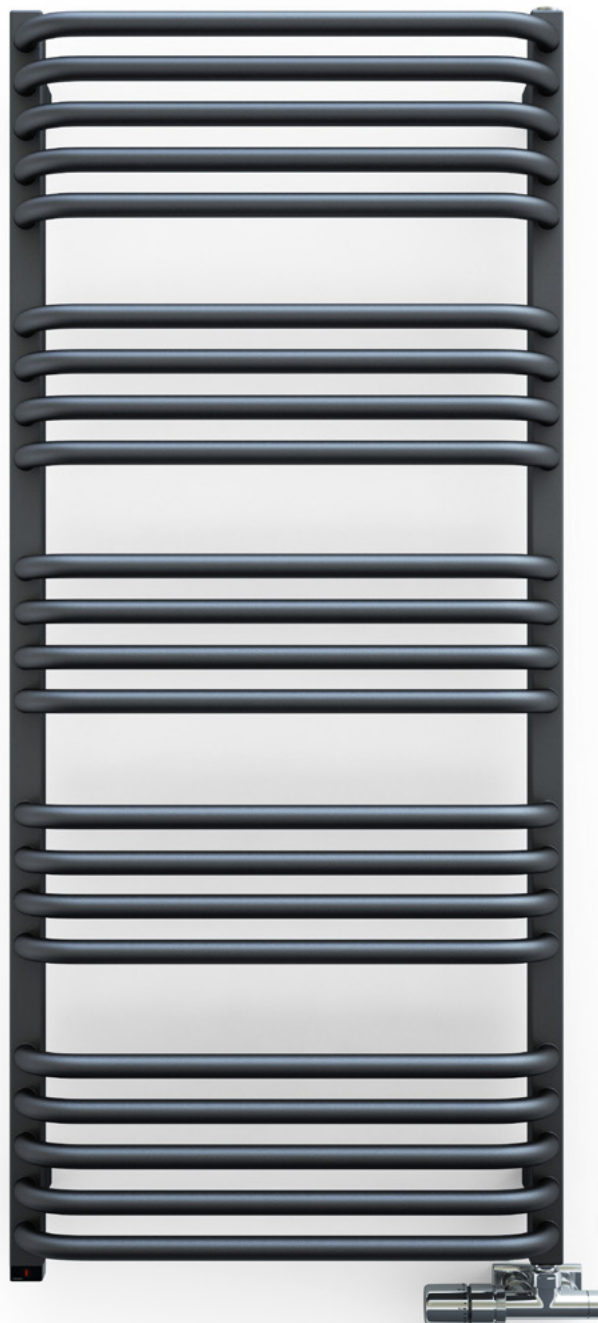

Alex One 1140↕ x 600↔ S1
Farbe: Modern Grey

Anschlussgarnitur: Set Lanzen-Thermostat-Verbunddeckventil, rechts, Chrom
Abdeckblende Chrom
Integrierte Heizpatrone ONE





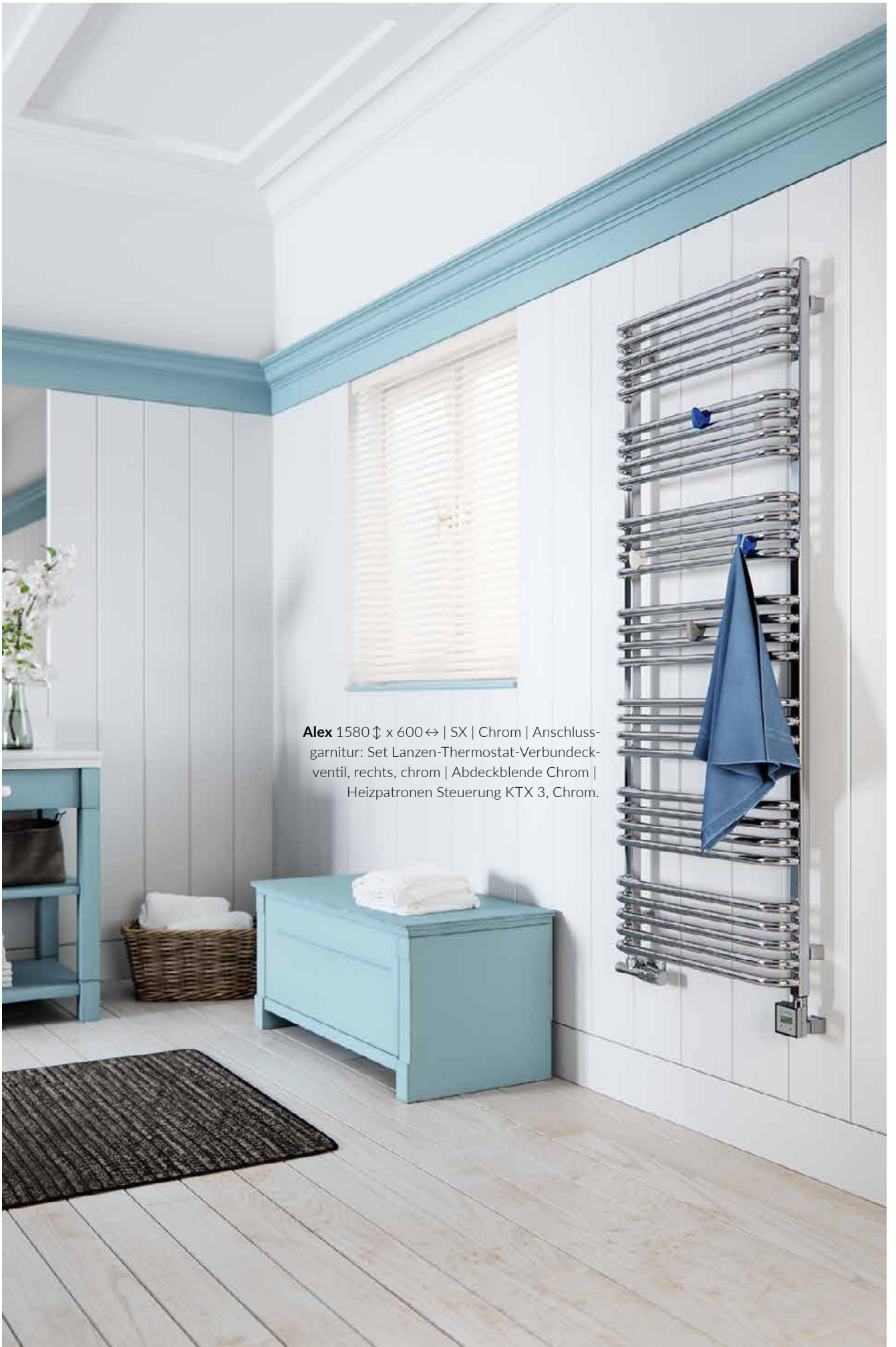

Alex 1580 ↑ x 600 ↔ | SX | Chrom | Anschluss-garnitur: Set Lanzen-Thermostat-Verbunddeck-ventil, rechts, chrom | Abdeckblende Chrom | Heizpatronen Steuerung KTX 3, Chrom.

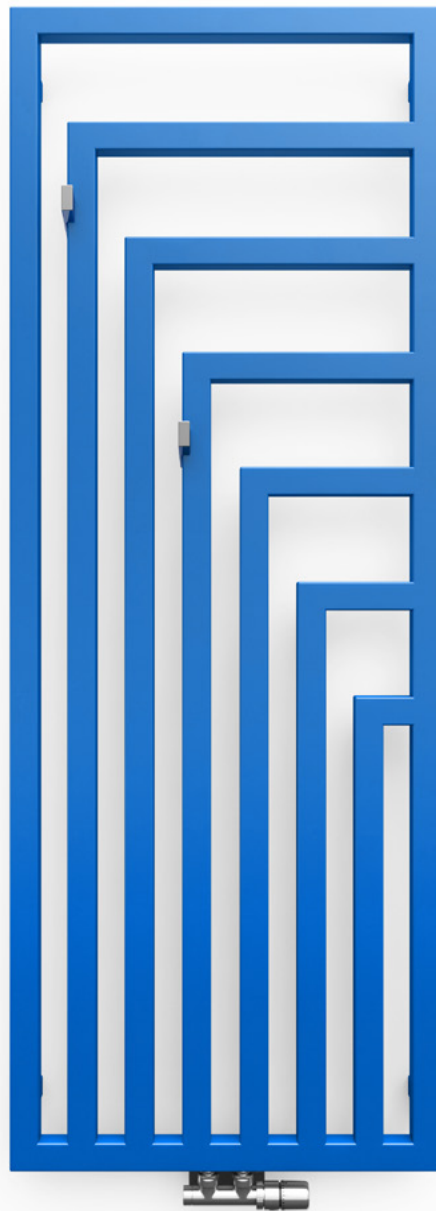

Angus V 1620↑ x 600↔ ZX
Farbe: RAL 5015

Anschlussgarnitur: Set Thermostat Verbunddeckventil, links, Chrom
Abdeckblende, Chrom
Handtuchhalter ZIP V 30





Angus V 1780↓ x 680↔ SX |
Vibrant Brown | Anschlussgarni-
tur: Set Lanzel-Thermostat-Ver-
bundeckventil, rechts, chrom |
Abdeckblende, Chrom | Heizpatro-
nen Steuerung KTX 4 Blue, chrom
| Handtuchhalter ZIP V 30





Angus H 520⇕ x 1460↔ Y7
Farbe: Soft Green Apple

Anschlussgarnitur: Set Thermostat Verbunddeckventil, links, Chrom
Abdeckblende, Chrom
Heizpatronen Steuerung KTX 2, Chrom

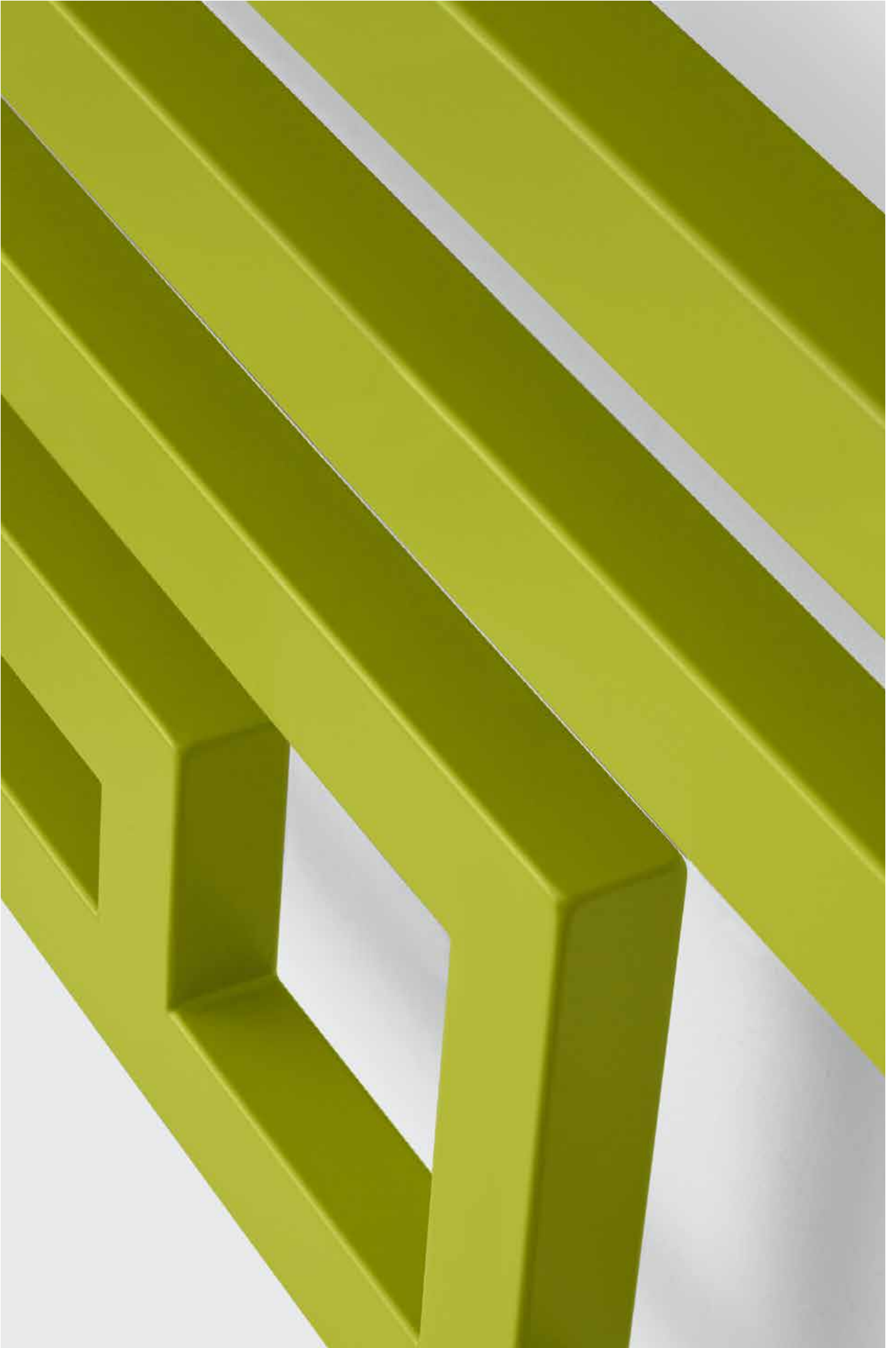

Bone

① Seite 160

Bone One

① Seite 162



Bone 1260↑ x 500↔ SX

Farbe: Noble Brown

Anschlussgarnitur: Set Lanzen-Thermostat-Verbunddeckventil, rechts, Chrom

Abdeckblende, Chrom

Heizpatrone REG 3 Weiß mit grauem Ring



Bone DW

① Seite 164

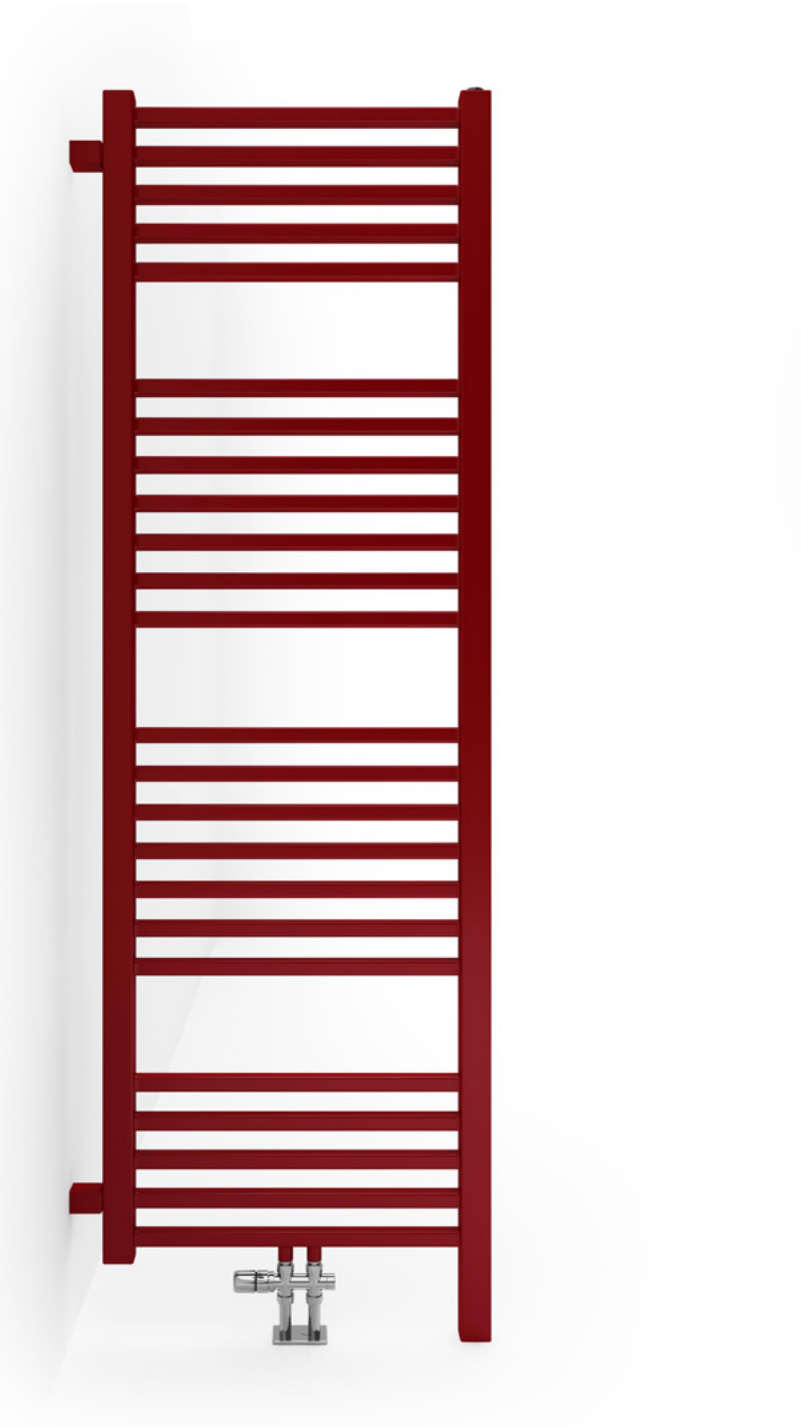

Bone DW 1610↑ x 500↔ ZX

Farbe: RAL 3003

Anschlussgarnitur: Set Lanzen-Thermostat-Verbunddeckventil, rechts, Chrom
Abdeckblende, Chrom



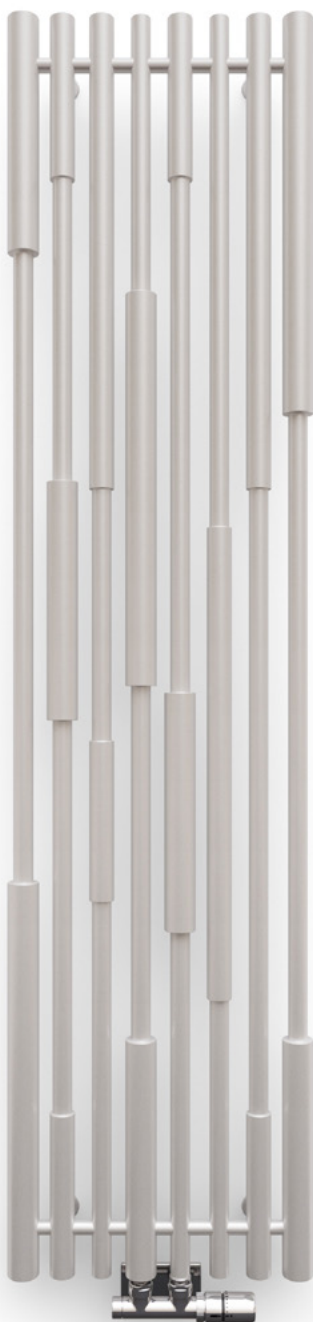

Cane 1600↕ x 390↔ ZX

Farbe: White Gold

Anschlussgarnitur: Set Thermostat Verbunddeckventil, links, Chrom
Abdeckblende, Chrom



Case Slim

① Seite 168

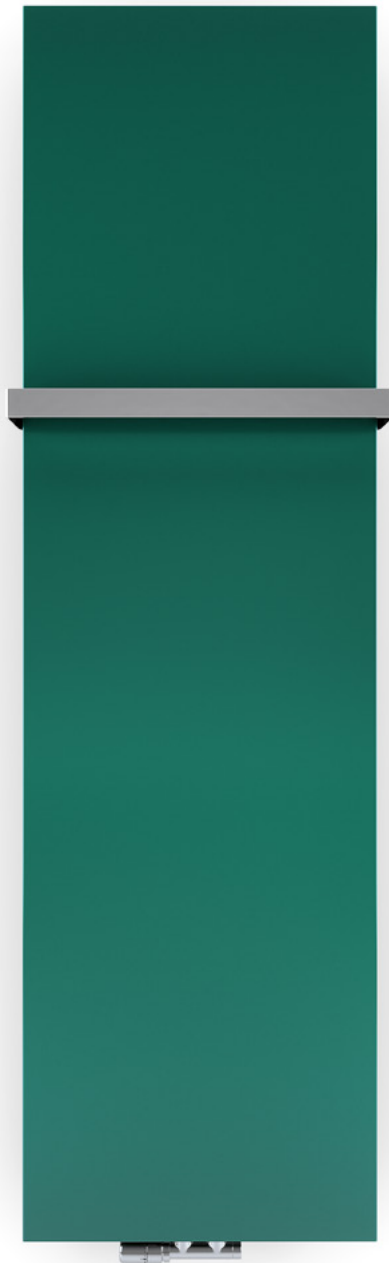

Case Slim 1810↓ x 520↔ ZX
Farbe: RAL 6004

Anschlussgarnitur: Set Thermostat Verbunddeckventil, rechts, Chrom
Abdeckblende, Chrom
Handtuchhalter Case Slim, Chrom



Case Slim 1585 ↓ x 520 ↔ ZX |
Grafik | Anschlussgarnitur: Set Ther-
mostat Verbunddeckventil, rechts, Chrom
| Abdeckblende, Chrom | Handtuchhalter
Case Slim, Chrom







GLAS



SPIEGEL



BETON

Die Metalloberfläche ist in 249 Farben verfügbar (RAL- und Sonderfarben sowie Beton). Die Betonbeschichtung wird von Hand aufgetragen und besitzt eine einzigartige Oberflächenstruktur. Die Glasbeschichtung (Fläche) ist in RAL-Farben erhältlich (außer Metalllackierungen und fluoreszierende Farben – Einzelheiten auf der Seite des Herstellers) mit einer Grafik des Herstellers oder einem eigenen Projekt.

Alle Heizkörper mit Glasoberfläche (RAL, mit Grafik vom Hersteller oder eigenem Projekt) sowie mit Spiegel können mit speziellen Stiften (optional erhältlich) auch als Tafeln benutzt werden. Wenn Sie eigene Stifte verwenden möchten, achten Sie bitte darauf, dass diese abwaschbar und für Glas geeignet sind.

Vorgeschlagene Grafiken* :



01



02

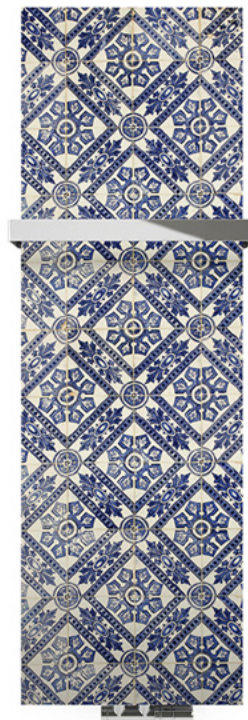

03



04



05



06



07



08

* Die Grafiken sind verfügbar für die Oberflächen aus Glas. Aktuell verfügbare Grafiken finden Sie auf der Seite des Herstellers. Falls Sie eine eigene Grafik verwenden möchten, wenden Sie sich bitte an unseren Handelspartner.

City

① Seite 172

City One

① Seite 174

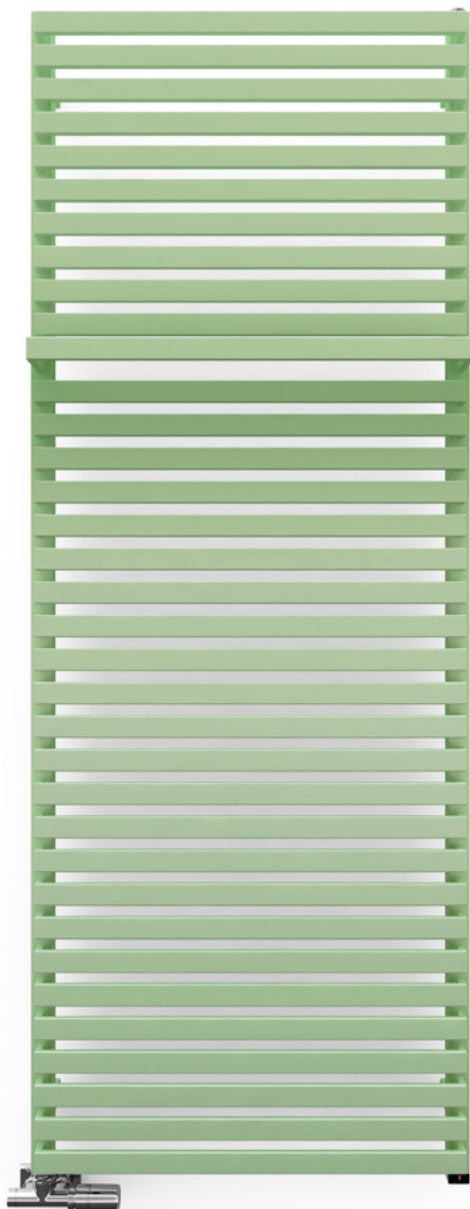

City One 1590↑ x 600↔ S8
Farbe: RAL 6019

Anschlussgarnitur: Set Lanzen-Thermostat-Verbunddeckventil, links, Chrom
Abdeckblende Chrom
Integrierte Heizpatrone ONE



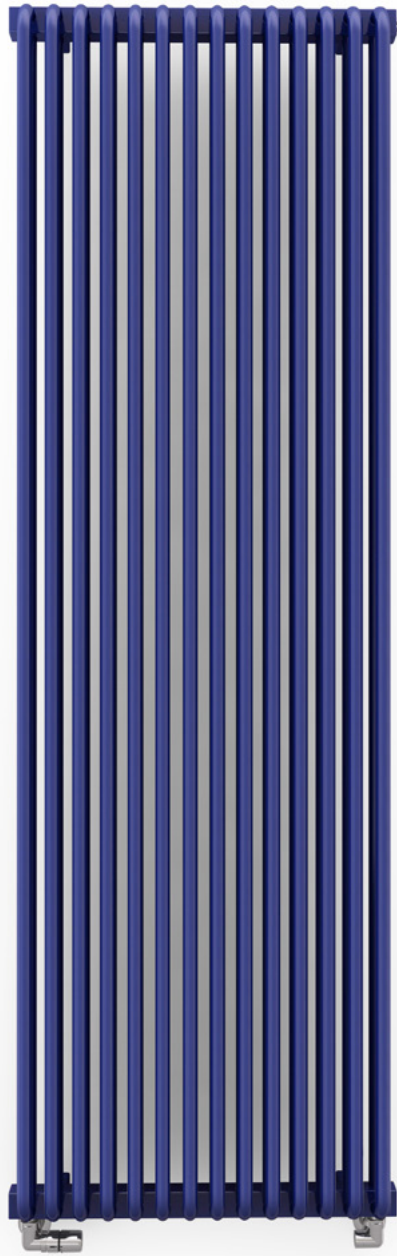

Delfin 1800↑ x 580↔ SX
Farbe: RAL 5022

Anschlussgarnitur: Set Winkeleck-Thermostatventil, links, Chrom
Set einteilige Blende Chrom





Delfin 540 ↑ x 1220 ↔ VP | Metallic Black | Anschlussgarnitur:
Set Absperr-Verbunddeckventil, Chrom | Abdeckblende, Chrom



Dexter

① Seite 184

Dexter One ① Seite 186



Dexter 1220↑ x 600↔ SX

Farbe: Modern Grey

Anschlussgarnitur: Set Thermostatventil DEXTER, links, Chrom

Set einteilige Blende, Chrom



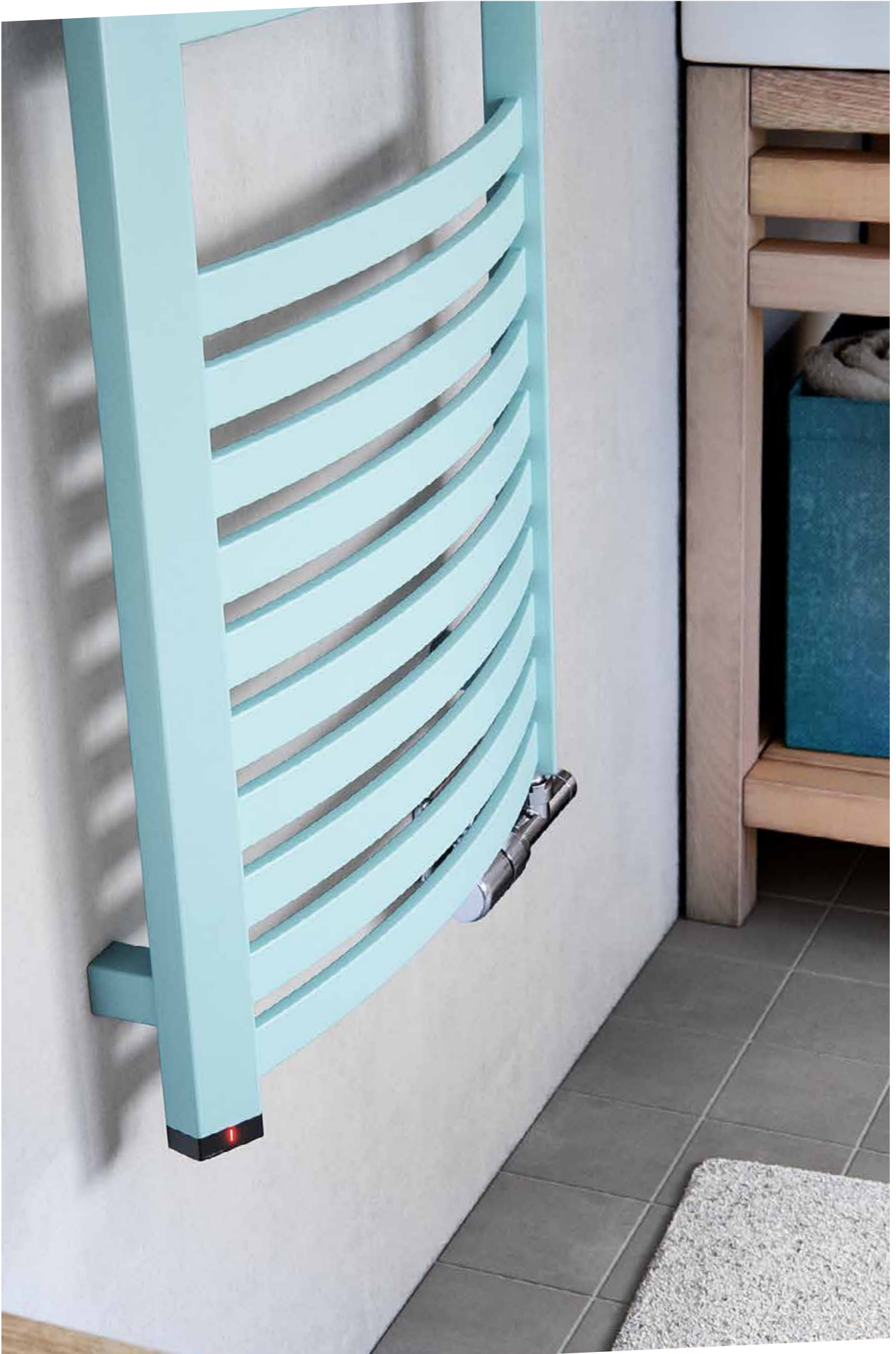



Dexter One 1760 ↑ x 500 ↔ S1 |
Pastel Blue | Anschlussgarnitur: Set
Lanzen-Thermostat-Verbunddeckven-
til, rechts, Chrom | Abdeckblende,
Chrom | Integrierte Heizpatrone
ONE mit Trapezprofil

Diamond

Seite 188

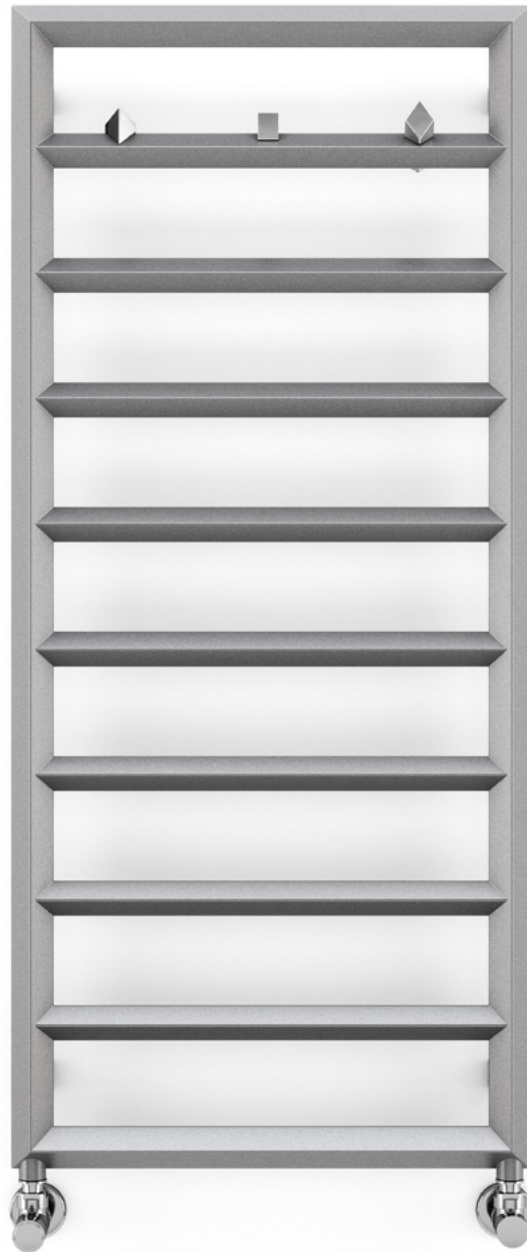

Diamond 1120↓ x 500↔ SX
Farbe: Diamond Silver

Anschlussgarnitur: Set Regel-Eckventil, Chrom
Set einteilige Blende, Chrom
3 x Handtuchhalter Spark, Chrom





Diamond 1120 ↑ x 500 ↔
SX | RAL 5021 | Anschluss-
garnitur: Set Lanzen-Ther-
mostat-Verbunddeckventil,
rechts, Chrom | Abdeck-
blende, Chrom | Heizpatro-
ne DRY Chrom





Domi 1116↑ x 500↔ SX
Farbe: Chrom

Anschlussgarnitur: Set Lanzen-Thermostat-Verbunddeckventil, rechts, Chrom
Abdeckblende, Chrom
Elektroheizpatrone REG 3 Silber mit chromfarbigem Ring



Easy

① Seite 194

Easy One

① Seite 196



Easy 1600↑ x 200↔ E8

Farbe: Heban

Heizpatronen Steuerung KTX 4, schwarz



Easy One 1280 ↓ x 200 ↔ 58 |
RAL 3003 | Anschlussgarnitur: Set
Lanzen-Thermostat-Verbunddeck-
ventil, links, Chrom | Abdeckblen-
de, Chrom | Ablage Easy, Buche
| Integrierte Heizpatrone ONE
Profil 30x40





Easy DW

① Seite 198

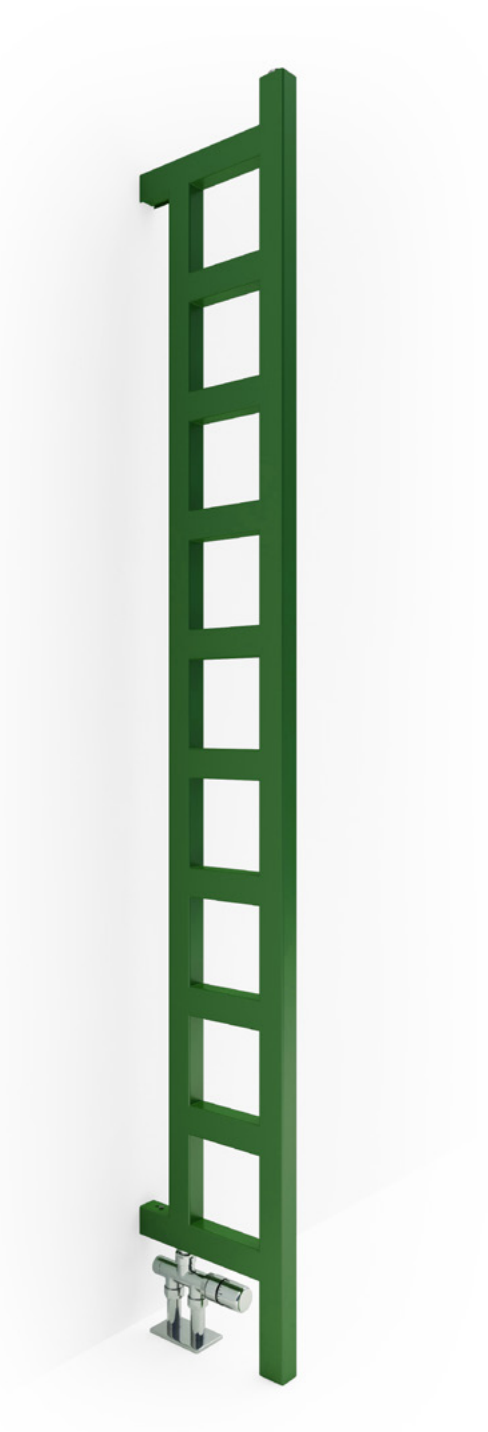

Easy DW 1660↑ x 200↔ O1
Farbe: RAL 6010

Anschlussgarnitur: Set Lanzen-Thermostat-Verbunddurchgangsventil, links, Chrom
Abdeckblende, Chrom





Easy DW 1980↑ x 200⇔ O1 |
RAL 5002 | Anschlussgarnitur:
Set Lanzen-Thermostat-Ver-
bunddurchgangsventil, links,
Chrom | Abdeckblende, Chrom



Fiona

① Seite 200

Fiona One ① Seite 206

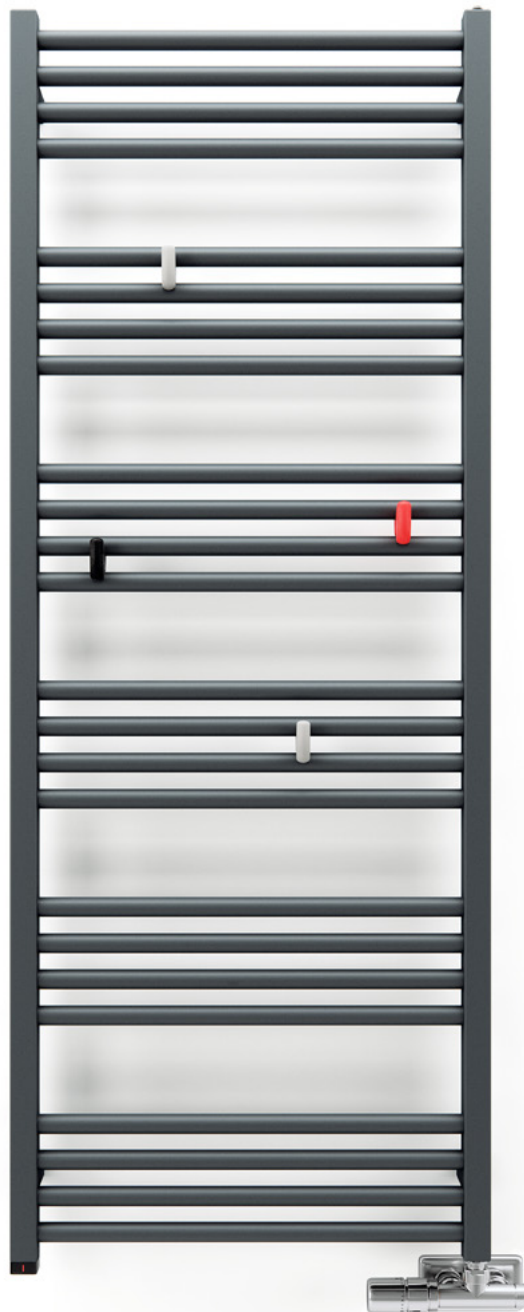

Fiona One 1380↑ x 530⇔ S1

Farbe: Modern Grey

Anschlussgarnitur: Set Lanzen-Thermostat-Verbunddeckventil, rechts, Chrom
Abdeckblende, Chrom

Integrierte Heizpatrone ONE 30x30 Profil

Handtuchhalter Yo! 2 x Weiß, 1 x Schwarz, 1 x Rot





Fiona 1860↕ x 530↔ SX |
RAL 5014 | Anschlussgarni-
tur: Set Lanzen-Thermostat-
Verbunddeckventil, rechts,
Chrom | Abdeckblende,
Chrom | Heizpatrone DRY
Chrom | Handtuchhalter Yo!
2 x Weiß, 2 x Grau





Incorner 1275 ↑ x 350 ↔ E1
Farbe: RAL 3005

Heizpatrone KTX 2, Schwarz

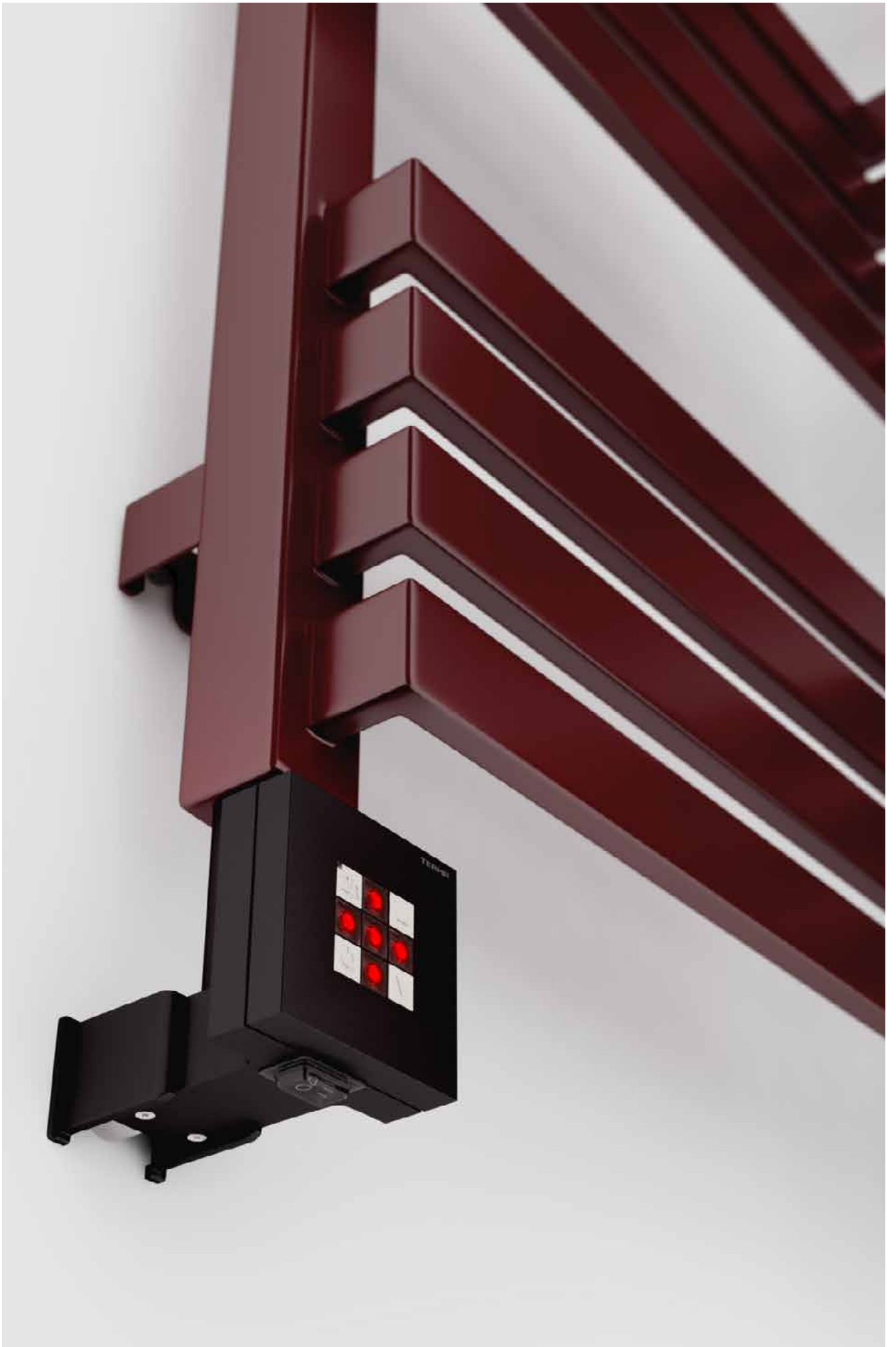





Incorner 1000 ↓ x 350 ↔ SX |
Sparkling Grey | Anschlussgarnitur:
Set Winkeleck-Thermostatventil, links,
Chrom | Set einteilige Blende, Chrom

Iron D

Seite 214

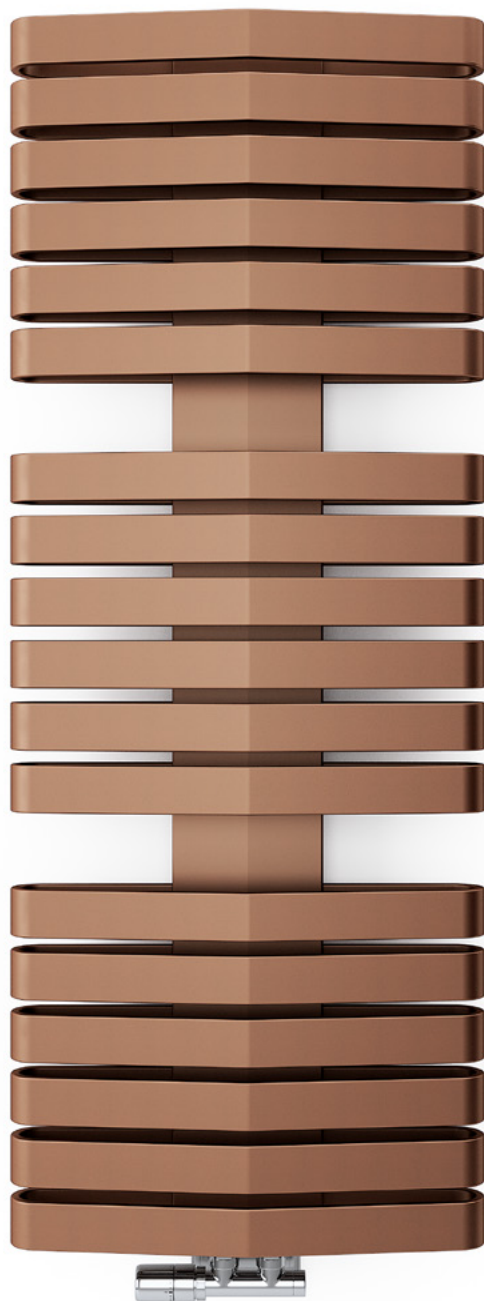

Iron D 1315↑ x 500↔ ZX

Farbe: Copper

Anschlussgarnitur: Set Thermostat Verbunddeckventil, rechts, Chrom
Abdeckblende, Chrom





Iron D 1510↑ x 500↔ ZX | Metallic Red | Set Thermostat Verbunddeckventil mit Anschlussmöglichkeit für eine Heizpatrone, links, Chrom | Abdeckblende, Chrom | Heizpatrone DRY, Chrom



Kioto

① Seite 216

Kioto One

① Seite 218

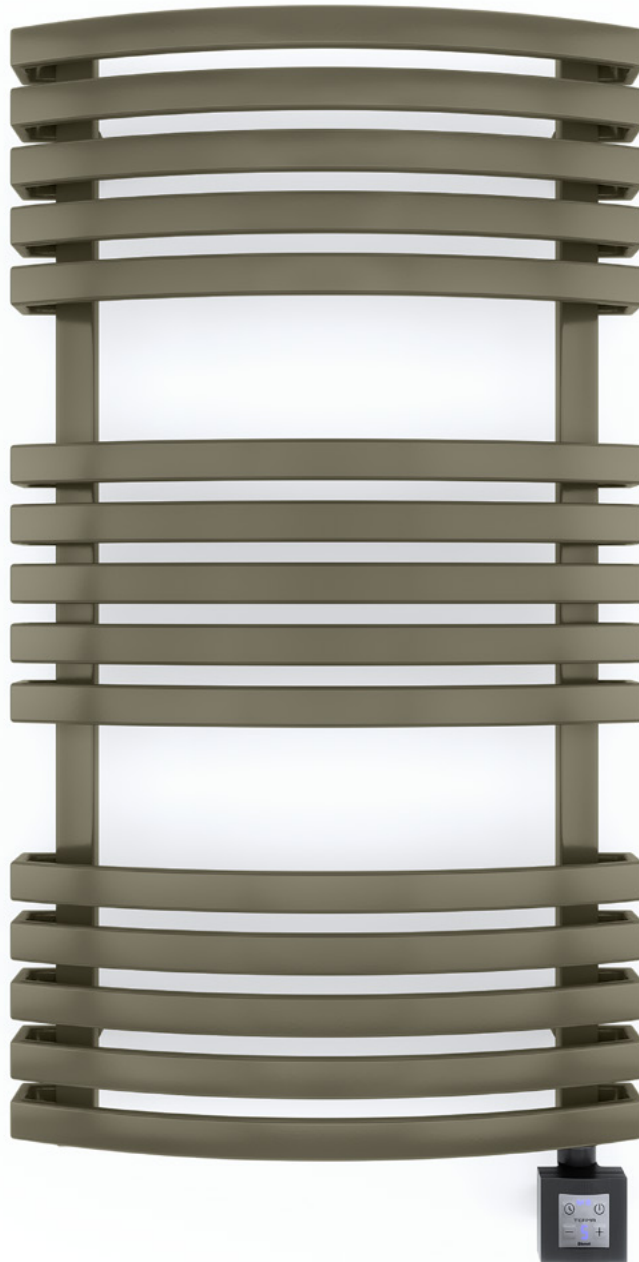

Kioto 870↑ x 480↔ E8

Farbe: RAL 7039

Heizpatronen Steuerung KTX 4 Blue, schwarz





Lena 1620↕ x 586↔ Ø8

Farbe: Metallic Red

Anschlussgarnitur: Set Lanzen-Thermostat-Verbunddeckventil, rechts, Chrom
Abdeckblende, Chrom



Lima ⓘ Seite 226

Lima One ⓘ Seite 232

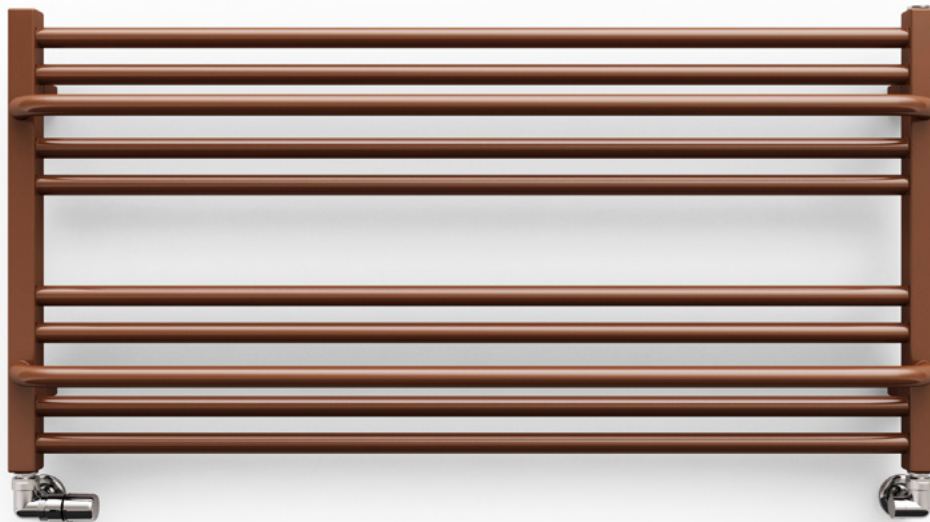

Lima 500↑ x 1000↔ SX
Farbe: RAL 8004

Anschlussgarnitur: Set Winkeleck-Thermostatventil, links, Chrom
Set einteilige Blende, Chrom



Mantis

① Seite 236

Mantis One ① Seite 238

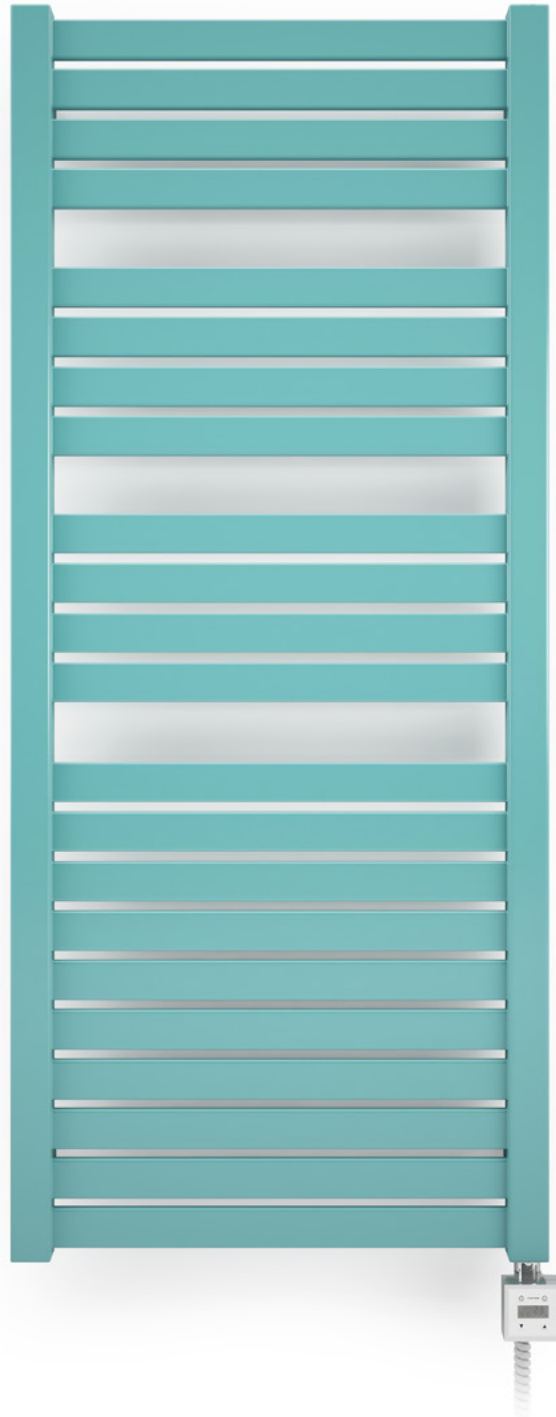

Mantis 1260↑ x 540↔ E8
Farbe: RAL 5018

Heizpatronen Steuerung KTX 3, Chrom



Marlin

① Seite 240

Marlin One ① Seite 244

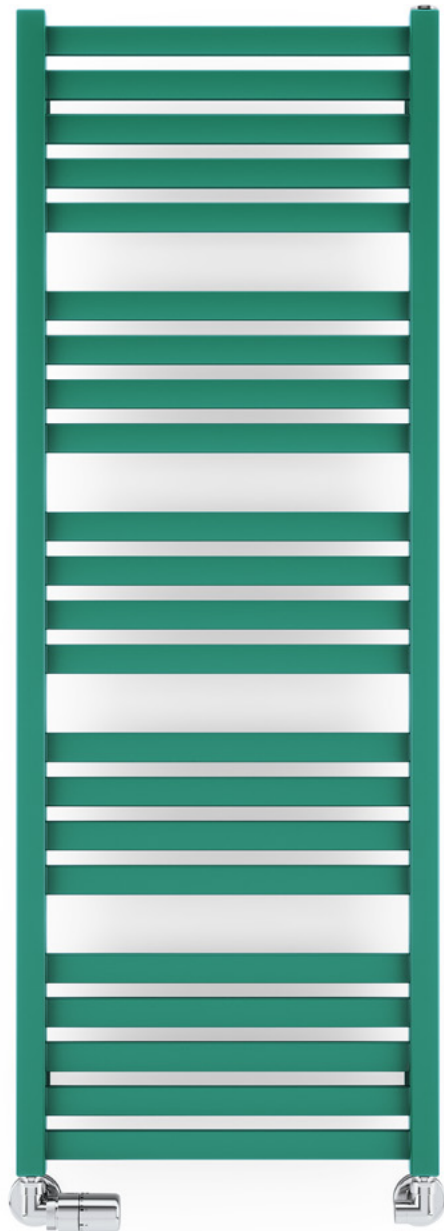

Marlin 1185↑ x 430↔ SX
Farbe: RAL 6000

Anschlussgarnitur: Set Winkeleck-Thermostatventil, links, Chrom
Set einteilige Blende, Chrom



Michelle

📄 Seite 248

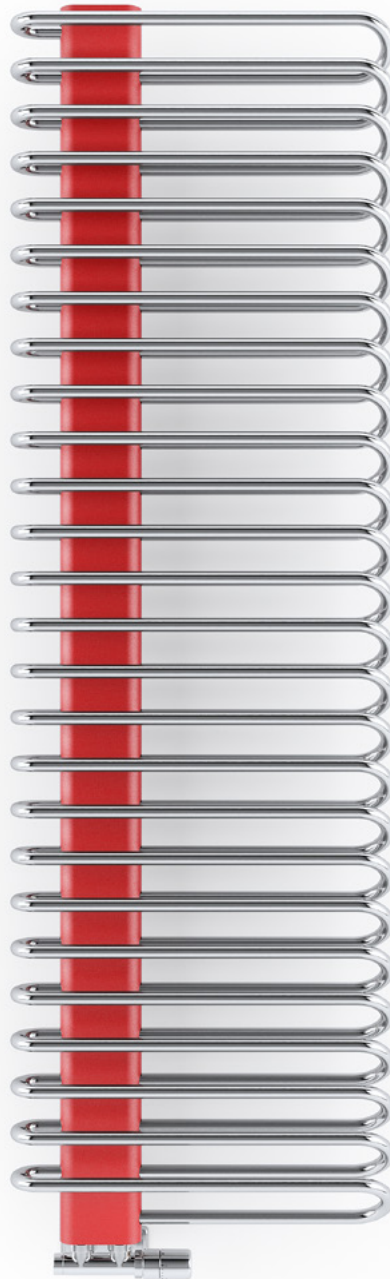

Michelle 1620↕ x 500↔ YL

Farbe: Chrom, Abdeckblende Farbe: Metallic Red

Anschlussgarnitur: Set Thermostat Verbunddeckventil, links, Chrom
Abdeckblende, Chrom

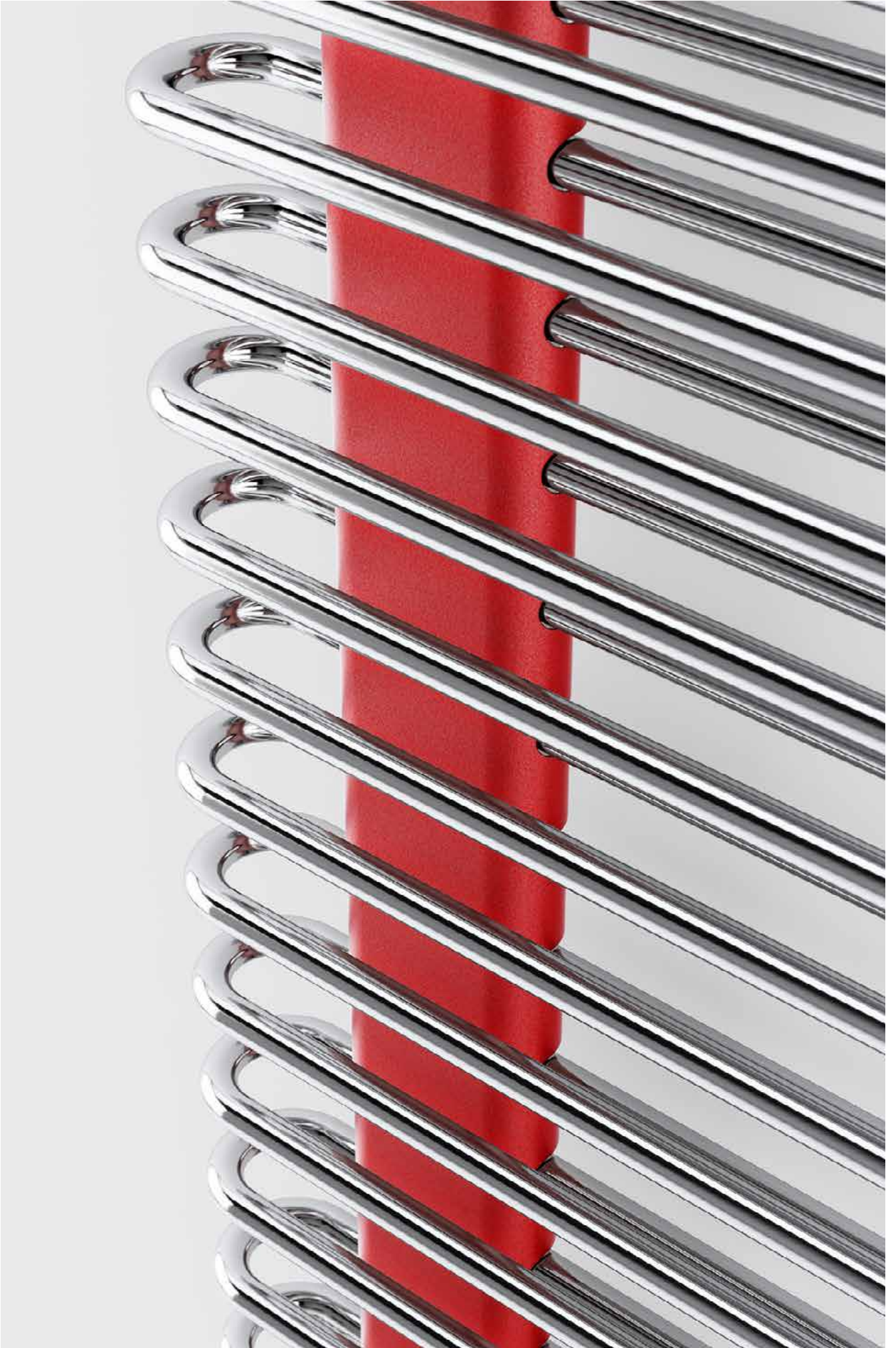



Michelle 1200↕ x 500↔ YL |
Copper (Abdeckblende Farbe:
RAL 6000) | Anschlussgarnitur: Set
Thermostat Verbunddeckventil, links,
Chrom | Abdeckblende, Chrom |
Heizpatrone MOA Blue, Chrom



Mike

① Seite 250

Mike One

① Seite 254

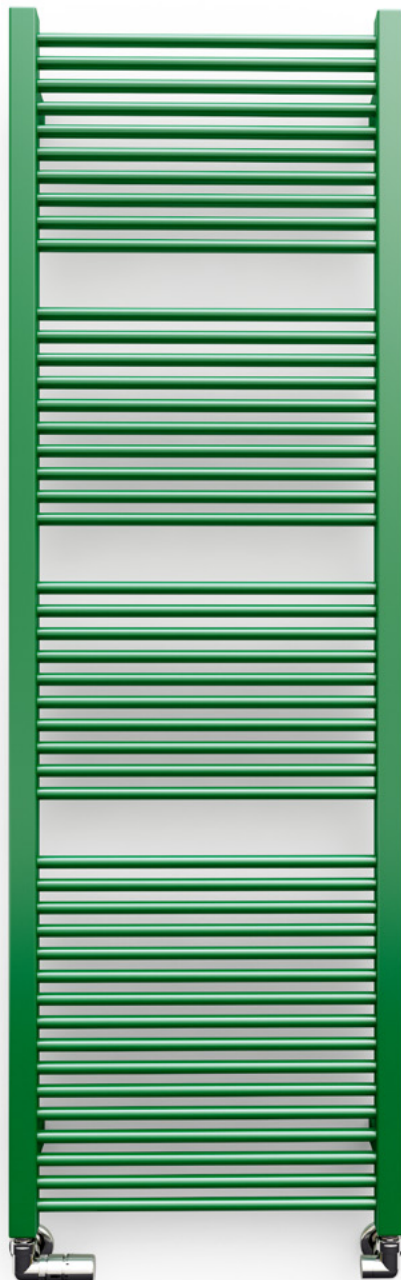

Mike 1335 ↑ x 530 ↔ SX

Farbe: RAL 6029

Anschlussgarnitur: Set Winkeleck-Thermostatventil, Chrom

Set einteilige Blende, Chrom

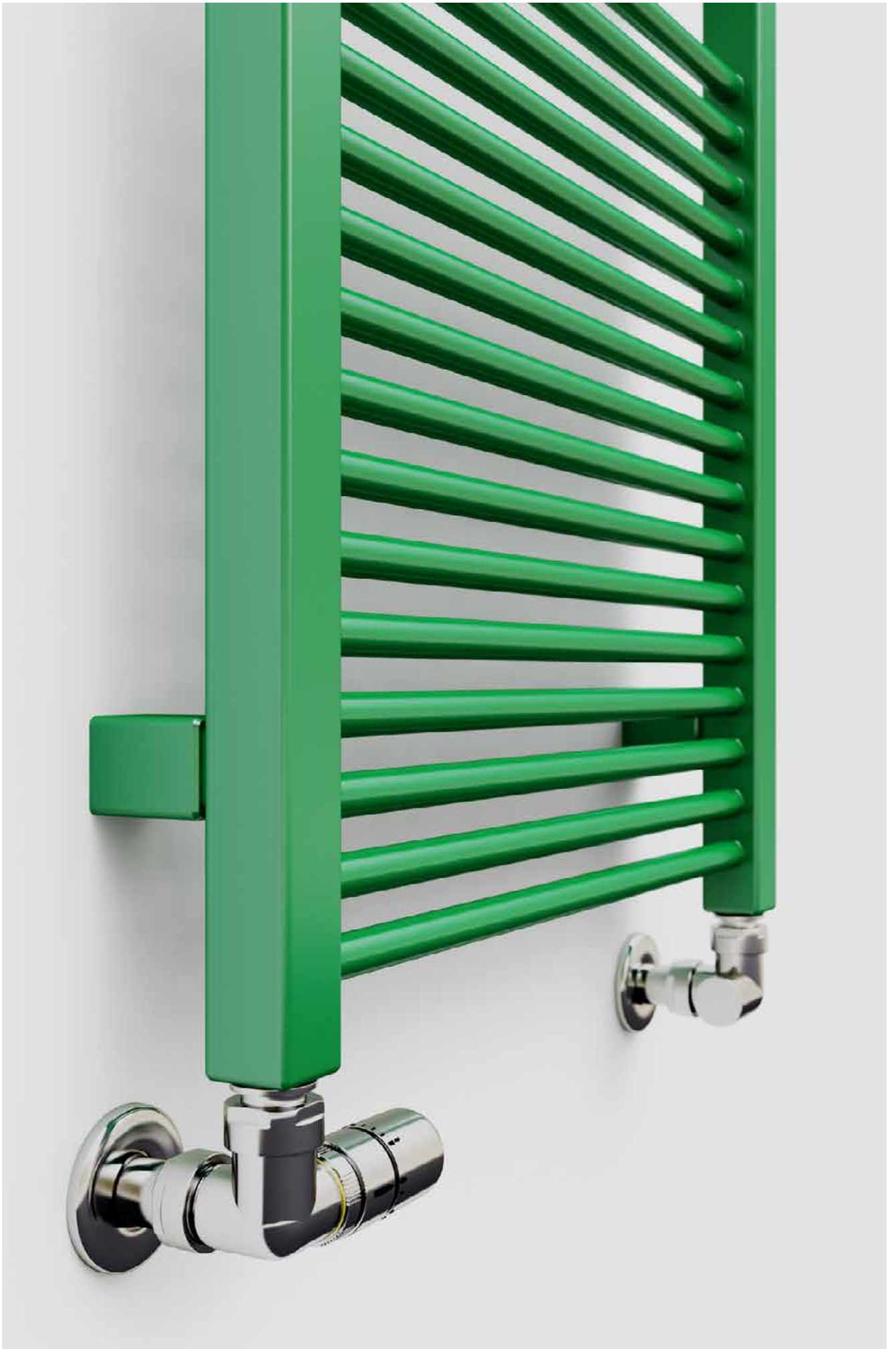



Mike 1335↑ x 530↔ E8 |
Soft 9016 | externe Heizpa-
trone ONE Profil 30x30



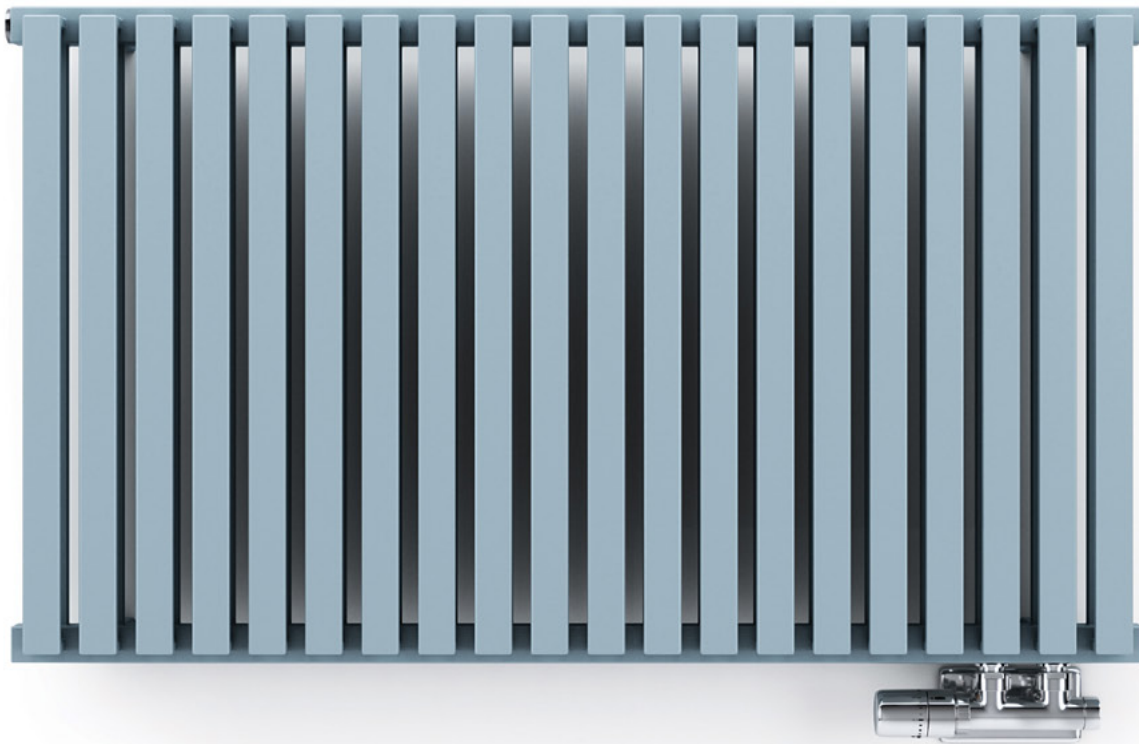

Nemo 530↑ x 915↔ YP

Farbe: Pastel Blue

Anschlussgarnitur: Set Thermostat Verbunddeckventil, rechts, Chrom
Abdeckblende, Chrom



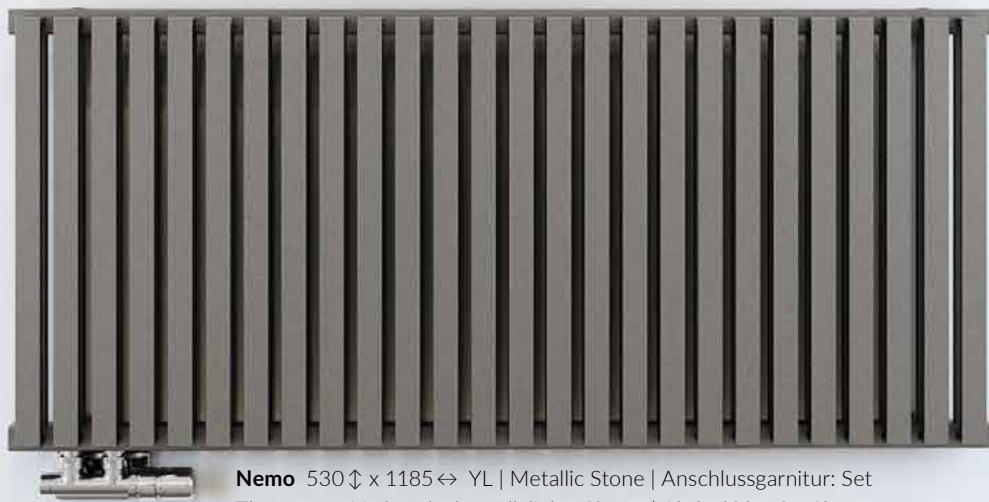

Nemo 530 ↑ x 1185 ↔ YL | Metallic Stone | Anschlussgarnitur: Set
Thermostat Verbunddeckventil, links, Chrom | Abdeckblende, Chrom

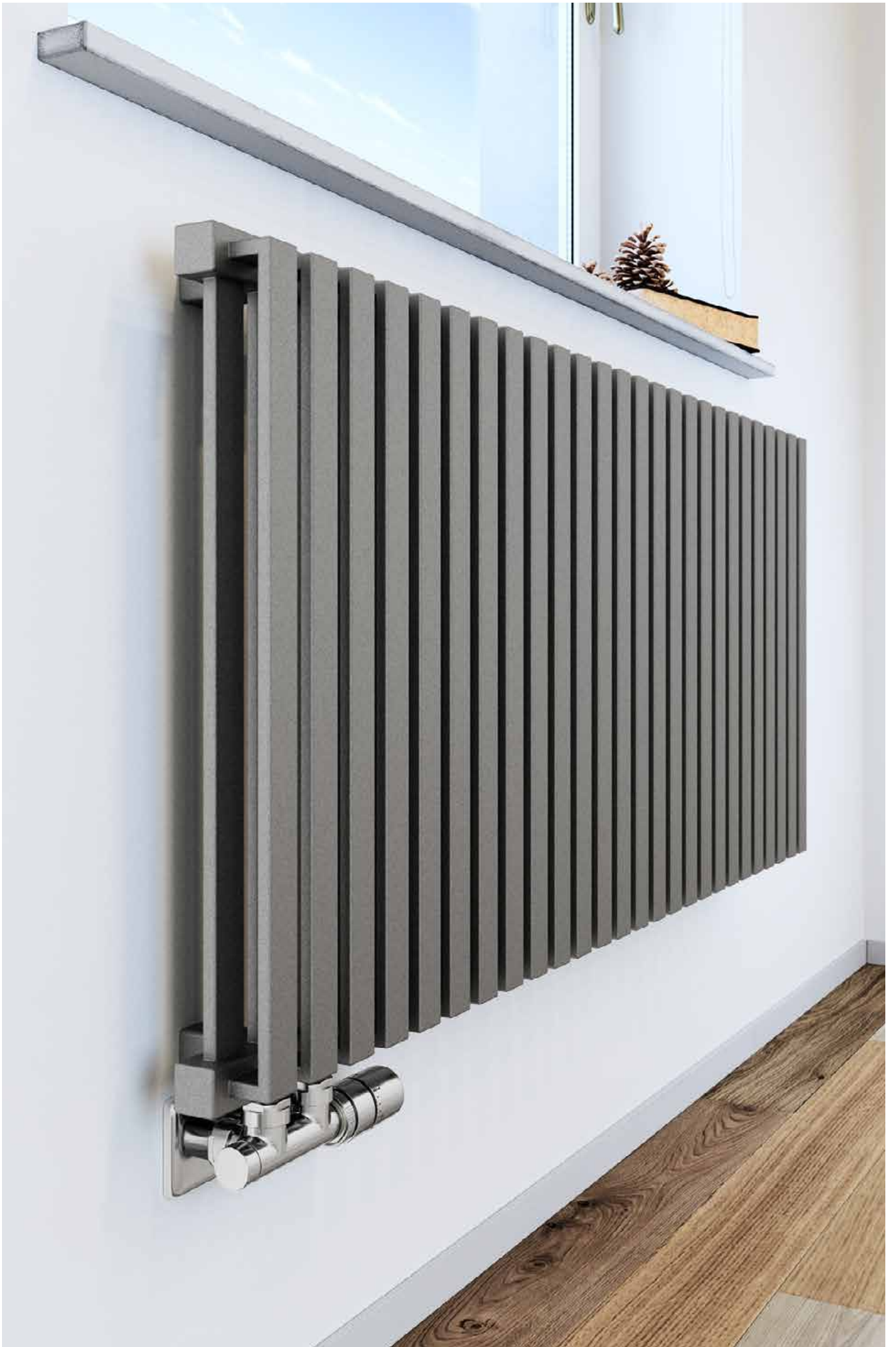

Outcorner

① Seite 262

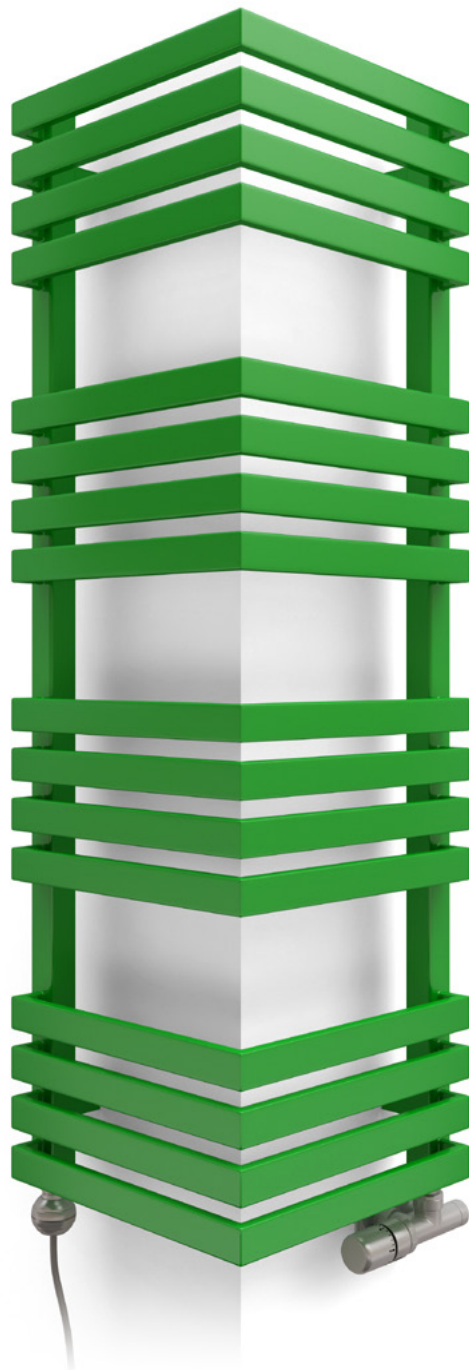

Outcorner 1005 ↓ x 300 ↔ SX
Farbe: RAL 6037

Anschlussgarnitur: Set Lanzen-Thermostat-Verbunddeckventil, rechts, Satiniert
Heizpatrone REG 2 Silber
Abdeckblende, Satiniert



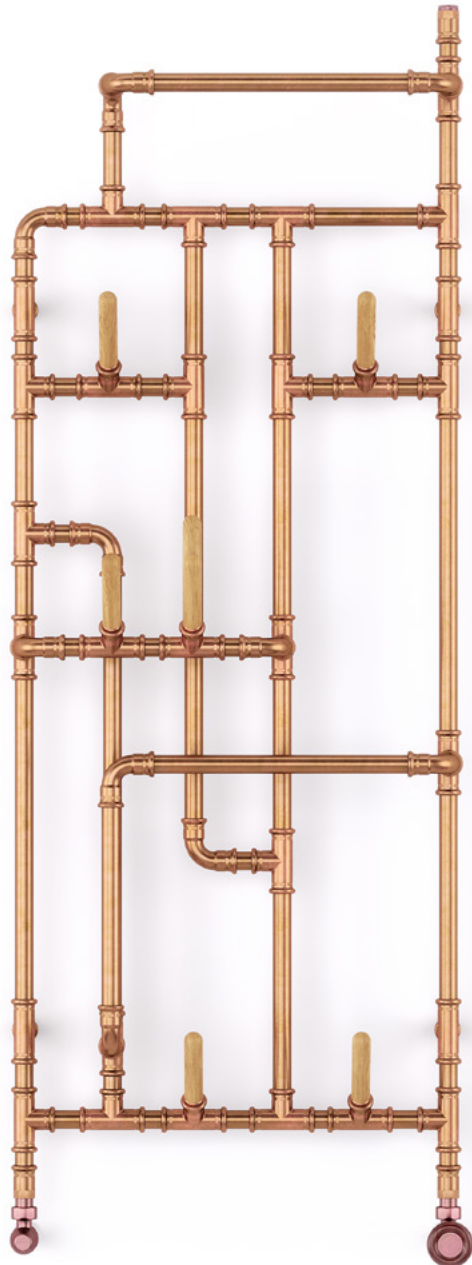

Pajak 1400 \updownarrow x 531 \leftrightarrow SX
Heizung aus Kupferrohr

Anschlussgarnitur: Set Regel-Eckventil Brass Wood
Handtuchhalter aus Holz.





Perla 1760↑ x 600↔ ZX
Farbe: Chrom

Anschlussgarnitur: 2 x Absperr-Eckventil, Chrom
Thermostatkopf Slim, Chrom
Abdeckblende, Chrom



POC 2

① Seite 268

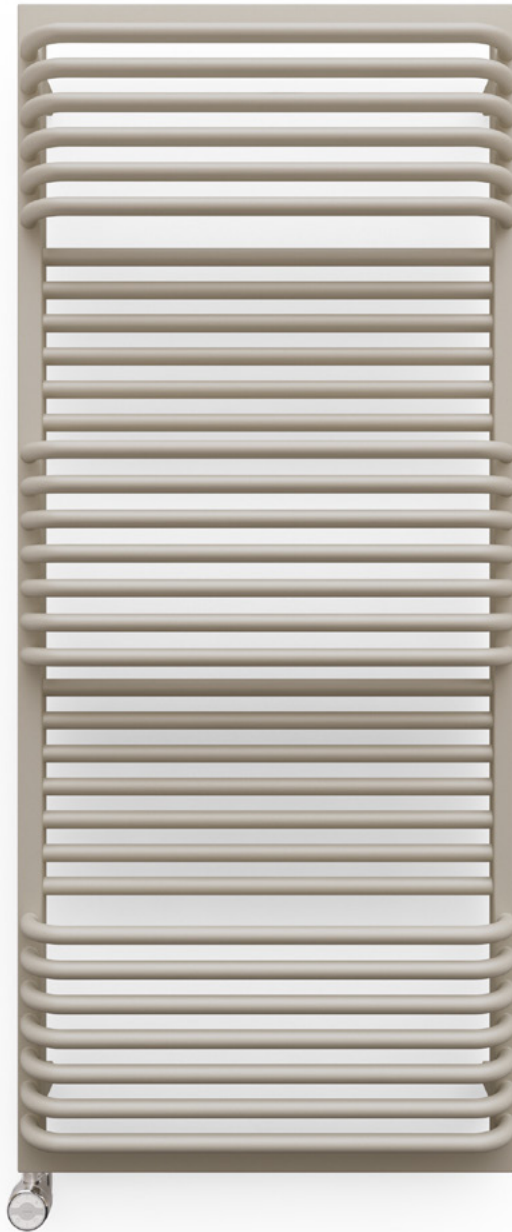

POC 2 1400↑ x 600↔ E1
Farbe: california beige

Heizpatrone MOA, Chrom







POC2 1400↑ x 600↔ SX
| RAL 6033 | Anschlussgarnitur:
Set Lanzen-Thermostat-
Verbunddeckventil, rechts, Chrom
| Abdeckblende, Chrom | Heiz-
patronen Steuerung KTX 3, Chrom

Pola

① Seite 272

Pola One ① Seite 274

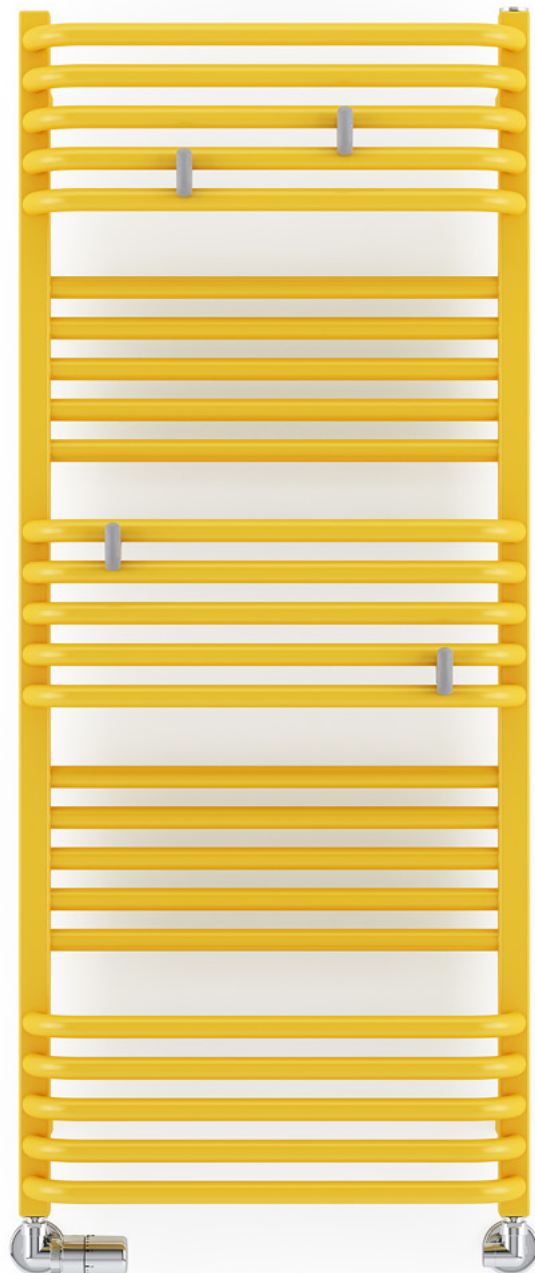

Pola 1180⇕ x 500⇔ SX
Farbe: Soft 1023

Anschlussgarnitur: Set Regel-Eckventil, Chrom
Set einteilige Blende, Chrom
Handtuchhalter Yo! Grau





POLA 1580↑ x 600⇔ E8
| Lavender | externe Heizpa-
trone ONE Profil 30x30



Quadrus Bold

① Seite 276

Quadrus Bold One ① Seite 278



Quadrus Bold 1185↑ x 450↔ E1
Farbe: RAL 3003

Heizpatrone MOA, Chrom

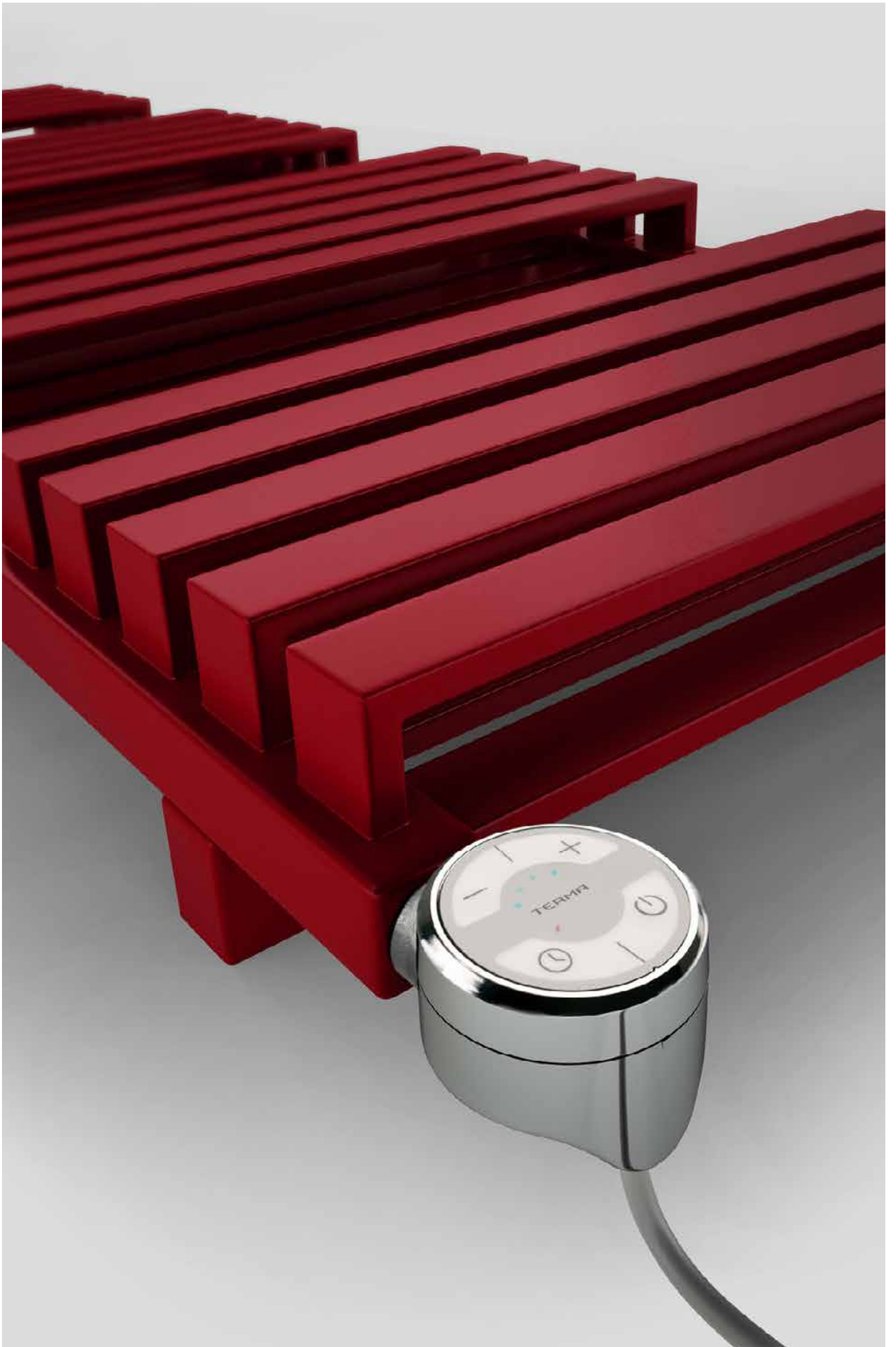



Quadrus Slim One
1185 ↓ x 450 ↔ S1 | Soft
9016 | Anschlussgarnitur:
Set Lanzen-Thermostat-
Verbunddeckventil, rechts,
chrom | Integrierte Heiz-
patrone ONE Profil 30x30



Quadrus Slim

📄 Seite 280

Quadrus Slim One 📄 Seite 282

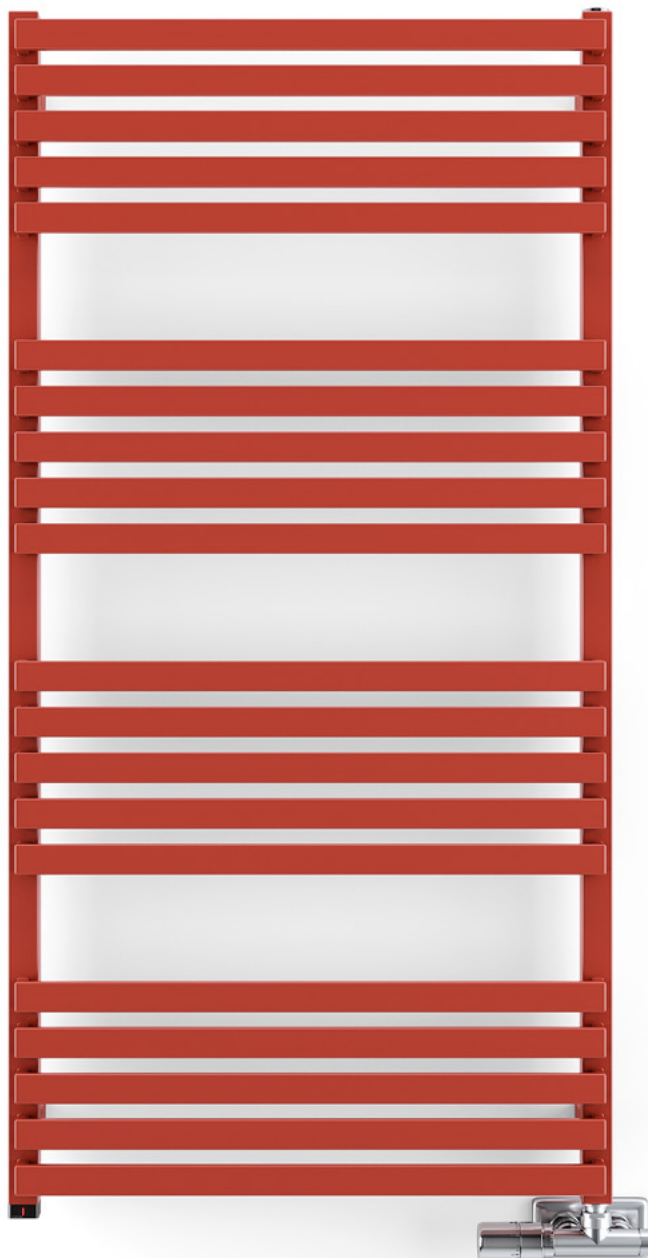

Quadrus Slim One 1185↓ x 600↔ S1
Farbe: Metallic RAL 3013

Anschlussgarnitur: Set Lanzen-Thermostat-Verbunddeckventil, rechts, Chrom
Abdeckblende, Chrom
Integrierte Heizpatrone ONE Profil 30x30





Retro 800↑ x 504↔ SX
Farbe: Chrom

Anschlussgarnitur: Set Regel-Eckventil STAR, Chrom
Set einteilige Blende, Chrom



Ribbon VE

① Seite 286

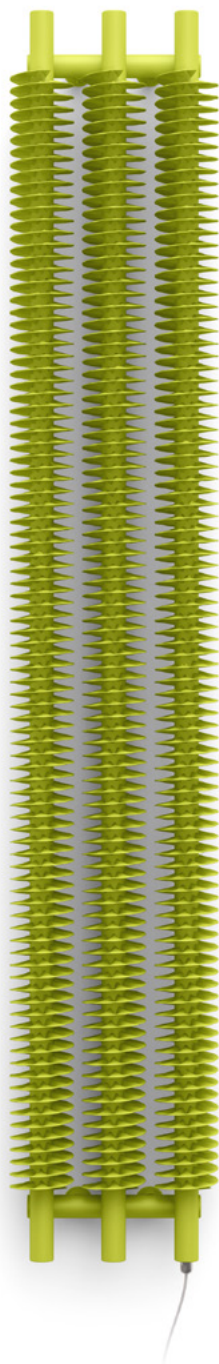

Ribbon VE 1800↑ x 290↔ E8
Farbe: Soft Green Apple

Elektroheizpatrone SIM, Edelstahl

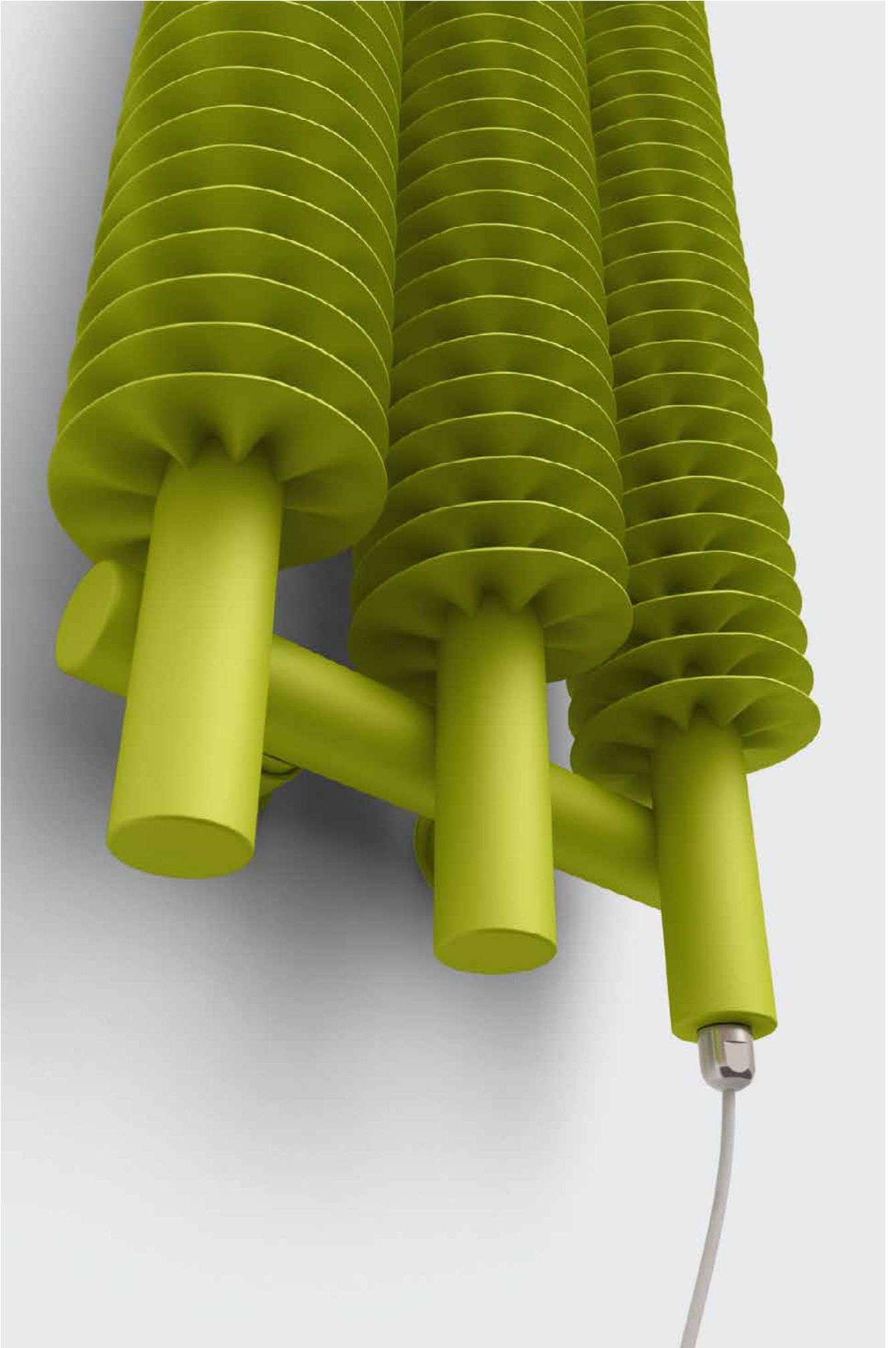

Sherwood V E

① Seite 288



Sherwood V 1900↕ x 440↔ ZX
Farbe: RAL 8014

Anschlussgarnitur: Set Thermostat Verbunddeckventil, links, Chrom
Abdeckblende, Chrom



Triga E

① Seite 290

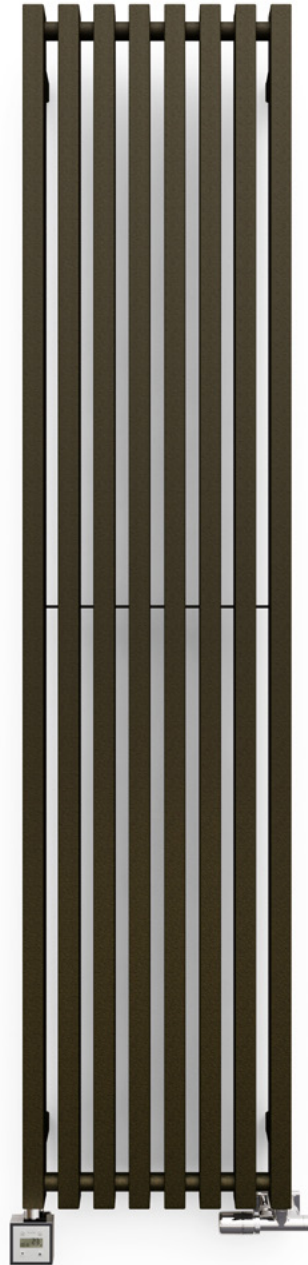

Triga 1900↓ x 380↔ SX
Farbe: Van Gogh

Anschlussgarnitur: Set Lanzen-Thermostat-Verbunddeckventil, rechts, Chrom
Abdeckblende, Chrom
Heizpatronen Steuerung KTX 3, Chrom



Triga M E

① Seite 294



Triga M 1700↓ x 780↔ SX

Farbe: Modern Grey

Anschlussgarnitur: Set Winkeleck-Thermostatventil, links, Chrom

Set einteilige Blende, Chrom



Triga AN E

📄 Seite 296

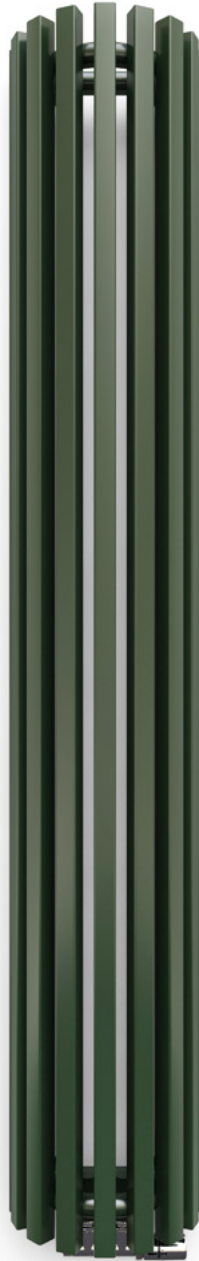

Triga AN 1700↓ x 280↔ ZX
Farbe: RAL 7003

Anschlussgarnitur: Set Thermostat Verbunddeckventil, links, Chrom
Abdeckblende, Chrom



Triga ANC E

Seite 298



Triga ANC 1700↓ x 280↔ YL
Farbe: RAL 5024

Anschlussgarnitur: Set Thermostat Verbunddeckventil, links, Chrom
Abdeckblende, Chrom



Tune VWD E

① Seite 300

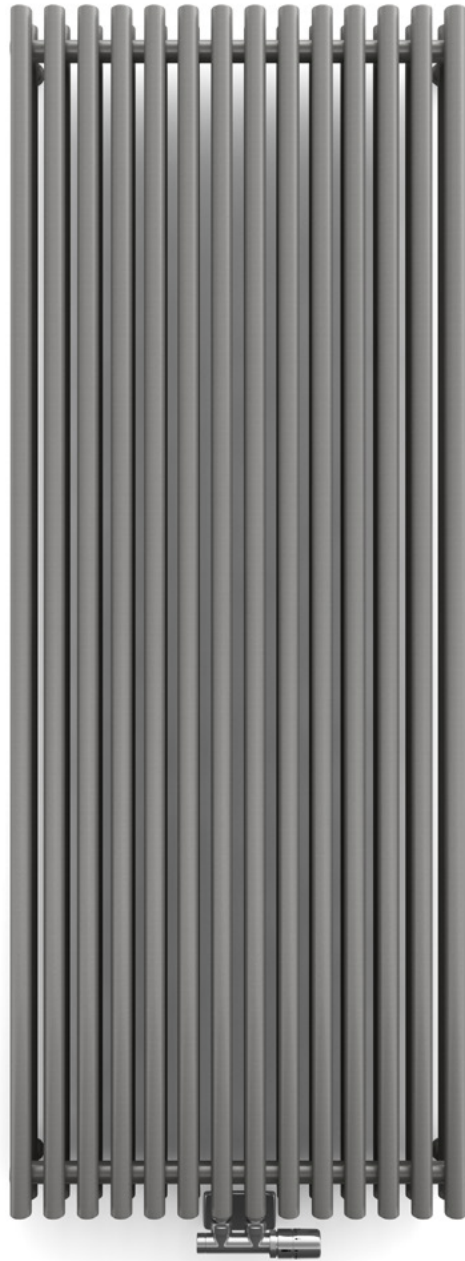

Tune VWD 1800↑ x 690↔ ZX

Farbe: Diamond Silver

Anschlussgarnitur: Set Thermostat Verbunddeckventil, links, Chrom
Abdeckblende, Chrom



Tytus

📄 Seite 304

Tytus One

📄 Seite 306

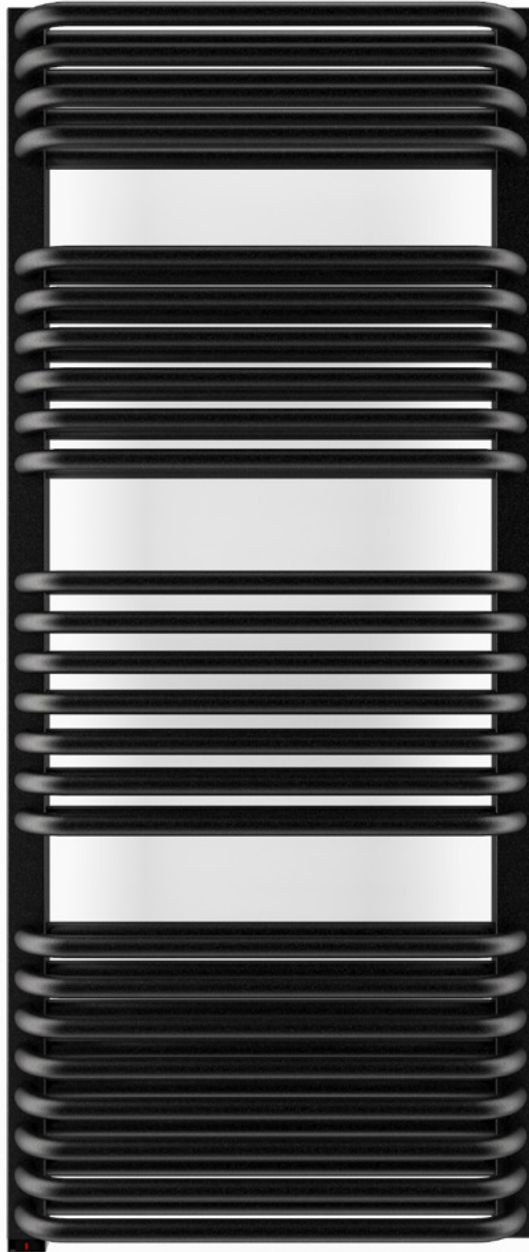

Tytus One 1260↑ x 440↔ E1

Farbe: Black Pepper

Integrierte Heizpatrone ONE Profil 30x40

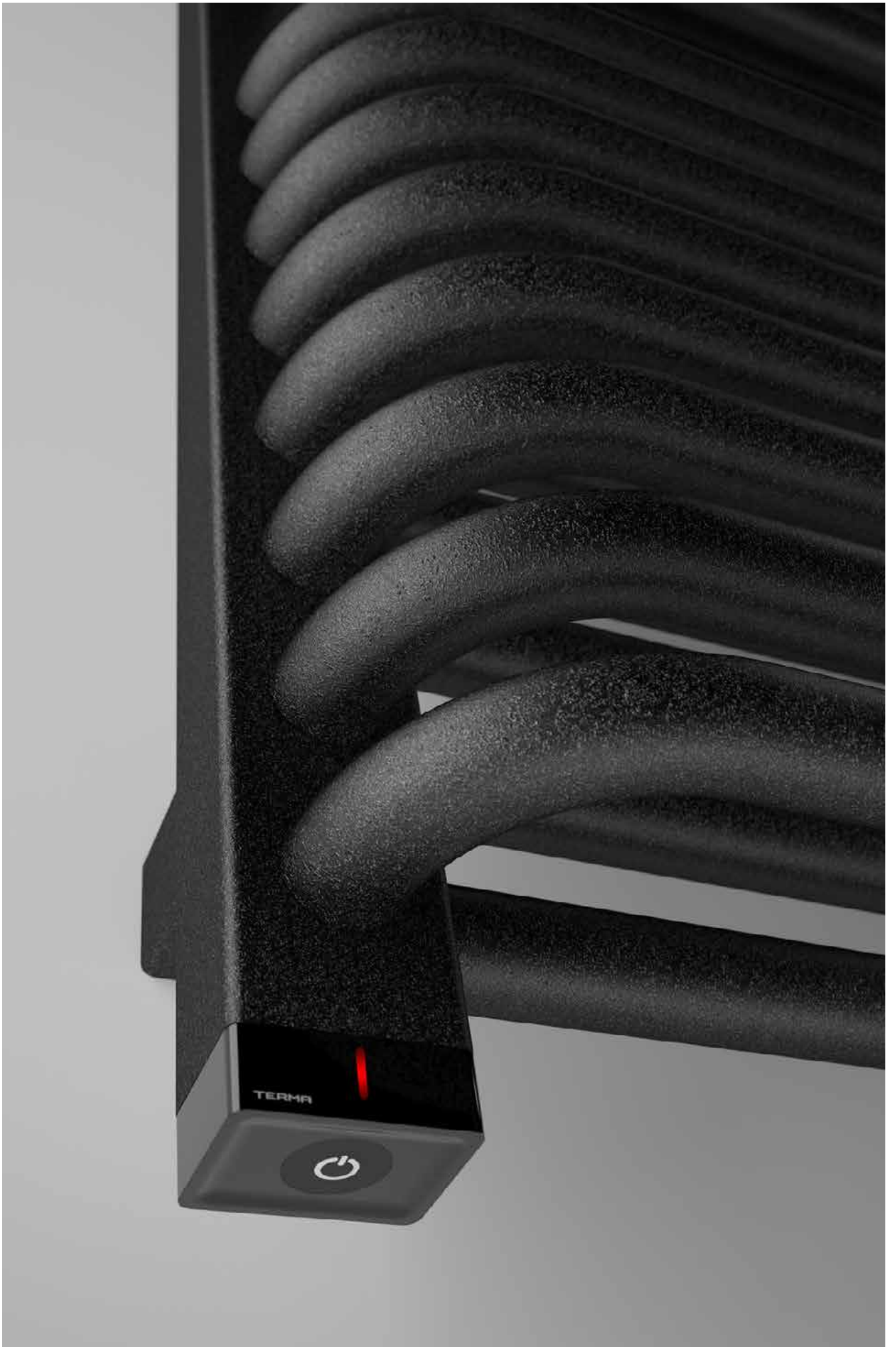

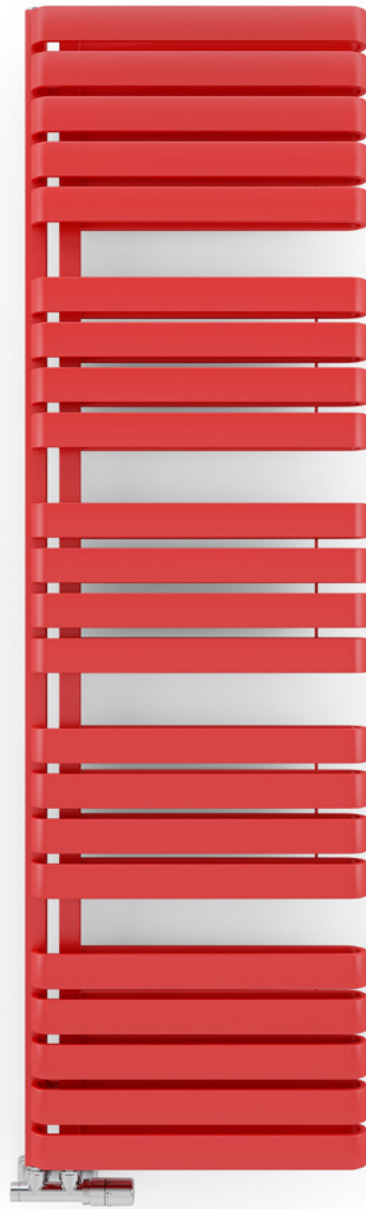

Warp S 1695↕ x 500↔ GD
Farbe: Soft 3028

Anschlussgarnitur: Set Thermostat Verbunddeckventil, links, Chrom
Abdeckblende, Chrom

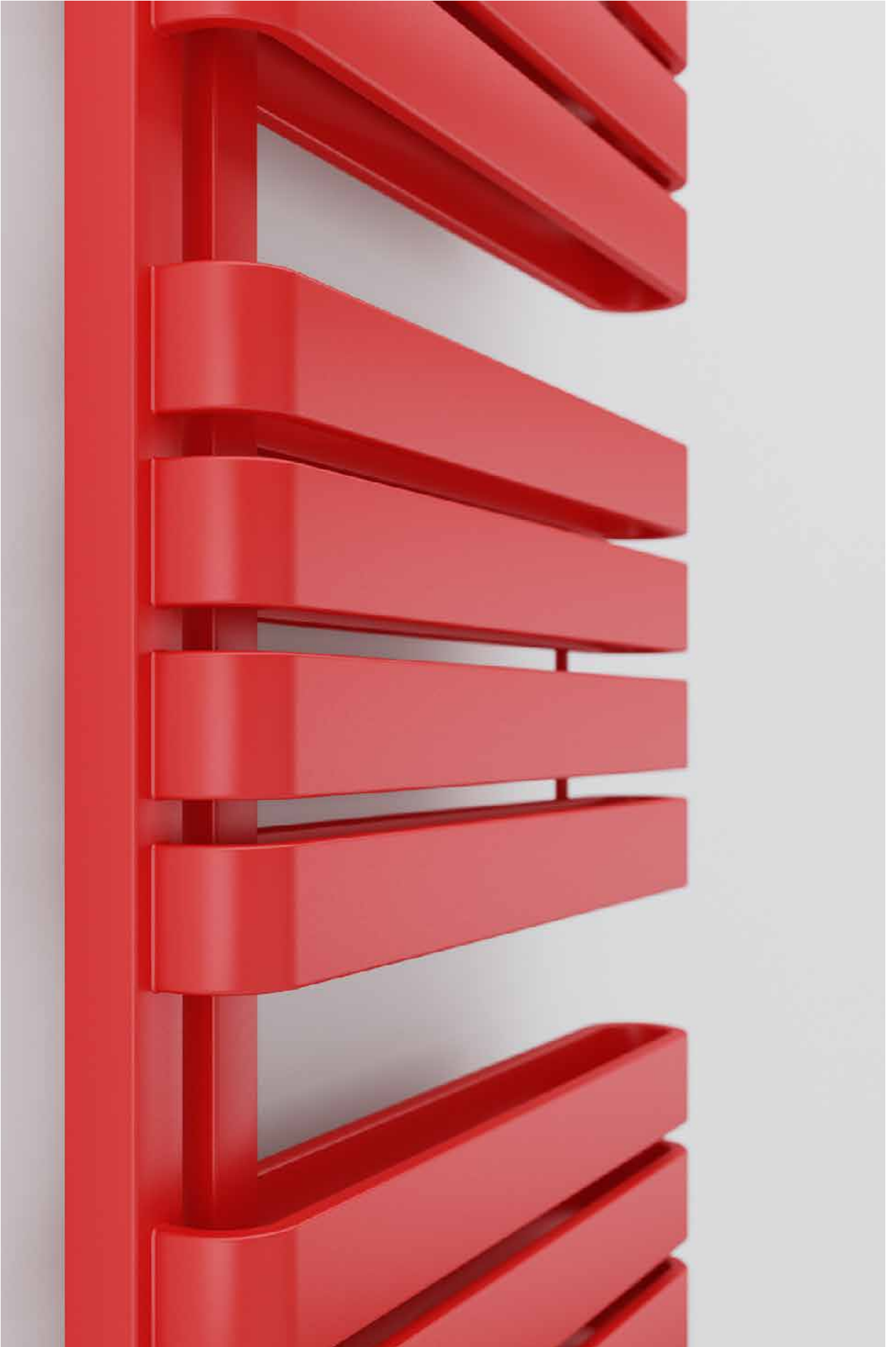



Warp S 1110↓ x 500↔ GD | RAL 1018 |
Anschlussgarnitur: Set Thermostat Verbund-
eckventil, links, Chrom | Abdeckblende,
Chrom



Warp T

① Seite 310

Warp T One ① Seite 312



Warp T 1110⇕ x 500⇔ SX
Farbe: RAL 3028

Anschlussgarnitur: Set Lanzen-Thermostat-Verbunddeckventil, rechts, Chrom
Abdeckblende, Chrom
Heizpatronen Steuerung KTX 1, Chrom

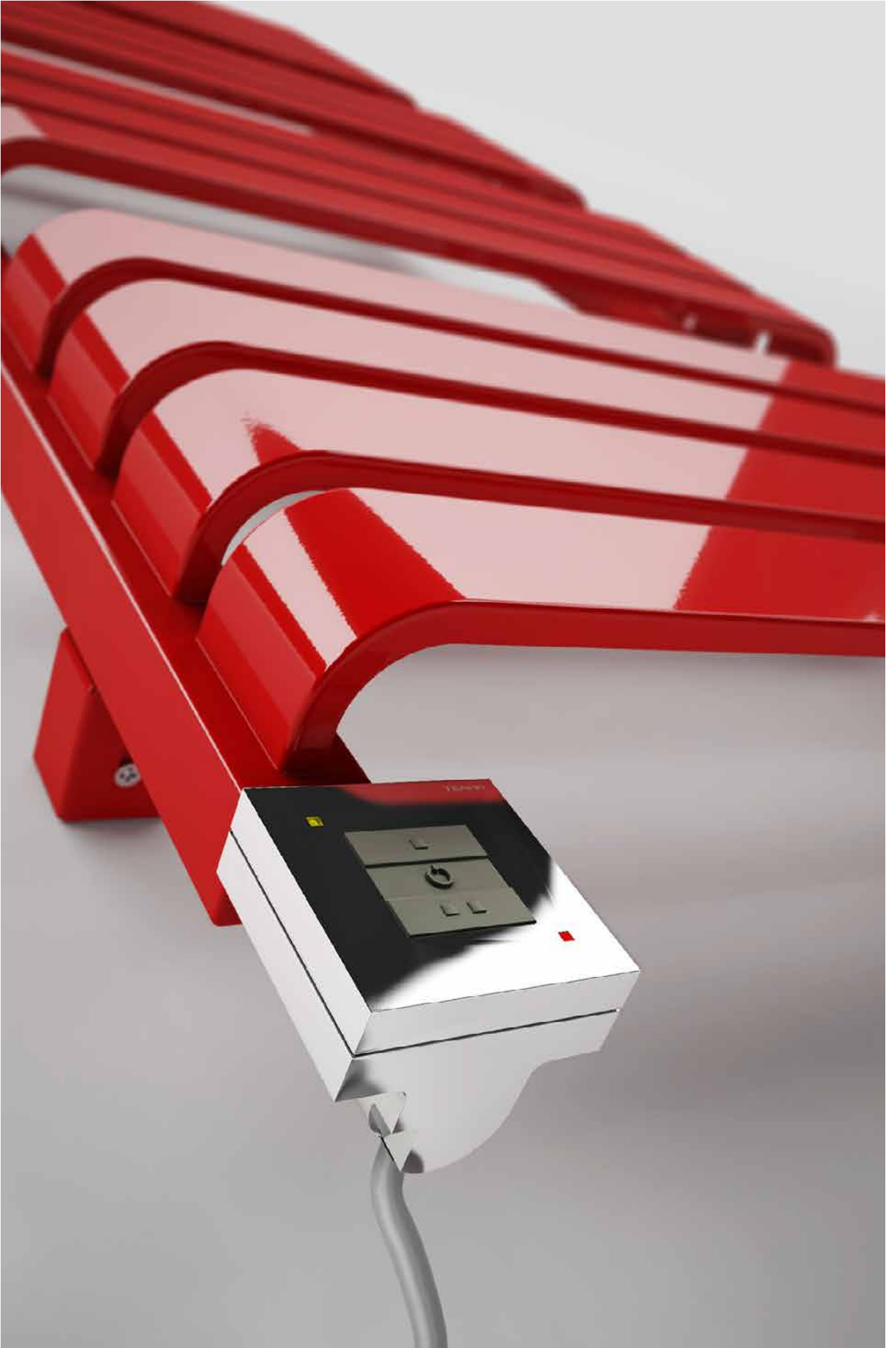

Warp T Bold

📄 Seite 314

Warp T Bold One 📄 Seite 316

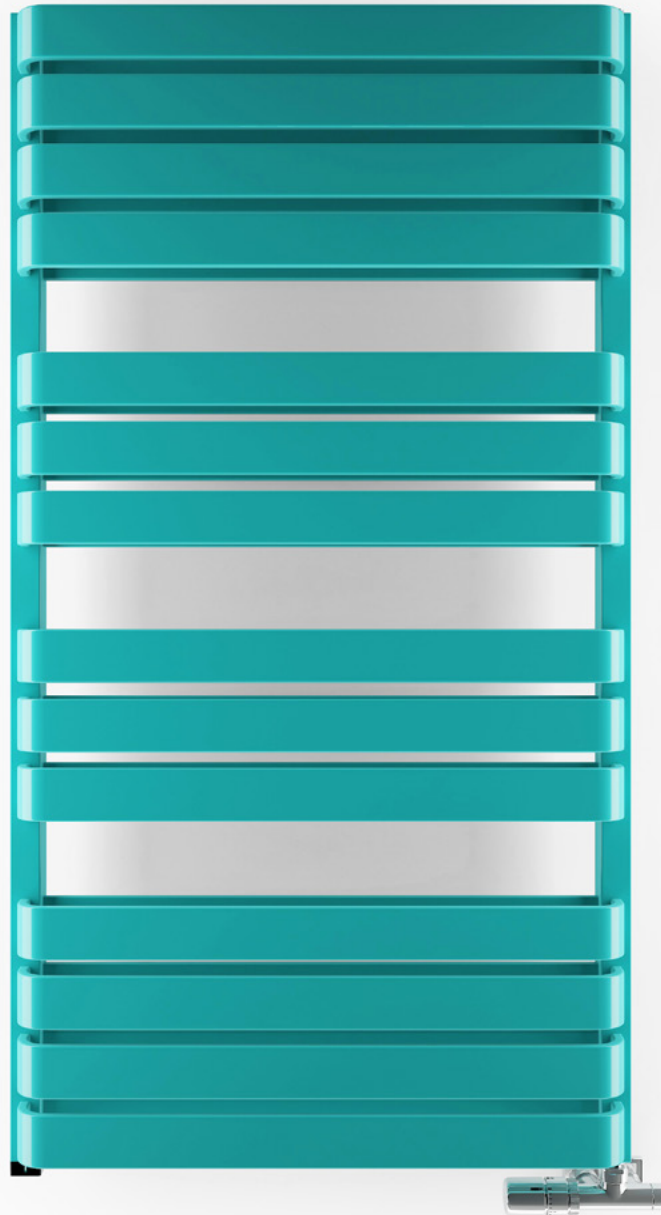

Warp T Bold One 1110↕ x 500↔ S1
Farbe: RAL 5018

Anschlussgarnitur: Set Lanzen-Thermostat-Verbunddeckventil, rechts, Chrom
Abdeckblende Chrom
Integrierte Heizpatrone ONE Profil 30x30





Warp T Bold
1110 ↓ x 500 ↔ O8 |
RAL 7002 | Anschluss-
garnitur: Lanzen-Ther-
mostat-Verbundek-
ventil, rechts, Chrom |
Abdeckblende, Chrom





ZigZag 835 \updownarrow x 500 \leftrightarrow Z8

Farbe: Gold Gloss

Anschlussgarnitur: Set Thermostat Verbunddeckventil, links, Chrom

Abdeckblende, Chrom

Steuerung KTX 4 Chrom

Handtuchhalter ZIP V 30 Chrom





ZigZag 1545 ↓ x 500 ↔ SX | metallic red | Anschlussgarnitur: Set Lanzen-Thermostat-Verbunddeckventil, rechts, Chrom | Abdeckblende, Chrom | Heizpatrone MOA, Chrom

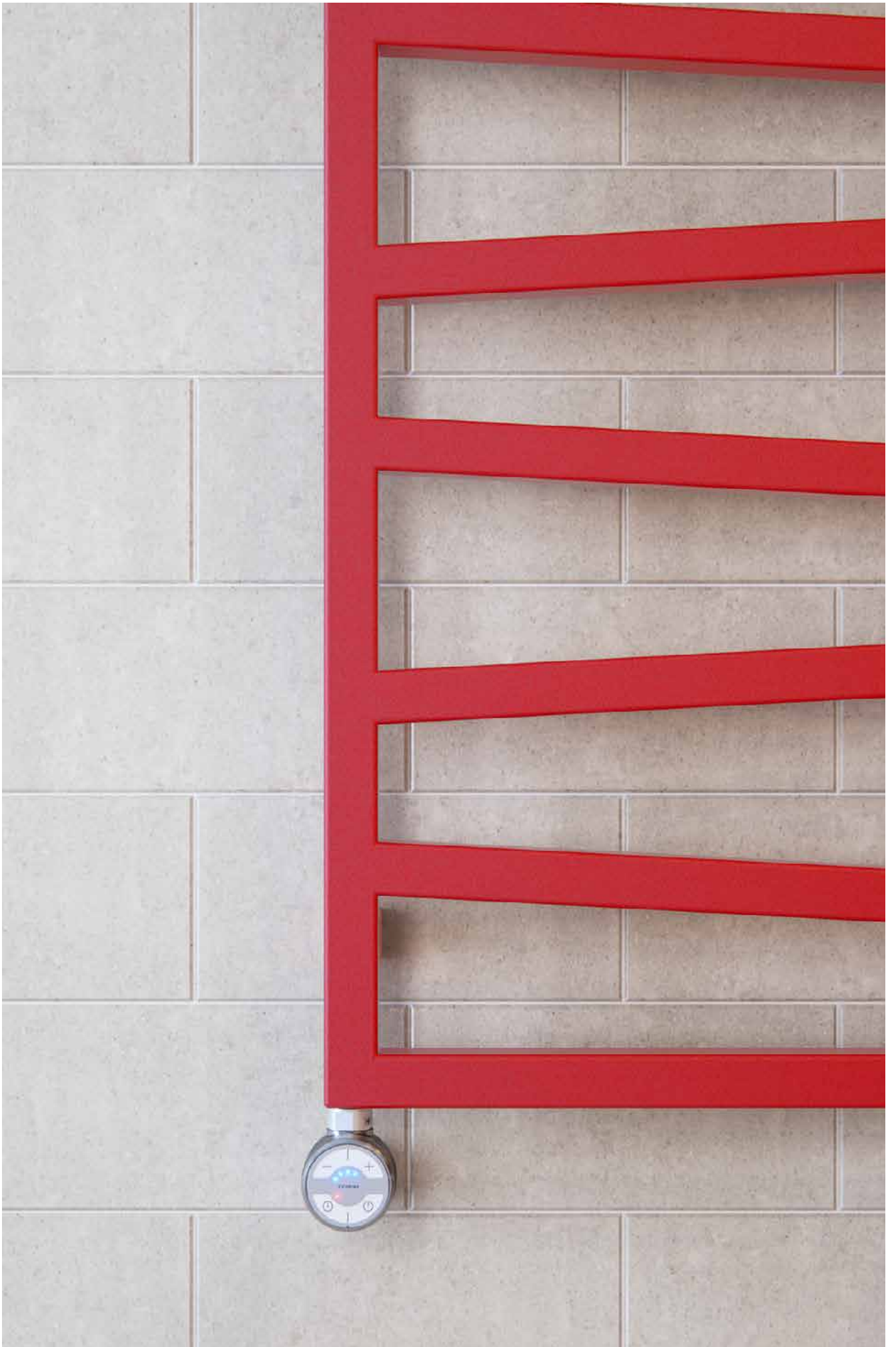

Heizkörper

Technische Informationen



Standard Anschlussstypen:

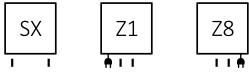

Elektroheizkörper siehe Seite 321

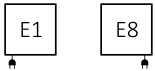

Weitere mögliche Anschlussstypen:

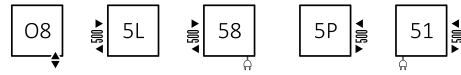
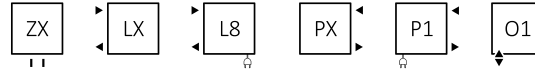

Verfügbare Größen:

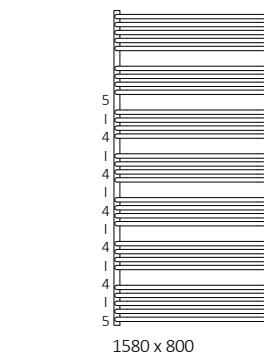
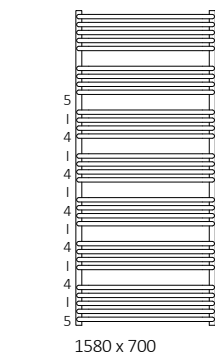
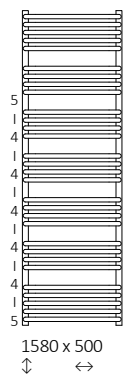
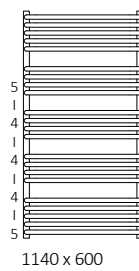
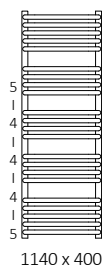
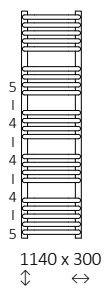
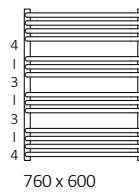
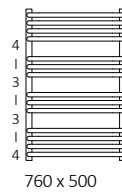
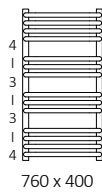
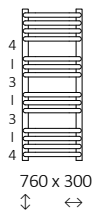
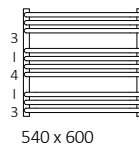
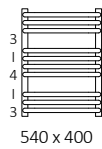
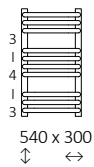

Wir empfehlen: Set Winkeleck-Thermostat-ventil für Anschluss SX



Set einteilige Blende



Heizpatrone MOA



Handtuchhalter Yo!



Technische Daten:

Betriebsdruck: 1000 kPa

Maximale Betriebstemperatur: 95°C

A ↓ [mm]	B ↔ [mm]	C1 [mm]	C2 [mm]	75/65/20°C [W]	55/45/20°C [W]	Ⓢ [W]	D [mm]	E [mm]	F [mm]	H [dm³]	⚖️ [kg]	Artikelnummer <small>(Konfigurations code s. 662)</small>
Pulverlack												
540	300	50	270	180	99	200	270	360	90	1,75	3,71	WGALE054030
540	400	50	370	238	129	200	370	360	90	2,04	4,38	WGALE054040
540	500	50	470	299	161	300	470	360	90	2,32	5,04	WGALE054050
540	600	50	570	355	190	400	570	360	90	2,60	5,71	WGALE054060
760	300	50	270	257	138	300	270	580	90	2,46	5,15	WGALE076030
760	400	50	370	330	177	300	370	580	90	2,85	6,08	WGALE076040
760	500	50	470	412	220	400	470	580	90	3,25	7,02	WGALE076050
760	600	50	570	481	257	600	570	580	90	3,65	7,95	WGALE076060
1140	300	50	270	362	194	400	270	960	90	3,78	7,86	WGALE114030
1140	400	50	370	479	257	400	370	960	90	4,41	9,33	WGALE114040
1140	500	50	470	591	313	600	470	960	90	5,03	10,8	WGALE114050
1140	600	50	570	711	380	800	570	960	90	5,65	12,27	WGALE114060
1580	500	50	470	793	425	800	470	1400	90	6,90	14,74	WGALE158050
1580	600	50	570	949	508	1000	570	1400	90	7,75	16,75	WGALE158060
1580	700	50	670	1104	591	1000	670	1400	90	8,60	18,75	WGALE158070
1580	800	50	770	1253	670	1200	770	1400	90	9,45	20,76	WGALE158080
Galvanische Oberfläche												
540	300	50	270	126	64	120	270	360	90	1,75	3,57	WGALE054030
540	400	50	370	167	85	200	370	360	90	2,04	4,21	WGALE054040
540	500	50	470	209	107	200	470	360	90	2,32	4,85	WGALE054050
540	600	50	570	249	127	300	570	360	90	2,60	5,49	WGALE054060
760	300	50	270	180	92	200	270	580	90	2,46	4,95	WGALE076030
760	400	50	370	231	118	200	370	580	90	2,85	5,85	WGALE076040
760	500	50	470	288	147	300	470	580	90	3,25	6,74	WGALE076050
760	600	50	570	337	172	400	570	580	90	3,65	7,64	WGALE076060
1140	300	50	270	253	129	300	270	960	90	3,78	7,56	WGALE114030
1140	400	50	370	335	171	400	370	960	90	4,41	8,97	WGALE114040
1140	500	50	470	414	211	400	470	960	90	5,03	10,38	WGALE114050
1140	600	50	570	498	254	600	570	960	90	5,65	11,79	WGALE114060
1580	500	50	470	555	283	600	470	1400	90	6,90	14,17	WGALE158050
1580	600	50	570	664	339	600	570	1400	90	7,75	16,09	WGALE158060
1580	700	50	670	773	394	800	670	1400	90	8,60	18,01	WGALE158070

SX

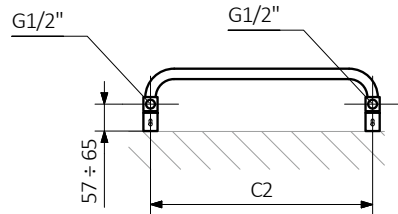

Z1

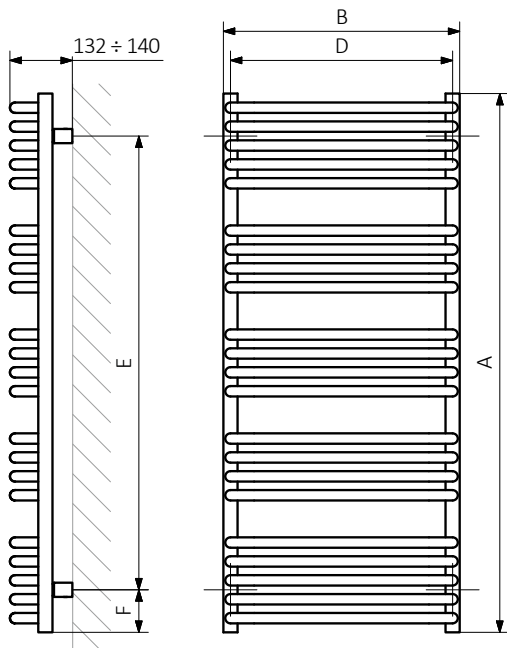
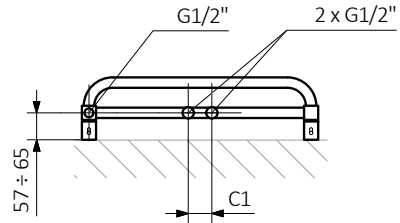

Z8

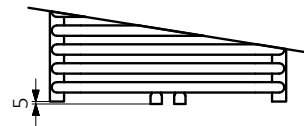
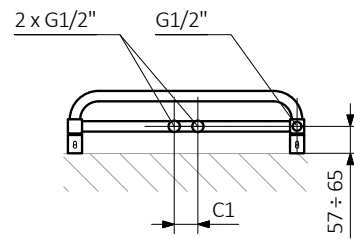

A – Höhe B – Breite C1-C5 – Anschlussabstand D – horizontaler Wandhalterungsabstand E – Vertikaler Wandhalterungsabstand F – Abstand von der Achse der unteren Wandhalterung bis Unterkante des Kollektors

Kollektor:

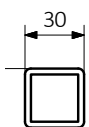

Rohr:

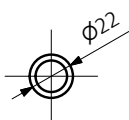

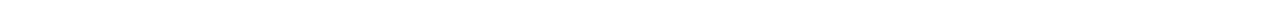



Standard Anschlussstypen:

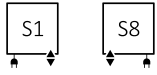

Elektroheizkörper siehe Seite 321

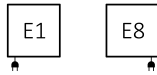

Weitere mögliche Anschlussstypen:

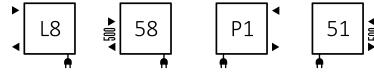

Verfügbare Größen:

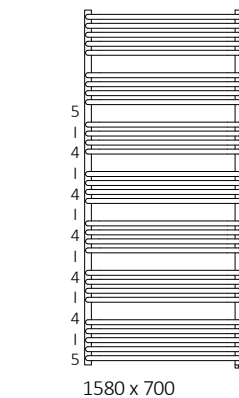
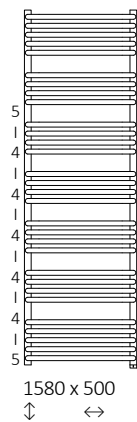
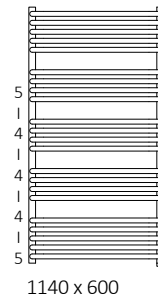
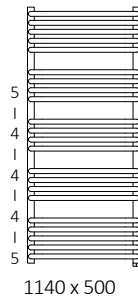
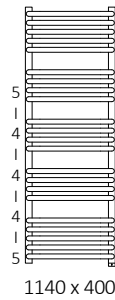
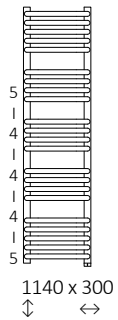
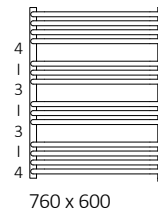
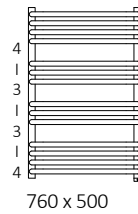
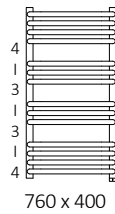
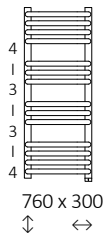

Wir empfehlen: Set Lanzen-Thermostat-Verbund-eckventil für Anschluss S1, S8



Abdeckblende



Technische Daten:

Betriebsdruck: 1000 kPa

Maximale Betriebstemperatur: 82°C

A ↓ [mm]	B ↔ [mm]	75/65/20°C [W]	55/45/20°C [W]	 [W]	D [mm]	E [mm]	F [mm]	 [dm³]	 [kg]	Artikelnummer <small>(Konfigurationscode s. 663)</small>
Pulverlack										
760	300	257	137	300	270	620	70	2,39	5,15	WZALN076030
760	400	330	177	300	370	620	70	2,79	6,08	WZALN076040
760	500	412	220	400	470	620	70	3,19	7,02	WZALN076050
760	600	481	257	600	570	620	70	3,58	7,95	WZALN076060
1140	300	362	194	400	270	1000	70	3,72	7,86	WZALN114030
1140	400	479	257	400	370	1000	70	4,34	9,33	WZALN114040
1140	500	591	313	600	470	1000	70	4,97	10,8	WZALN114050
1140	600	711	380	800	570	1000	70	5,59	12,27	WZALN114060
1580	500	793	425	800	470	1440	70	6,83	14,74	WZALN158050
1580	600	949	508	1000	570	1440	70	7,68	16,75	WZALN158060
1580	700	1104	591	1000	670	1440	70	8,60	18,75	WZALN158070
Galvanische Oberfläche										
760	300	180	92	200	270	620	70	2,39	4,95	WZALN076030
760	400	231	118	200	370	620	70	2,79	5,85	WZALN076040
760	500	288	147	300	470	620	70	3,19	6,74	WZALN076050
760	600	337	172	400	570	620	70	3,58	7,64	WZALN076060
1140	300	253	129	300	270	1000	70	3,72	7,56	WZALN114030
1140	400	335	171	400	370	1000	70	4,34	8,97	WZALN114040
1140	500	414	211	400	470	1000	70	4,97	10,38	WZALN114050
1140	600	498	254	600	570	1000	70	5,59	11,79	WZALN114060
1580	500	555	283	600	470	1440	70	6,83	14,17	WZALN158050
1580	600	664	339	600	570	1440	70	7,68	16,09	WZALN158060
1580	700	773	394	800	670	1440	70	8,60	18,01	WZALN158070

S1

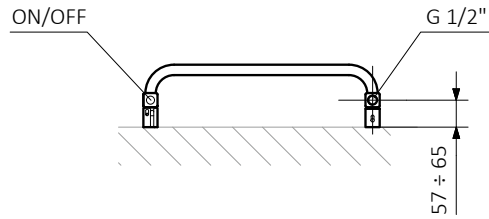

S8

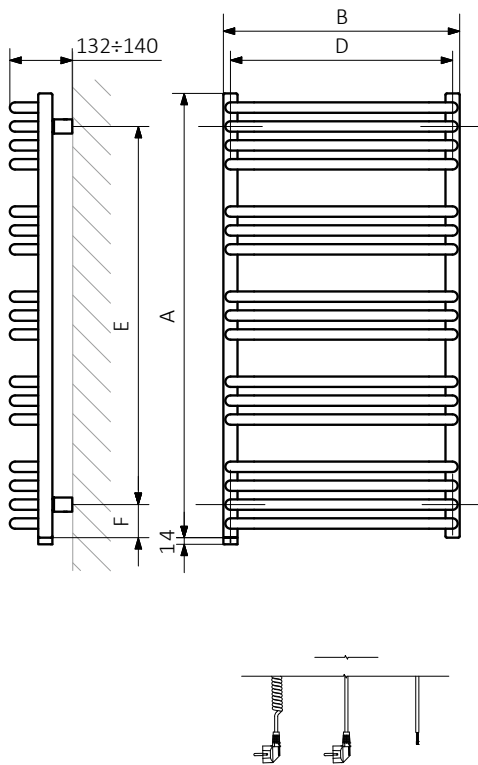
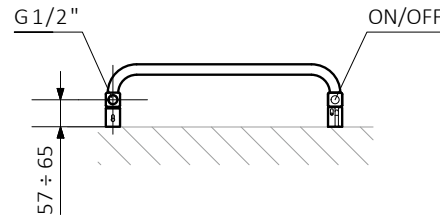

A – Höhe B – Breite C1-C5 – Anschlussabstand D – horizontaler Wandhalterungsabstand E – Vertikaler Wandhalterungsabstand
F – Abstand von der Achse der unteren Wandhalterung bis Unterkante des Kollektors

Kollektor:

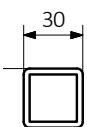

Rohr:

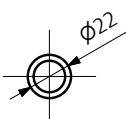

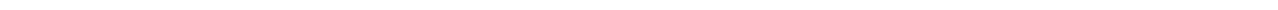



Standard Anschlussstypen:

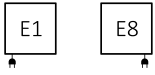

Verfügbare Größen:

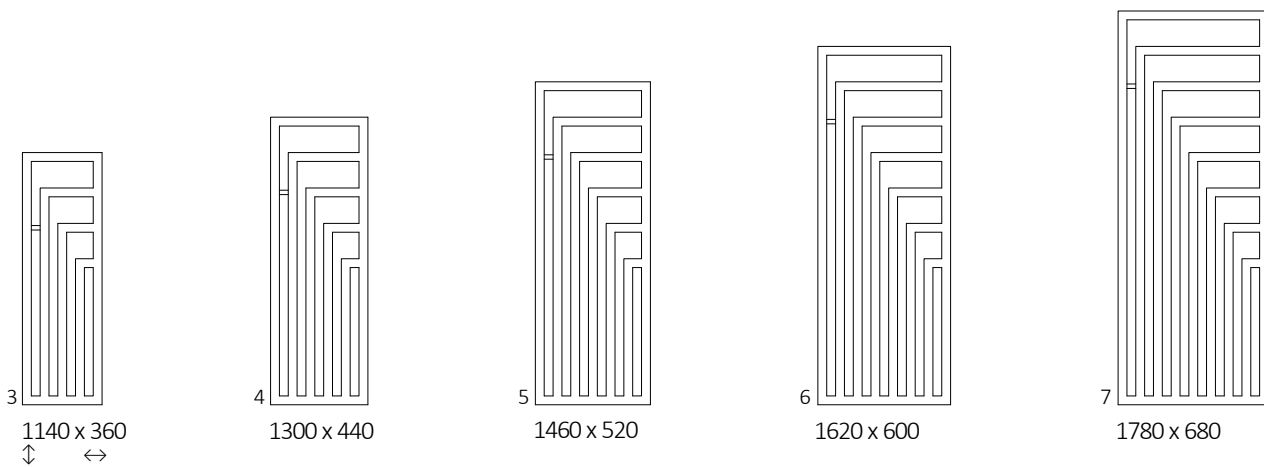

Technische Daten:

A ↓ [mm]	B ↔ [mm]	[W]	D [mm]	E [mm]	F [mm]	[dm³]	[kg]	Artikelnummer <small>(Konfigurations code s. 664)</small>
1140	360	400	320	960	90	5,18	11,5	WLANG114036
1300	440	600	400	1120	90	6,92	15,4	WLANG130044
1460	520	800	480	1280	90	8,88	19,7	WLANG146052
1620	600	1000	560	1440	90	11,07	24,6	WLANG162060
1780	680	1200	640	1600	90	13,48	29,9	WLANG178068

Wir empfehlen: Heizpatronen
Steuerung KTX 4



E8

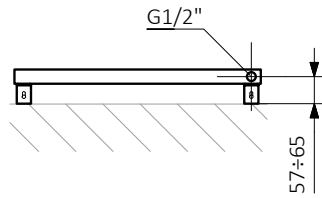

E1

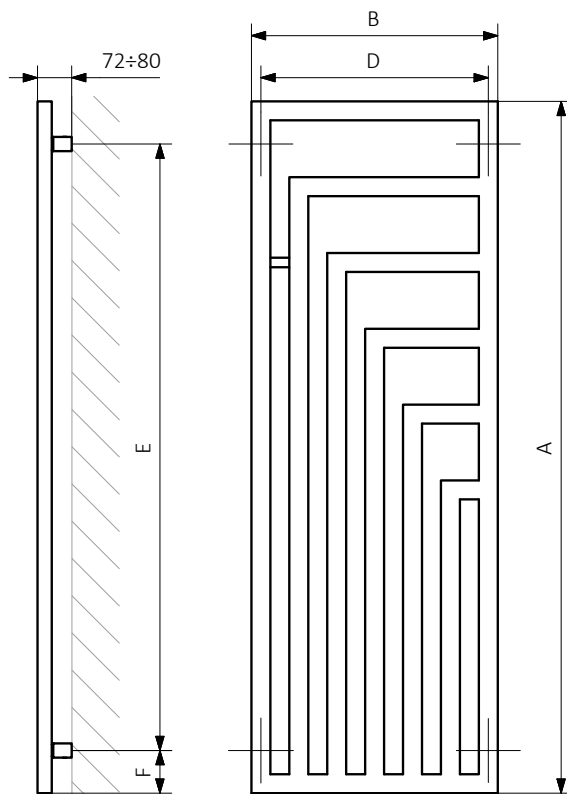
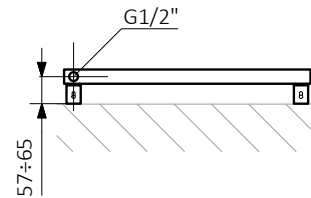

A - Höhe B - Breite C1-C5 - Anschlussabstand D - horizontaler Wandhalterungsabstand E - Vertikaler Wandhalterungsabstand
F - Abstand von der Achse der unteren Wandhalterung bis Unterkante des Kollektors

Rohr:

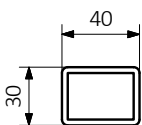



Standard Anschlussstypen:

A \updownarrow 360÷680:

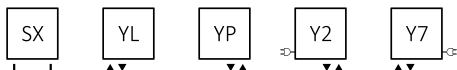

Elektroheizkörper siehe Seite 321



Weitere mögliche Anschlussstypen:

A \updownarrow 360÷680:

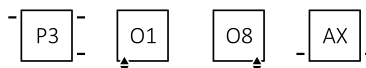
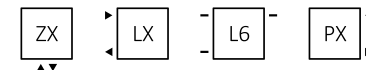

A \updownarrow 600÷680:



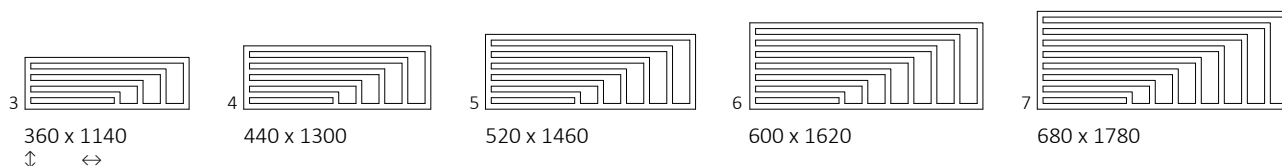

Verfügbare Größen:



Technische Daten:

Betriebsdruck: 800 kPa

Maximale Betriebstemperatur: 95°C

A \updownarrow [mm]	B \leftrightarrow [mm]	C1 [mm]	C2 [mm]	75/65/20°C [W]	55/45/20°C [W]	 [W]	D [mm]	E [mm]	F [mm]	 [dm ³]	 [kg]	Artikelnummer <small>(Konfigurations code s. 662)</small>
360	1140	50	1100	416	227	400	1100	160	100	5,18	11,50	WGANH036114
440	1300	50	1260	538	292	600	1260	240	100	6,92	15,36	WGANH044130
520	1460	50	1420	680	366	800	1420	320	100	8,88	19,71	WGANH052146
600	1620	50	1580	841	449	800	1580	400	100	11,07	24,57	WGANH060162
680	1780	50	1740	1022	540	1000	1740	480	100	13,48	29,92	WGANH068178

Wir empfehlen: Set Thermostat Verbundventil für Anschluss YL, YP, Y1 und Y8



Abdeckblende



Heizpatronen Steuerung KTX 3



YP

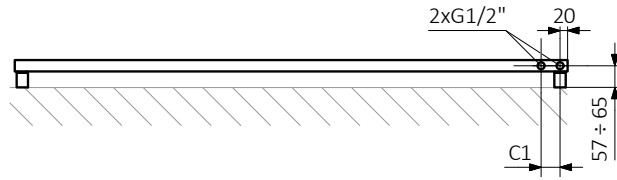

YL

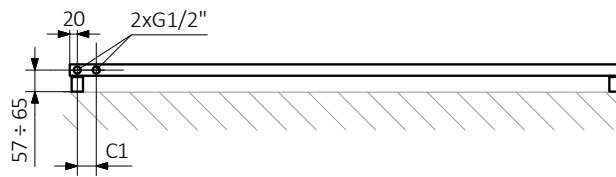

SX

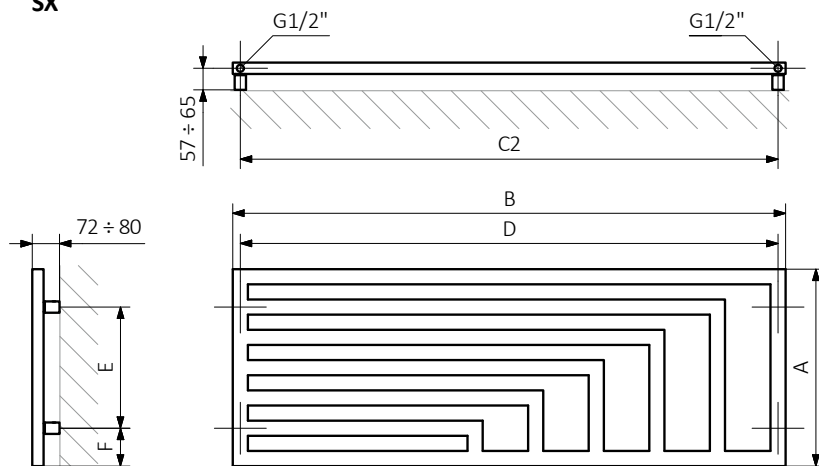

A - Höhe B - Breite C1-C5 - Anschlussabstand D - horizontaler Wandhalterungsabstand E - Vertikaler Wandhalterungsabstand F - Abstand von der Achse der unteren Wandhalterung bis Unterkante des Kollektors

Rohr:

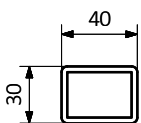

Y2

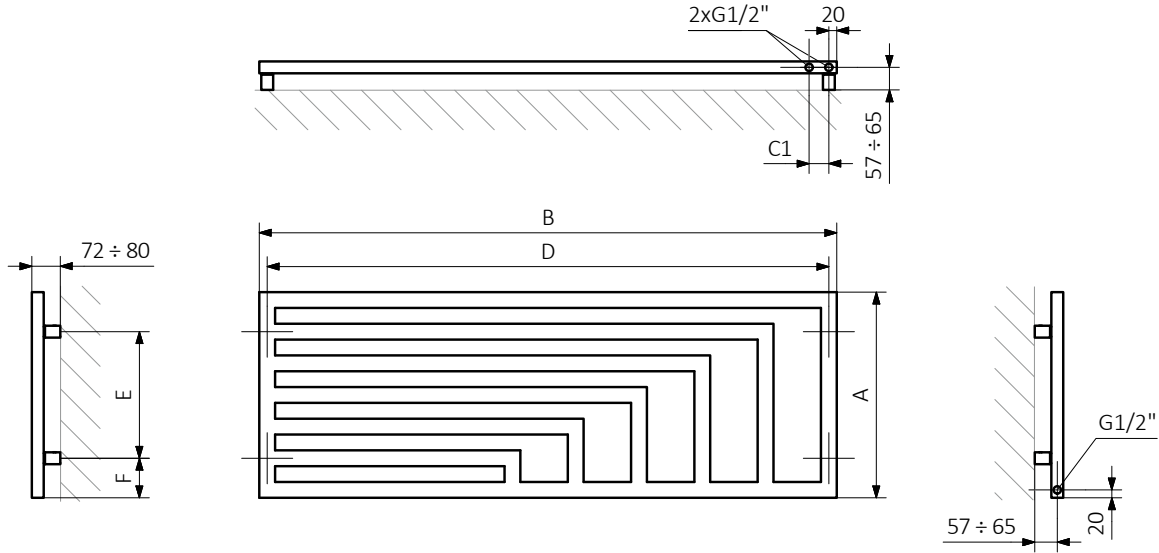

Y7

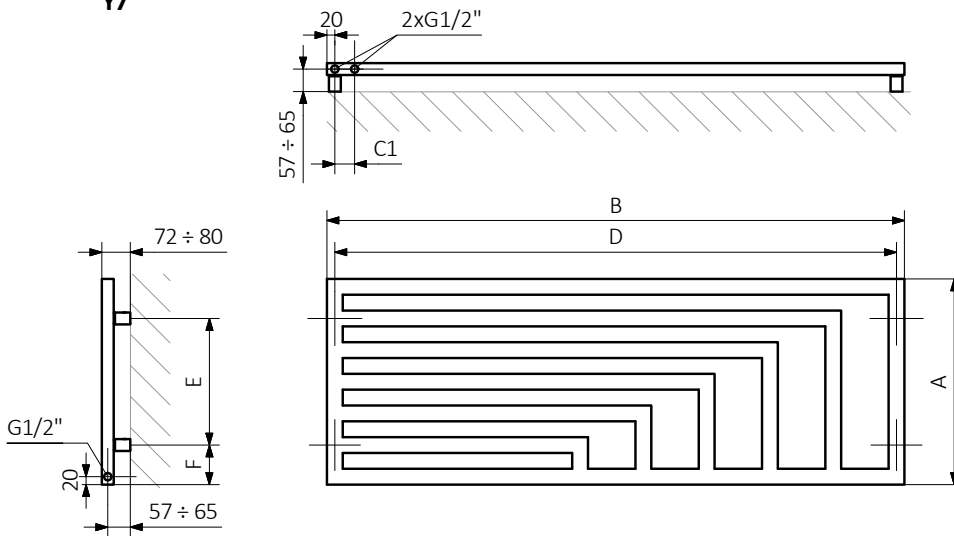

A – Höhe B – Breite C1-C5 – Anschlussabstand D – horizontaler Wandhalterungsabstand E – Vertikaler Wandhalterungsabstand
 F – Abstand von der Achse der unteren Wandhalterung bis Unterkante des Kollektors

Rohr:

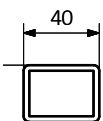

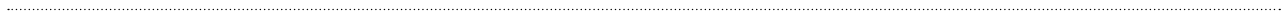



Standard Anschlussstypen:

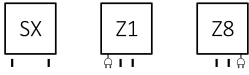

Elektroheizkörper siehe Seite 321

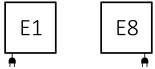

Weitere mögliche Anschlussstypen:

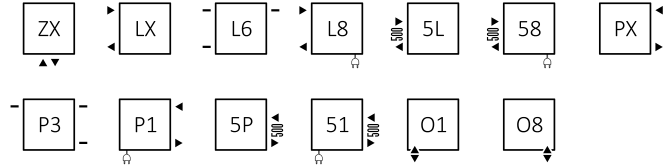

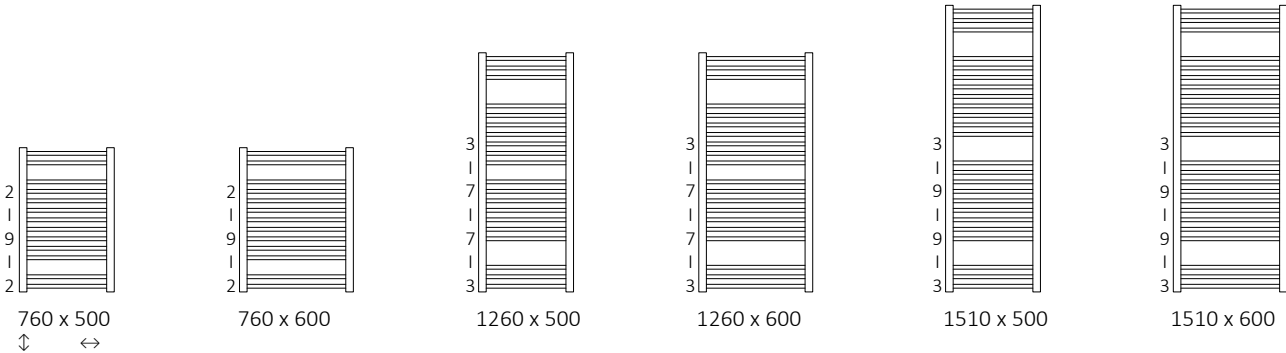

Verfügbare Größen:



Technische Daten:

Betriebsdruck: 800 kPa

Maximale Betriebstemperatur: 95°C

A ↓ [mm]	B ↔ [mm]	C1 [mm]	C2 [mm]	75/65/20°C [W]	55/45/20°C [W]	 [W]	D [mm]	E [mm]	F [mm]	 [dm ²]	 [kg]	Artikelnummer <small>(Konfigurations code s. 662)</small>
Pulverlack												
760	500	50	460	320	173	300	460	580	90	3,09	7,34	WGBON076050
760	600	50	560	384	208	400	560	580	90	3,46	8,47	WGBON076060
1260	500	50	460	503	271	600	460	1080	90	4,93	11,45	WGBON126050
1260	600	50	560	603	325	600	560	1080	90	5,51	13,19	WGBON126060
1510	500	50	460	607	323	600	460	1330	90	5,92	13,68	WGBON151050
1510	600	50	560	728	387	800	560	1330	90	6,61	15,78	WGBON151060
Galvanische Oberfläche												
760	500	50	460	224	121	200	460	580	90	3,09	7,09	WGBON076050
760	600	50	560	269	145	300	560	580	90	3,46	8,19	WGBON076060
1260	500	50	460	352	190	400	460	1080	90	4,93	11,06	WGBON126050
1260	600	50	560	422	227	400	560	1080	90	5,51	12,75	WGBON126060
1510	500	50	460	425	226	400	460	1330	90	5,92	13,22	WGBON151050
1510	600	50	560	510	271	600	560	1330	90	6,61	15,24	WGBON151060

Wir empfehlen: Set Winkeck-Thermostatventil mit T-Stück für Anschluss SX.



Set einteilige Blende



Heizpatrone ONE



Handtuchhalter ZIP H 20



SX

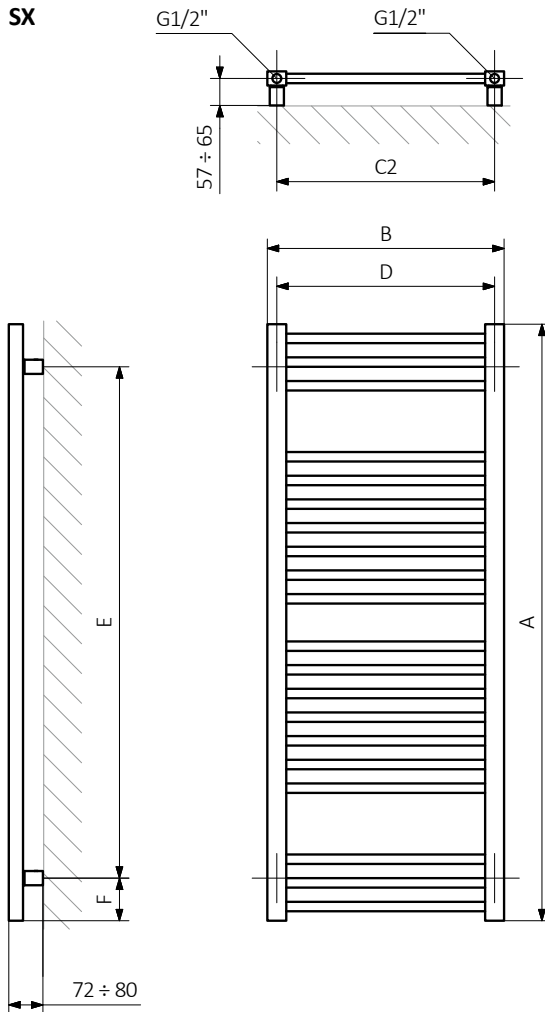

Z1

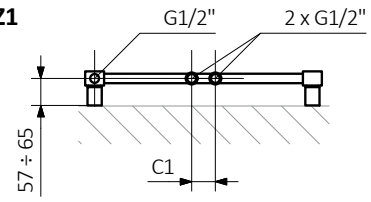

Z8

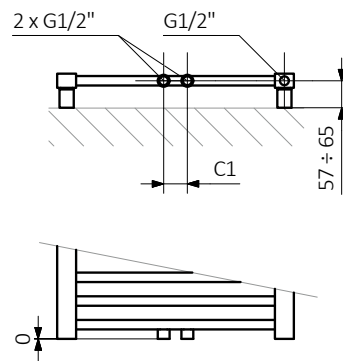

E1

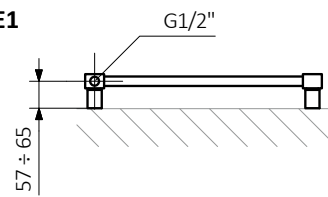

E8

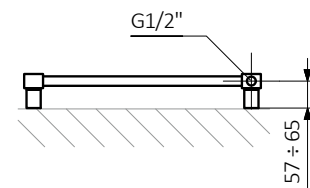

A - Höhe B - Breite C1-C5 - Anschlussabstand D - horizontaler Wandhalterungsabstand E - Vertikaler Wandhalterungsabstand F - Abstand von der Achse der unteren Wandhalterung bis Unterkante des Kollektors

Kollektor:

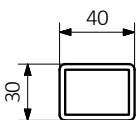

Rohr:

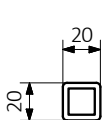



Standard Anschlussstypen:

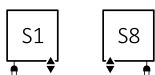

Elektroheizkörper siehe Seite 321

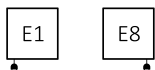

Weitere mögliche Anschlussstypen:

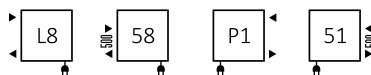

Verfügbare Größen:

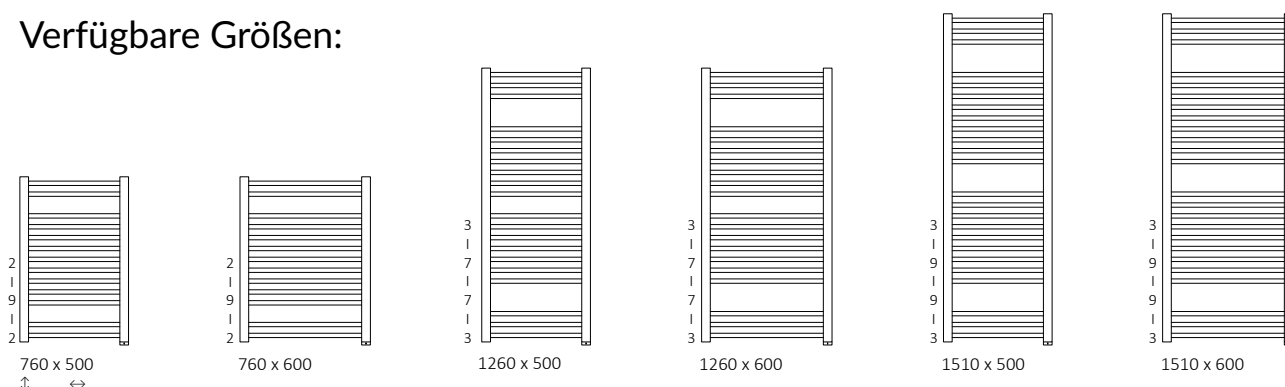

Technische Daten:

Betriebsdruck: 800 kPa Maximale Betriebstemperatur: 82°C

A ↓ [mm]	B ↔ [mm]	75/65/20°C [W]	55/45/20°C [W]	[W]	D [mm]	E [mm]	F [mm]	[dm³]	[kg]	Artikelnummer <small>(Konfigurationscode s. 663)</small>
Pulverlack										
760	500	320	173	300	460	620	70	2,99	7,34	WZBNN076050
760	600	384	208	400	560	620	70	3,37	8,47	WZBNN076060
1260	500	503	271	600	460	1120	70	4,84	11,45	WZBNN126050
1260	600	603	325	600	560	1120	70	5,41	13,19	WZBNN126060
1510	500	607	323	600	460	1370	70	5,82	13,68	WZBNN151050
1510	600	728	387	800	560	1370	70	6,51	15,78	WZBNN151060
Galvanische Oberfläche										
760	500	224	121	200	460	620	70	2,99	7,09	WZBNN076050
760	600	269	145	300	560	620	70	3,37	8,19	WZBNN076060
1260	500	352	190	400	460	1120	70	4,84	11,06	WZBNN126050
1260	600	422	227	400	560	1120	70	5,41	12,75	WZBNN126060
1510	500	425	226	400	460	1370	70	5,82	13,22	WZBNN151050
1510	600	510	271	600	560	1370	70	6,51	15,24	WZBNN151060

Wir empfehlen: Set Lanzen-Thermostat-Verbund-eckventil für Anschluss S1, S8

Abdeckblende

Handtuchhalter
ZIP H 20

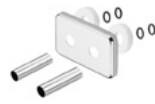

S8

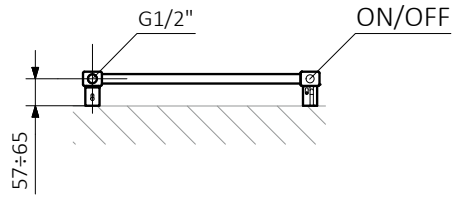

S1

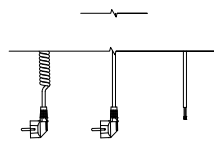
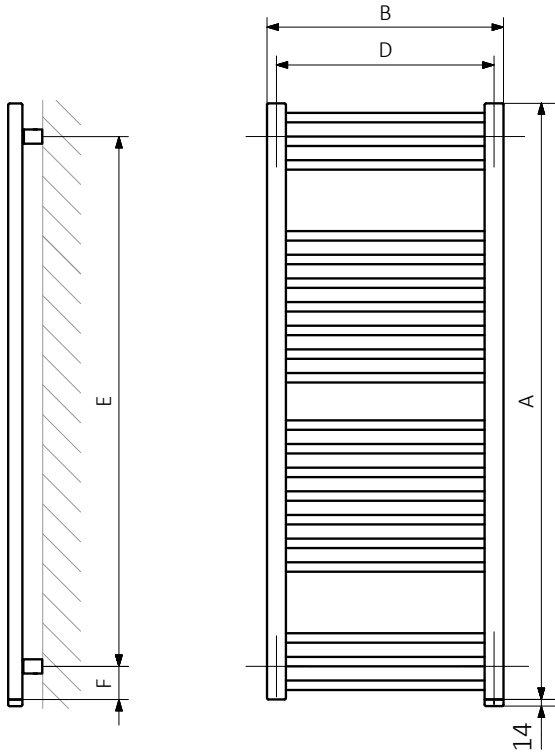
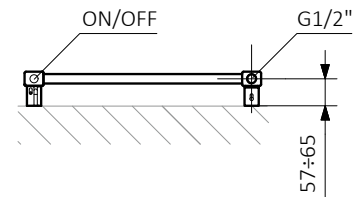

A - Höhe B - Breite C1-C5 - Anschlussabstand D - horizontaler Wandhalterungsabstand E - Vertikaler Wandhalterungsabstand F - Abstand von der Achse der unteren Wandhalterung bis Unterkante des Kollektors

Kollektor:

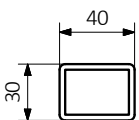

Rohr:

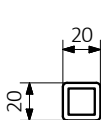



Standard Anschlussstypen:

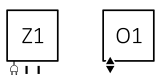

Elektroheizkörper siehe Seite 321



Weitere mögliche Anschlussstypen:



Verfügbare Größen:

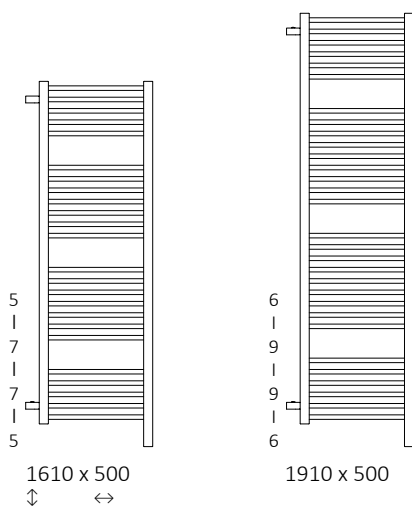

Technische Daten:

Betriebsdruck: 800 kPa

Maximale Betriebstemperatur: 95°C

A ↓ [mm]	B ↔ [mm]	C1 [mm]	75/65/20°C [W]	55/45/20°C [W]	[W]	E [mm]	F [mm]	[dm³]	[kg]	Artikelnummer <small>(Konfigurations code s. 662)</small>
1610	500	50	607	323	600	1350	80	5,92	13,68	WGBSD161050
1910	500	50	764	404	800	1650	80	7,24	16,80	WGBSD191050

Wir empfehlen: Set Thermostat Verbund-Durchgangsventil für Anschluss Z1



Abdeckblende



Heizpatronen Steuerung KTX 4



Handtuchhalter ZIP H 20

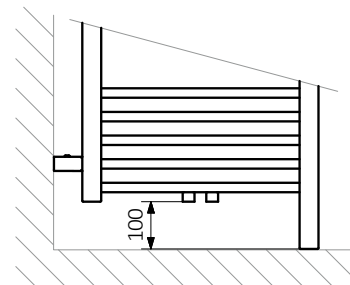
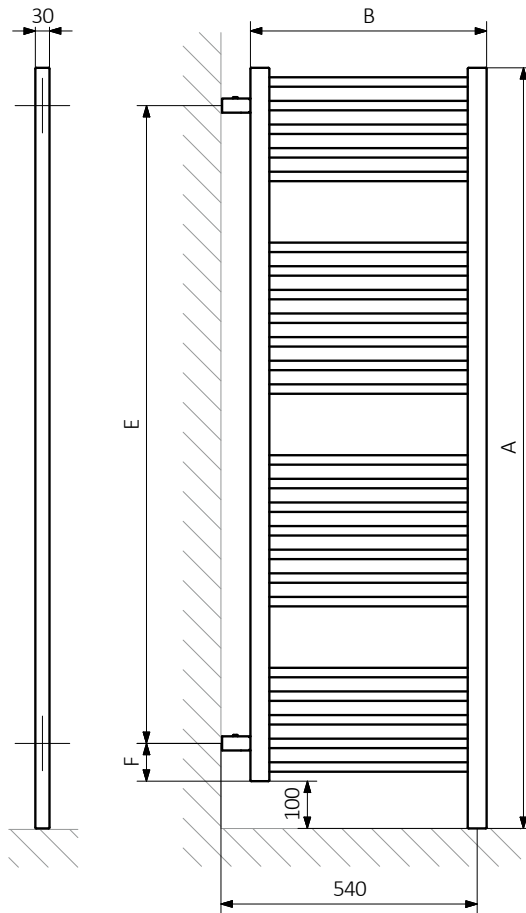
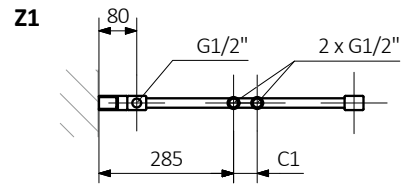
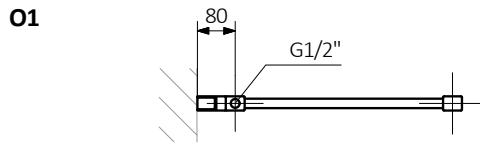

A - Höhe B - Breite C1-C5 - Anschlussabstand D - horizontaler Wandhalterungsabstand E - Vertikaler Wandhalterungsabstand F - Abstand von der Achse der unteren Wandhalterung bis Unterkante des Kollektors

Kollektor:

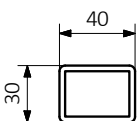

Rohr:

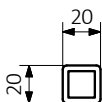



Standard Anschlussstypen:

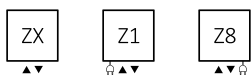

Weitere mögliche Anschlussstypen:

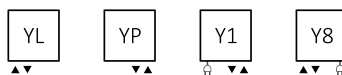

Verfügbare Größen:

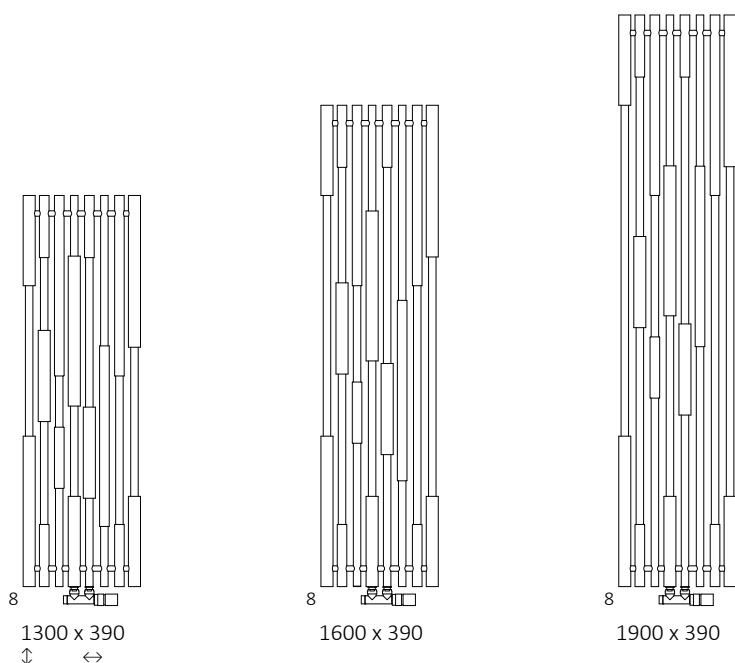

Technische Daten:

Betriebsdruck: 1000 kPa

Maximale Betriebstemperatur: 95°C

A ↓ [mm]	B ↔ [mm]	C1 [mm]	75/65 20°C [W]	55/45 20°C [W]	 [W]	D [mm]	E [mm]	F [mm]	 [dm³]	 [kg]	Artikelnummer <small>(Konfigurations code s. 662)</small>
1300	390	50	569	300	600	250	1180	60	6,77	13,53	WGCAN130039
1600	390	50	670	354	800	250	1480	60	7,69	15,30	WGCAN160039
1900	390	50	768	405	800	250	1780	60	8,56	17,78	WGCAN190039

Enthält: Wasser-Heizkörper wird zusammen mit Thermostat-Verbunddeckventil, Thermostatkopf Slim und Adapter zur Installation (ALU-PEX Ø 16x2 i Kupfer Ø 15) geliefert. Alle Elemente dieser Armatur sind komplett verchromt.

Wir empfehlen: Heizpatrone
REG 2



ZX

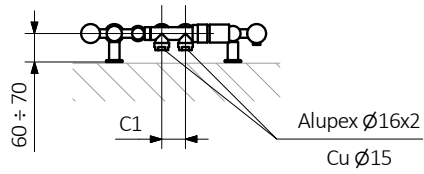

Z1

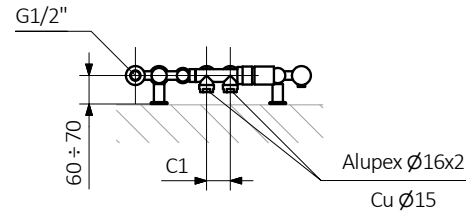

Z8

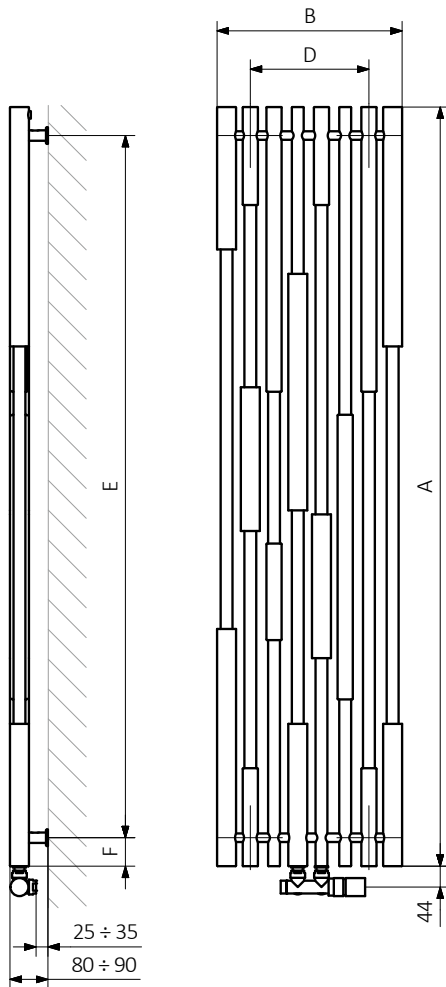
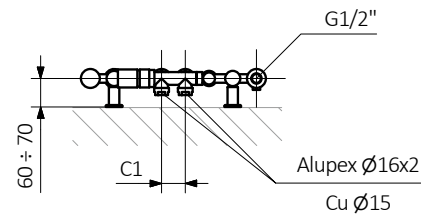

A - Höhe B - Breite C1-C5 - Anschlussabstand D - horizontaler Wandhalterungsabstand E - Vertikaler Wandhalterungsabstand F - Abstand von der Achse der unteren Wandhalterung bis Unterkante des Kollektors

Kollektor:

Rohr:

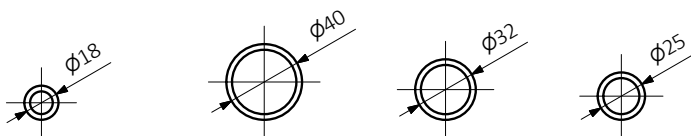



Standard Anschlussstypen:

A ↑ 585:

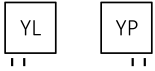

A ↑ 585÷1810:



Elektroheizkörper siehe Seite 321

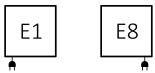

Weitere mögliche Anschlussstypen:

A ↑ 585÷1810:



Handtuchhalter Case Slim.

Beim Kauf eines Heizkörpers Case Slim kostet der erste Handtuchhalter nur 1 EUR. Für jeden weiteren Halter gilt der Preis in unserer Preisliste. Das Angebot betrifft die Breiten des Heizkörpers 420 mm, 520 mm und 620 mm.



Verfügbare Größen:

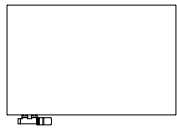

585 x 900

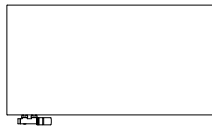

585 x 1100



585 x 1300



1360 x 420
↓ ↔



1360 x 520

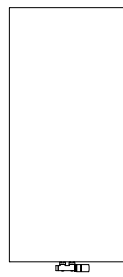

1360 x 620

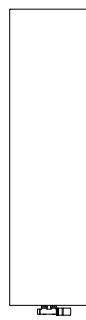

1585 x 420

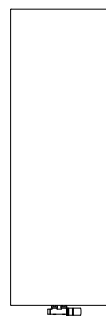

1585 x 520

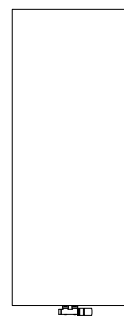

1585 x 620

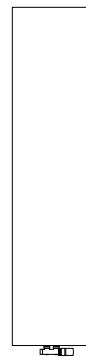

1810 x 420



1810 x 520

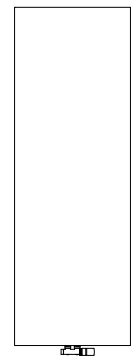

1810 x 620

Wir empfehlen: Abdeckblende





Heizpatrone
ONE





Technische Daten:

Betriebsdruck: 800 kPa

Maximale Betriebstemperatur: 95°C

A ↓	B ↔	C1 [mm]	75/65/20°C [W]	55/45/20°C [W]	 [W]	D [mm]	E [mm]	F [mm]	 [dm ³]	 [kg]	Artikelnummer <small>(Konfigurationscode s. 662)</small>
Metall											
585	900	50	438	229	400	650	415	30	3,93	25,98	WGCSS058090
585	1100	50	536	281	600	850	415	30	4,69	32,76	WGCSS058110
585	1300	50	634	332	600	1050	415	30	5,44	38,41	WGCSS058130
1360	420	50	422	219	400	170	1190	30	5,26	30,12	WGCSS136042
1360	520	50	523	271	600	270	1190	30	6,23	36,67	WGCSS136052
1360	620	50	624	324	600	370	1190	30	7,19	43,21	WGCSS136062
1585	420	50	470	243	400	170	1415	30	6,18	34,92	WGCSS158042
1585	520	50	580	300	600	270	1415	30	7,31	42,56	WGCSS158052
1585	620	50	693	358	800	370	1415	30	8,45	50,19	WGCSS158062
1810	420	50	516	266	600	170	1640	30	7,09	39,73	WGCSS181042
1810	520	50	639	330	600	270	1640	30	8,40	48,44	WGCSS181052
1810	620	50	762	393	800	370	1640	30	9,70	57,16	WGCSS181062
Glas											
585	900	50	438	229	400	650	415	30	3,93	32,59	WGCSG058090
585	1100	50	536	281	600	850	415	30	4,69	39,37	WGCSG058110
585	1300	50	634	332	600	1050	415	30	5,44	46,16	WGCSG058130
1360	420	50	422	219	400	170	1190	30	5,26	37,23	WGCSG136042
1360	520	50	523	271	600	270	1190	30	6,23	45,49	WGCSG136052
1360	620	50	624	324	600	370	1190	30	7,19	53,81	WGCSG136062
1585	420	50	470	243	400	170	1415	30	6,18	43,29	WGCSG158042
1585	520	50	580	300	600	270	1415	30	7,31	52,91	WGCSG158052
1585	620	50	693	358	800	370	1415	30	8,45	62,52	WGCSG158062
1810	420	50	516	266	600	170	1640	30	7,09	49,27	WGCSG181042
1810	520	50	639	330	600	270	1640	30	8,40	60,25	WGCSG181052
1810	620	50	762	393	800	370	1640	30	9,70	71,23	WGCSG181062
Spiegel											
585	900	50	438	229	400	650	415	30	3,93	32,59	WGCSM058090
585	1100	50	536	281	600	850	415	30	4,69	39,37	WGCSM058110
585	1300	50	634	332	600	1050	415	30	5,44	46,16	WGCSM058130
1360	420	50	422	219	400	170	1190	30	5,26	37,23	WGCSM136042
1360	520	50	523	271	600	270	1190	30	6,23	45,49	WGCSM136052
1360	620	50	624	324	600	370	1190	30	7,19	53,81	WGCSM136062
1585	420	50	470	243	400	170	1415	30	6,18	43,29	WGCSM158042
1585	520	50	580	300	600	270	1415	30	7,31	52,91	WGCSM158052
1585	620	50	693	358	800	370	1415	30	8,45	62,52	WGCSM158062
1810	420	50	516	266	600	170	1640	30	7,09	49,27	WGCSM181042
1810	520	50	639	330	600	270	1640	30	8,40	60,25	WGCSM181052
1810	620	50	762	393	800	370	1640	30	9,70	71,23	WGCSM181062

A ↓	B ↔	C1 [mm]	75/65/20°C [W]	55/45/20°C [W]	 [W]	D [mm]	E [mm]	F [mm]	 [dm³]	 [kg]	Artikelnummer <small>(Konfigurations code s. 662)</small>
Grafik											
585	900	50	438	229	400	650	415	30	3,93	32,59	WGCSPO58090
585	1100	50	536	281	600	850	415	30	4,69	39,37	WGCSPO58110
585	1300	50	634	332	600	1050	415	30	5,44	46,16	WGCSPO58130
1360	420	50	422	219	400	170	1190	30	5,26	37,23	WGCSPO136042
1360	520	50	523	271	600	270	1190	30	6,23	45,49	WGCSPO136052
1360	620	50	624	324	600	370	1190	30	7,19	53,81	WGCSPO136062
1585	420	50	470	243	400	170	1415	30	6,18	43,29	WGCSPO158042
1585	520	50	580	300	600	270	1415	30	7,31	52,91	WGCSPO158052
1585	620	50	693	358	800	370	1415	30	8,45	62,52	WGCSPO158062
1810	420	50	516	266	600	170	1640	30	7,09	49,27	WGCSPO181042
1810	520	50	639	330	600	270	1640	30	8,40	60,25	WGCSPO181052
1810	620	50	762	393	800	370	1640	30	9,70	71,23	WGCSPO181062
Beton											
585	900	50	438	229	400	650	415	30	3,93	27,98	WGCSB058090
585	1100	50	536	281	600	850	415	30	4,69	33,72	WGCSB058110
585	1300	50	634	332	600	1050	415	30	5,44	39,46	WGCSB058130
1360	420	50	422	219	400	170	1190	30	5,26	32,21	WGCSB136042
1360	520	50	523	271	600	270	1190	30	6,23	39,22	WGCSB136052
1360	620	50	624	324	600	370	1190	30	7,19	46,29	WGCSB136062
1585	420	50	470	243	400	170	1415	30	6,18	37,42	WGCSB158042
1585	520	50	580	300	600	270	1415	30	7,31	45,58	WGCSB158052
1585	620	50	693	358	800	370	1415	30	8,45	53,73	WGCSB158062
1810	420	50	516	266	600	170	1640	30	7,09	42,56	WGCSB181042
1810	520	50	639	330	600	270	1640	30	8,40	51,87	WGCSB181052
1810	620	50	762	393	800	370	1640	30	9,70	61,17	WGCSB181062

Enthält: Bei Anschlüssen ZX, Z1 und Z8 wird der Heizkörper zusammen mit Thermostat-Verbunddeckventil, Thermostatkopf SLIM und Adapter zur Installation (ALU-PEX Ø 16x2 und Kupfer Ø 15) geliefert. Bei Anschluss SX kontaktieren Sie bitte den Vertriebspartner. Alle Elemente dieser Armatur sind komplett verchromt.

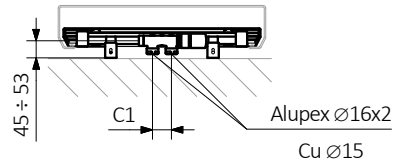
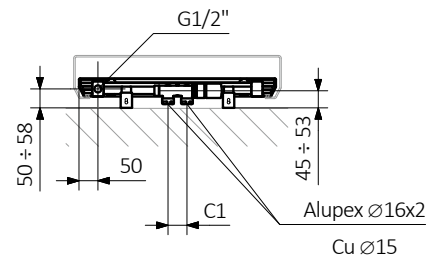
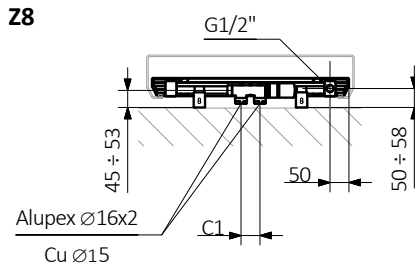
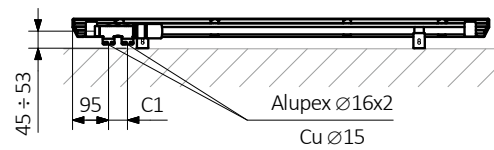
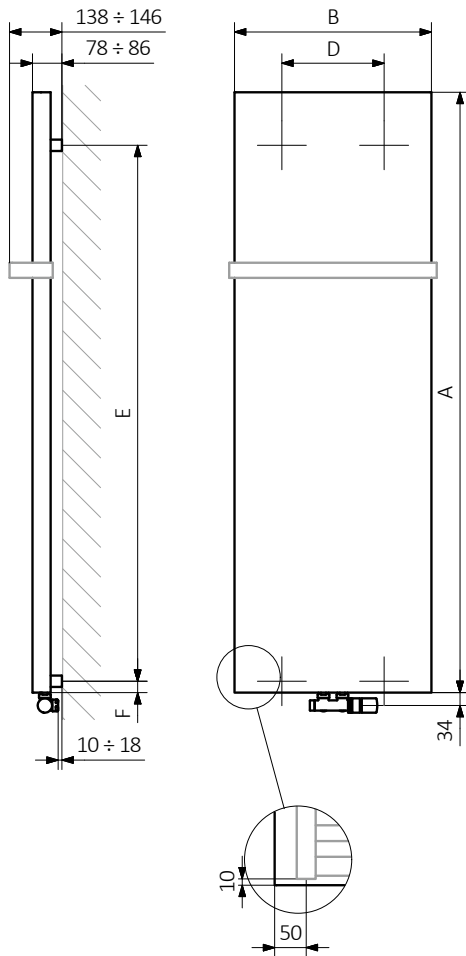
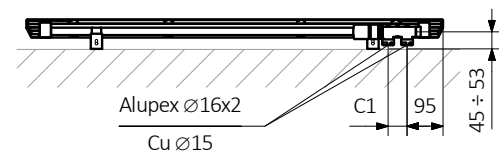
ZX**Z1****Z8****YL****YP**

A - Höhe B - Breite C1-C5 - Anschlussabstand D - horizontaler Wandhalterungsabstand E - Vertikaler Wandhalterungsabstand F - Abstand von der Achse der unteren Wandhalterung bis Unterkante des Kollektors

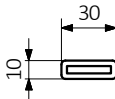
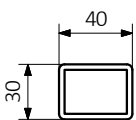
Kollektor:**Rohr:**



Standard Anschlussstypen:

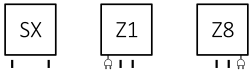

Elektroheizkörper siehe Seite 321

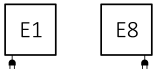

Weitere mögliche Anschlussstypen:

A ↓ 510÷1860:

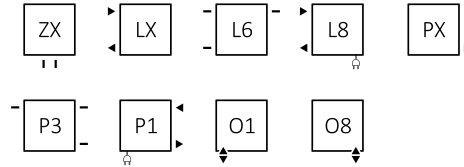

A ↓ 780-1860:

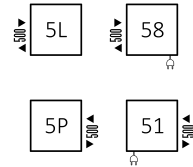

Verfügbare Größen:

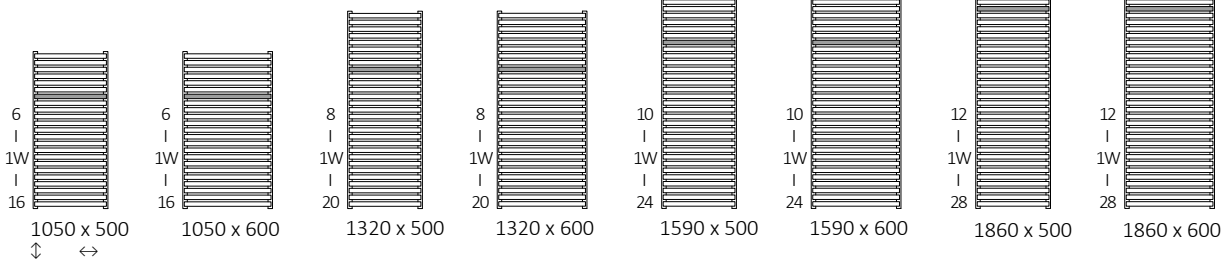
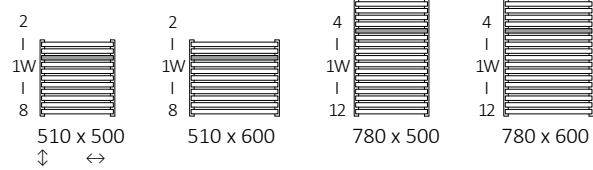

Technische Daten:

Betriebsdruck: 1000 kPa

Maximale Betriebstemperatur: 95°C

A ↓ [mm]	B ↔ [mm]	C1 [mm]	C2 [mm]	75/65/20°C [W]	55/45/20°C [W]	[W]	D [mm]	E [mm]	F [mm]	[dm³]	[kg]	Artikelnummer <small>(Konfigurations code s. 662)</small>
510	500	50	470	304	164	300	470	330	90	1,82	6,59	WGCIT051050
510	600	50	570	362	195	400	570	330	90	2,03	7,57	WGCIT051060
780	500	50	470	455	245	400	470	600	90	2,81	10,12	WGCIT078050
780	600	50	570	541	291	600	570	600	90	3,13	11,63	WGCIT078060
1050	500	50	470	600	323	600	470	870	90	3,79	13,64	WGCIT105050
1050	600	50	570	714	384	800	570	870	90	4,23	15,69	WGCIT105060
1320	500	50	470	739	397	800	470	1140	90	4,78	17,17	WGCIT132050
1320	600	50	570	879	473	800	570	1140	90	5,32	19,76	WGCIT132060
1590	500	50	470	887	476	800	470	1410	90	5,66	20,26	WGCIT159050
1590	600	50	570	1055	566	1000	570	1410	90	6,30	23,30	WGCIT159060
1860	500	50	470	1032	553	1000	470	1680	90	6,74	24,29	WGCIT186050
1860	600	50	570	1227	657	1200	570	1680	90	7,52	27,95	WGCIT186060

Wir empfehlen: Set Thermostat Verbunddeckventil für Anschluss YL, YP, Y1 und Y8



Abdeckblende



Heizpatronen Steuerung KTX 4

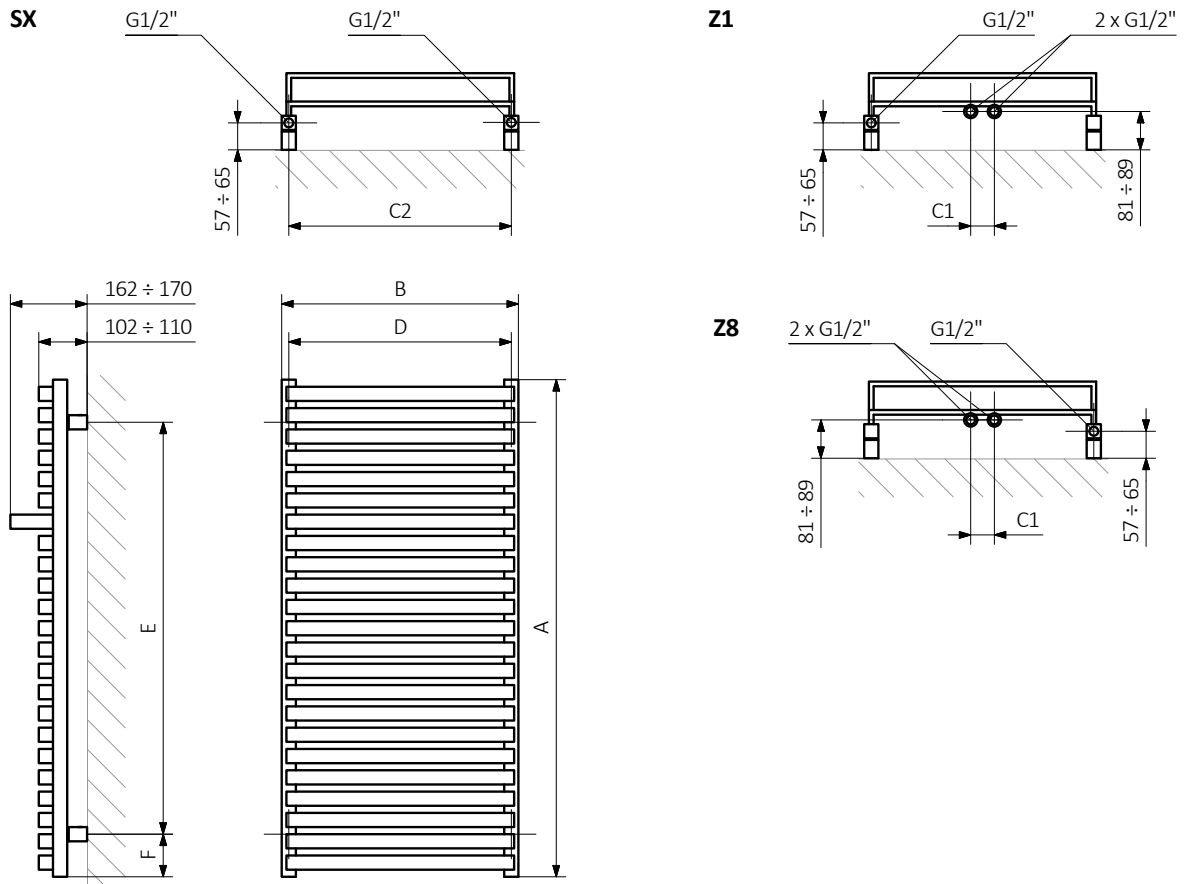

A - Höhe B - Breite C1-C5 - Anschlussabstand D - horizontaler Wandhalterungsabstand E - Vertikaler Wandhalterungsabstand F - Abstand von der Achse der unteren Wandhalterung bis Unterkante des Kollektors

Kollektor:

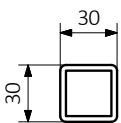

Rohr:

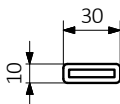



Standard Anschlussstypen:

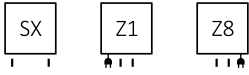

Elektroheizkörper siehe Seite 321

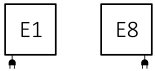

Weitere mögliche Anschlussstypen:

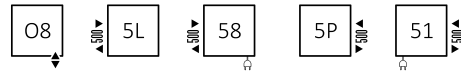
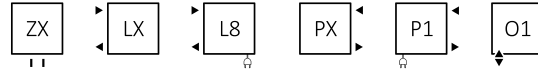

Verfügbare Größen:

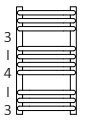

540 x 300
⇕ ⇔

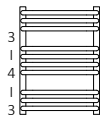

540 x 400

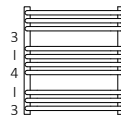

540 x 500

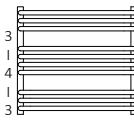

540 x 600

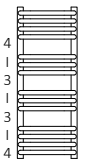

760 x 300
⇕ ⇔

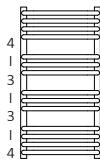

760 x 400



760 x 500

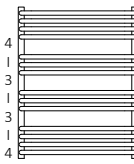

760 x 600

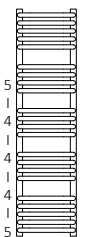

1140 x 300
⇕ ⇔



1140 x 400



1140 x 500

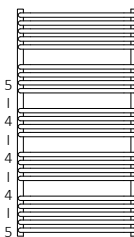

1140 x 600

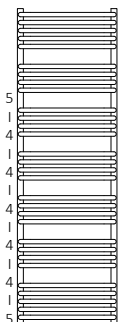

1580 x 500
⇕ ⇔



1580 x 600

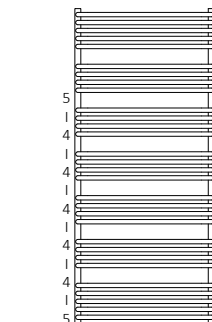

1580 x 700

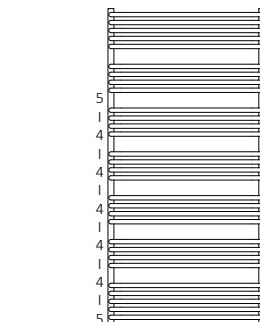

1580 x 800

Wir empfehlen: Set Winkeleck-Thermostat-ventil für Anschluss SX



Set einteilige Blende



Heizpatrone MOA



Handtuchhalter Yo!



Technische Daten:

Betriebsdruck: 1000 kPa

Maximale Betriebstemperatur: 95°C

A ↓ [mm]	B ↔ [mm]	C1 [mm]	C2 [mm]	75/65/20°C [W]	55/45/20°C [W]	Ⓢ [W]	D [mm]	E [mm]	F [mm]	H [dm³]	⚖️ [kg]	Artikelnummer <small>(Konfigurations code s. 662)</small>
Pulverlack												
540	300	50	270	180	99	200	270	360	90	1,75	3,71	WGALE054030
540	400	50	370	238	129	200	370	360	90	2,04	4,38	WGALE054040
540	500	50	470	299	161	300	470	360	90	2,32	5,04	WGALE054050
540	600	50	570	355	190	400	570	360	90	2,60	5,71	WGALE054060
760	300	50	270	257	138	300	270	580	90	2,46	5,15	WGALE076030
760	400	50	370	330	177	300	370	580	90	2,85	6,08	WGALE076040
760	500	50	470	412	220	400	470	580	90	3,25	7,02	WGALE076050
760	600	50	570	481	257	600	570	580	90	3,65	7,95	WGALE076060
1140	300	50	270	362	194	400	270	960	90	3,78	7,86	WGALE114030
1140	400	50	370	479	257	400	370	960	90	4,41	9,33	WGALE114040
1140	500	50	470	591	313	600	470	960	90	5,03	10,8	WGALE114050
1140	600	50	570	711	380	800	570	960	90	5,65	12,27	WGALE114060
1580	500	50	470	793	425	800	470	1400	90	6,90	14,74	WGALE158050
1580	600	50	570	949	508	1000	570	1400	90	7,75	16,75	WGALE158060
1580	700	50	670	1104	591	1000	670	1400	90	8,60	18,75	WGALE158070
1580	800	50	770	1253	670	1200	770	1400	90	9,45	20,76	WGALE158080
Galvanische Oberfläche												
540	300	50	270	126	64	120	270	360	90	1,75	3,57	WGALE054030
540	400	50	370	167	85	200	370	360	90	2,04	4,21	WGALE054040
540	500	50	470	209	107	200	470	360	90	2,32	4,85	WGALE054050
540	600	50	570	249	127	300	570	360	90	2,60	5,49	WGALE054060
760	300	50	270	180	92	200	270	580	90	2,46	4,95	WGALE076030
760	400	50	370	231	118	200	370	580	90	2,85	5,85	WGALE076040
760	500	50	470	288	147	300	470	580	90	3,25	6,74	WGALE076050
760	600	50	570	337	172	400	570	580	90	3,65	7,64	WGALE076060
1140	300	50	270	253	129	300	270	960	90	3,78	7,56	WGALE114030
1140	400	50	370	335	171	400	370	960	90	4,41	8,97	WGALE114040
1140	500	50	470	414	211	400	470	960	90	5,03	10,38	WGALE114050
1140	600	50	570	498	254	600	570	960	90	5,65	11,79	WGALE114060
1580	500	50	470	555	283	600	470	1400	90	6,90	14,17	WGALE158050
1580	600	50	570	664	339	600	570	1400	90	7,75	16,09	WGALE158060
1580	700	50	670	773	394	800	670	1400	90	8,60	18,01	WGALE158070

S8

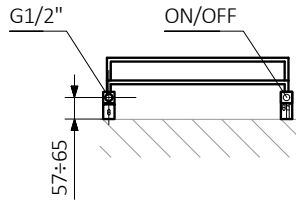

S1

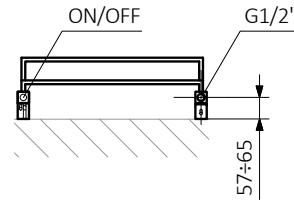

51

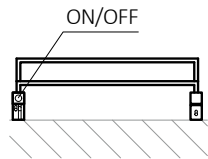

58

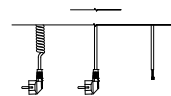
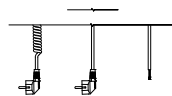
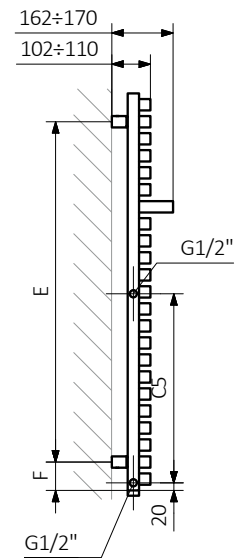
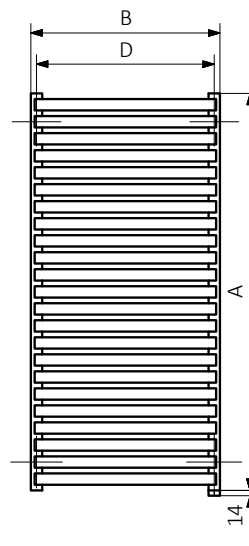
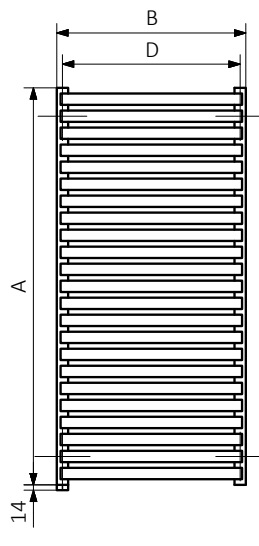
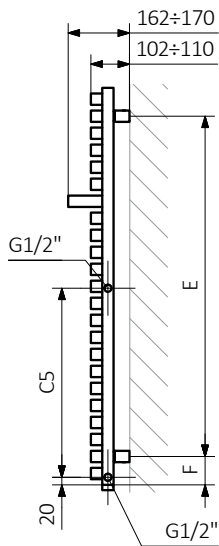
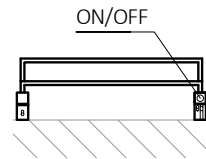

A – Höhe B – Breite C1-C5 – Anschlussabstand D – horizontaler Wandhalterungsabstand E – Vertikaler Wandhalterungsabstand
F – Abstand von der Achse der unteren Wandhalterung bis Unterkante des Kollektors

Kollektor:

Rohr:

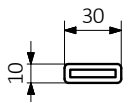
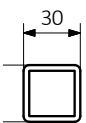

P1

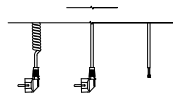
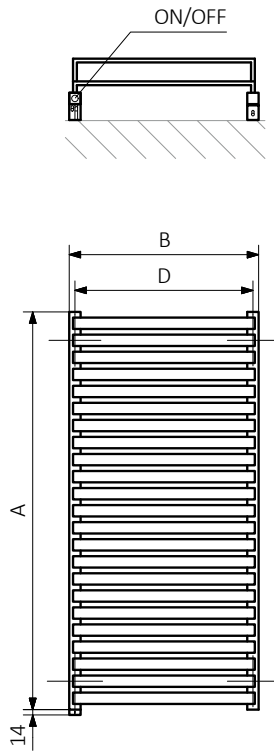
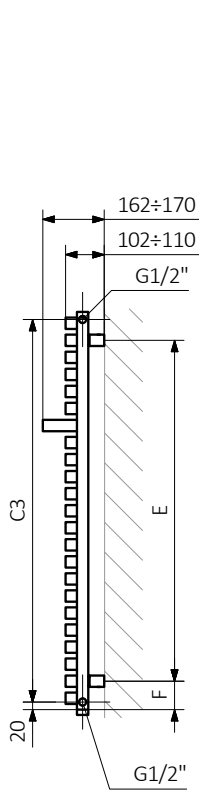

L8

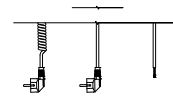
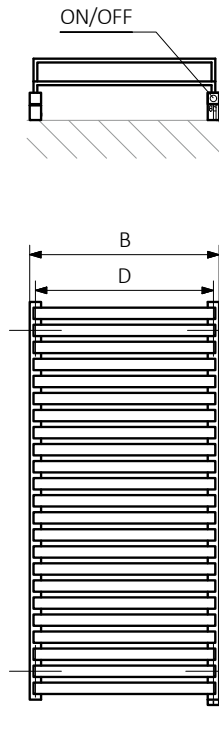
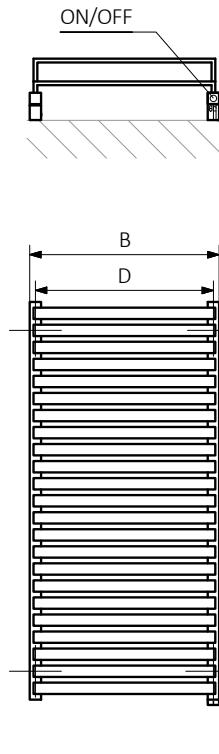



Standard Anschlussstypen:

A ↓ 440÷2000:

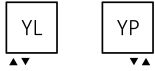

A ↓ 440÷640:

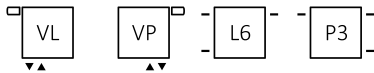

A ↓ 1800÷2000:

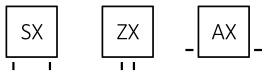

Weitere mögliche Anschlussstypen:

A ↓ 440÷2000:



A ↓ 440÷640:

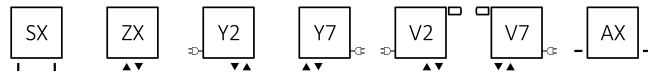

A ↓ 1800÷2000:

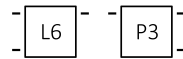

Elektroheizkörper siehe Seite 321. A ↓ 440÷640:

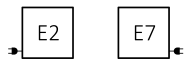

Technische Daten:

Betriebsdruck: 800 kPa

Maximale Betriebstemperatur: 95°C

A ↓ [mm]	B ↔ [mm]	C1 [mm]	C2 [mm]	C3 [mm]	C4 [mm]	75/65/20°C [W]	55/45/20°C [W]	☺ [W]	D [mm]	E [mm]	F [mm]	U [dm³]	⚖️ [kg]	Artikelnummer <small>(Konfigurations code s. 662)</small>
440	820	50	780	400	820	705	370	800	710	400	20	6,41	14,30	WGDLF044082
440	1020	50	980	400	1020	885	465	800	910	400	20	8,01	17,82	WGDLF044102
440	1220	50	1180	400	1220	1061	556	1000	1110	400	20	9,60	21,34	WGDLF044122
540	820	50	780	500	820	846	442	800	710	500	20	7,61	16,97	WGDLF054082
540	1020	50	980	500	1020	1057	553	1000	910	500	20	9,50	21,16	WGDLF054102
540	1220	50	1180	500	1220	1264	661	1200	1110	500	20	11,39	25,35	WGDLF054122
640	820	50	780	600	820	986	514	1000	710	600	20	8,80	19,65	WGDLF064082
640	1020	50	980	600	1020	1233	644	1200	910	600	20	10,99	24,50	WGDLF064102
640	1220	50	1180	600	1220	1458	760	1500	1110	600	20	13,19	29,36	WGDLF064122
1800	500	50	460	1760	500	1403	717	-	360	1760	20	13,61	30,48	WGDLF180050
1800	580	50	540	1760	580	1623	830	-	440	1760	20	15,87	35,52	WGDLF180058
2000	500	50	460	1960	500	1556	802	-	360	1960	20	15,04	33,68	WGDLF200050
2000	580	50	540	1960	580	1774	909	-	440	1960	20	17,55	39,26	WGDLF200058

Wir empfehlen: Set Absperr-Verbundventil
für Anschluss VL, VP



Abdeckblende



Verfügbare Größen:

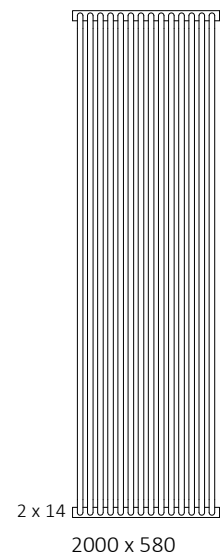
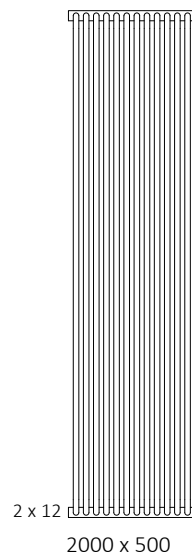
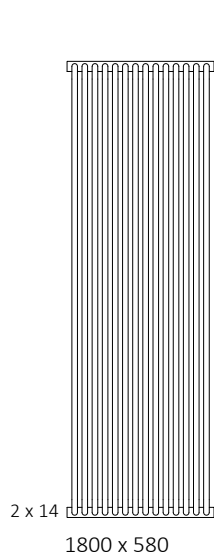
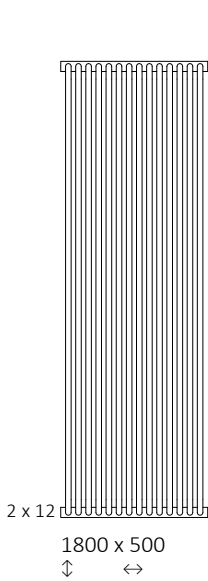
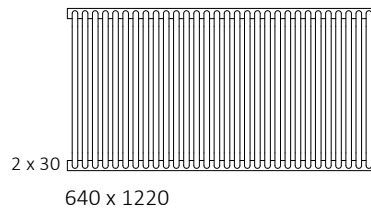
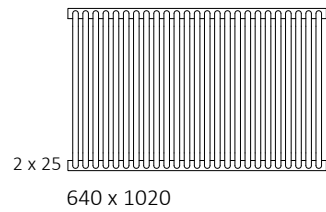
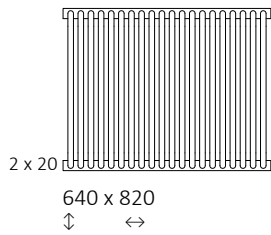
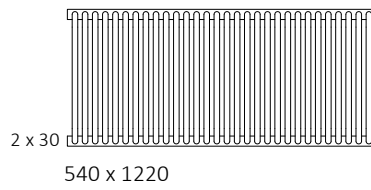
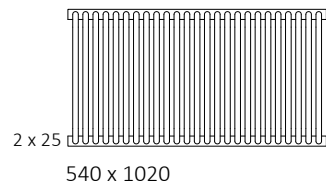
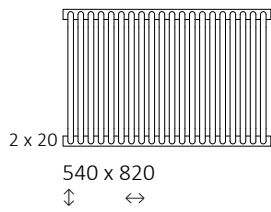
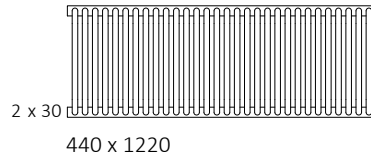
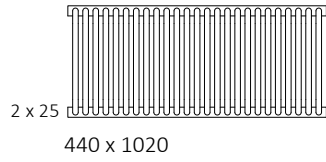
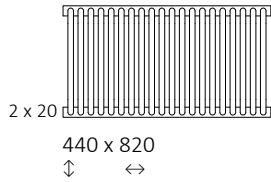

L6

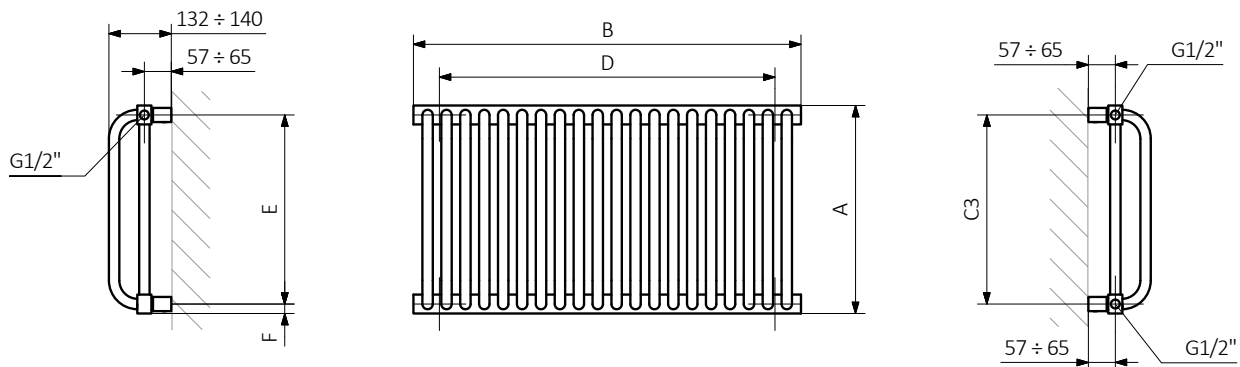

P3

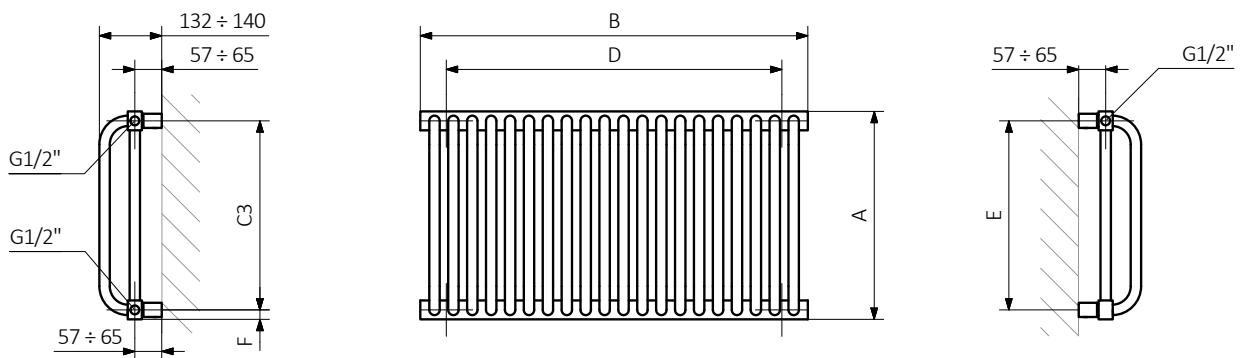

YL

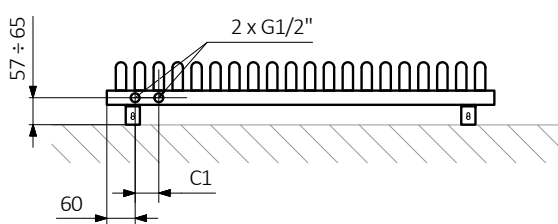

YP

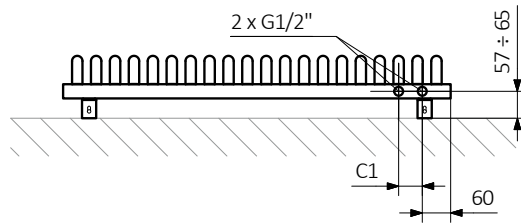

A – Höhe B – Breite C1-C5 – Anschlussabstand D – horizontaler Wandhalterungsabstand E – Vertikaler Wandhalterungsabstand F – Abstand von der Achse der unteren Wandhalterung bis Unterkante des Kollektors

Kollektor:

Rohr:

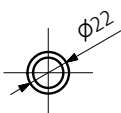
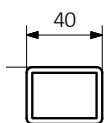

VL

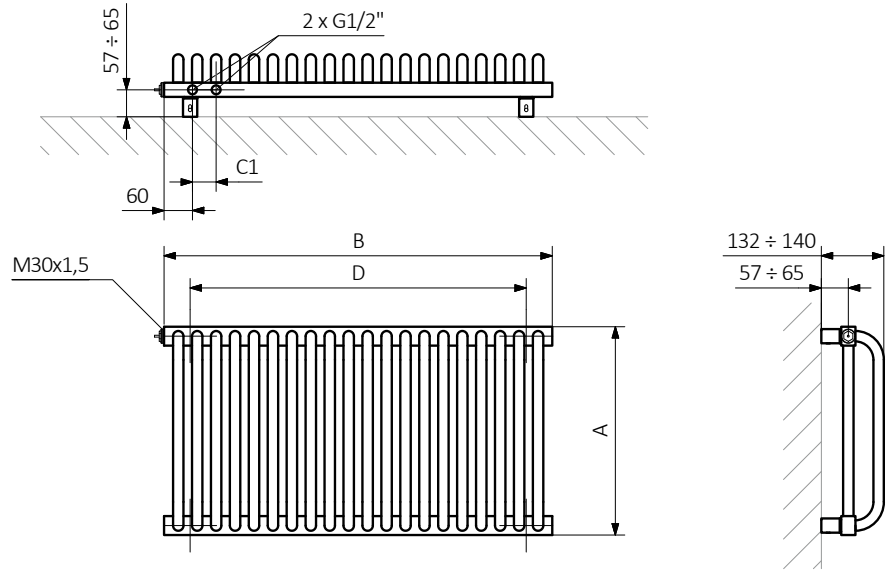

VP

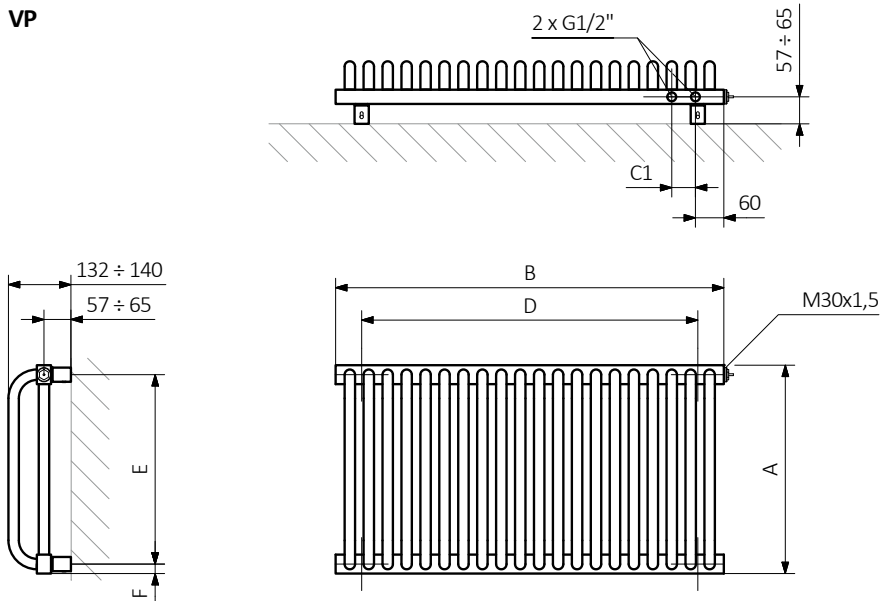

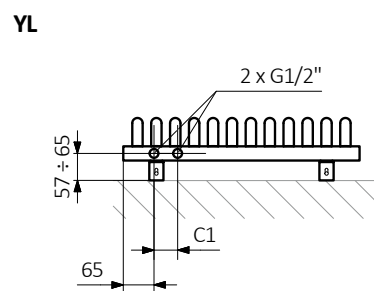
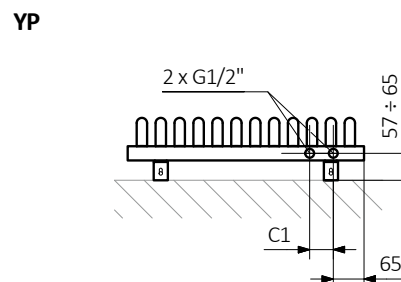
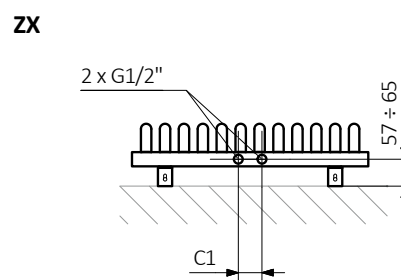
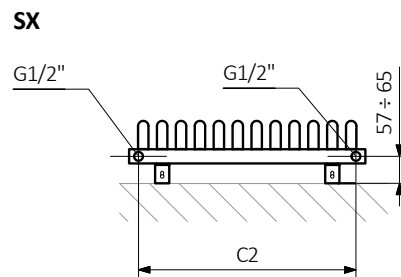
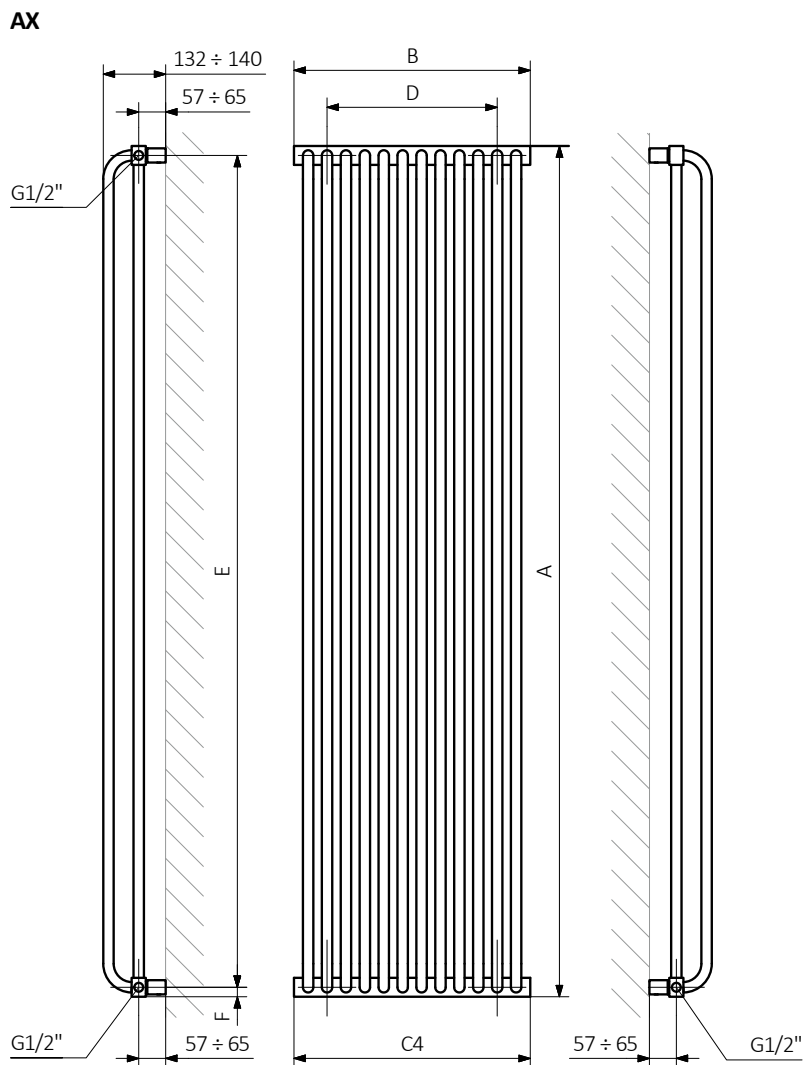

A - Höhe B - Breite C1-C5 - Anschlussabstand D - horizontaler Wandhalterungsabstand E - Vertikaler Wandhalterungsabstand F - Abstand von der Achse der unteren Wandhalterung bis Unterkante des Kollektors

Kollektor:

Rohr:

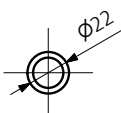
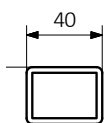

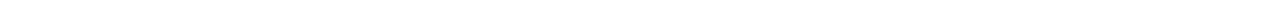



Standard Anschlussstypen:

Weitere mögliche Anschlussstypen:

Elektroheizkörper siehe Seite 321

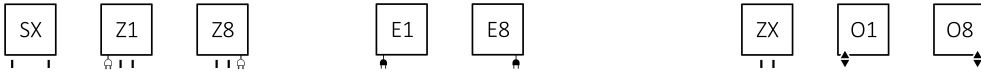

Verfügbare Größen:

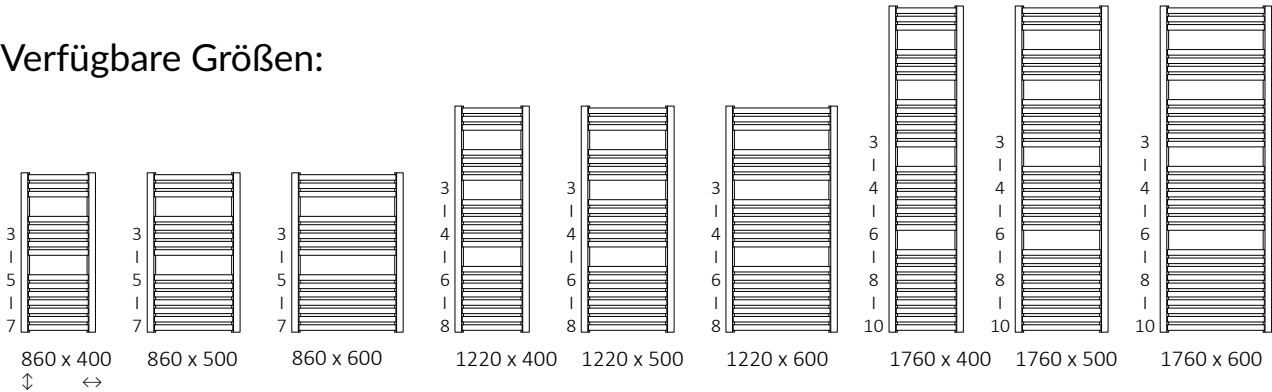

Technische Daten:

Betriebsdruck: 800 kPa

Maximale Betriebstemperatur: 95°C

A ↓ [mm]	B ↔ [mm]	C1 [mm]	C2 [mm]	75/65/20°C [W]	55/45/20°C [W]	 [W]	D [mm]	E [mm]	F [mm]	 [dm³]	 [kg]	Artikelnummer <small>(Konfigurations code s. 662)</small>
Pulverlack												
860	400	50	357	323	174	300	350	680	90	2,70	7,32	WGDEX086040
860	500	50	457	394	212	400	450	680	90	2,99	8,65	WGDEX086050
860	600	50	557	464	250	400	550	680	90	3,27	9,99	WGDEX086060
1220	400	50	357	440	237	400	350	1040	90	3,82	10,24	WGDEX122040
1220	500	50	457	541	291	600	450	1040	90	4,21	12,11	WGDEX122050
1220	600	50	557	640	344	600	550	1040	90	4,61	13,97	WGDEX122060
1760	400	50	357	618	332	600	350	1580	90	5,55	14,91	WGDEX176040
1760	500	50	457	762	409	800	450	1580	90	6,14	17,67	WGDEX176050
1760	600	50	557	906	487	1000	550	1580	90	6,72	20,42	WGDEX176060
Galvanische Oberfläche												
860	400	50	357	225	117	200	350	680	90	2,70	7,07	WGDEX086040
860	500	50	457	281	147	300	450	680	90	2,99	8,35	WGDEX086050
860	600	50	557	337	176	400	550	680	90	3,27	9,64	WGDEX086060
1220	400	50	357	298	155	300	350	1040	90	3,82	9,89	WGDEX122040
1220	500	50	457	373	194	400	450	1040	90	4,21	11,69	WGDEX122050
1220	600	50	557	448	233	400	550	1040	90	4,61	13,49	WGDEX122060
1760	400	50	357	421	218	400	350	1580	90	5,55	14,40	WGDEX176040
1760	500	50	457	526	273	600	450	1580	90	6,14	17,05	WGDEX176050
1760	600	50	557	631	327	600	550	1580	90	6,72	19,71	WGDEX176060

Wir empfehlen: Garnitur Thermostatventil DEXTER für Anschluss SX

Set einteilige Blende

Handtuchhalter ZIP H 10



SX

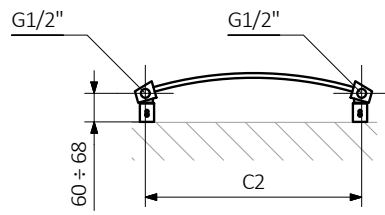

Z1

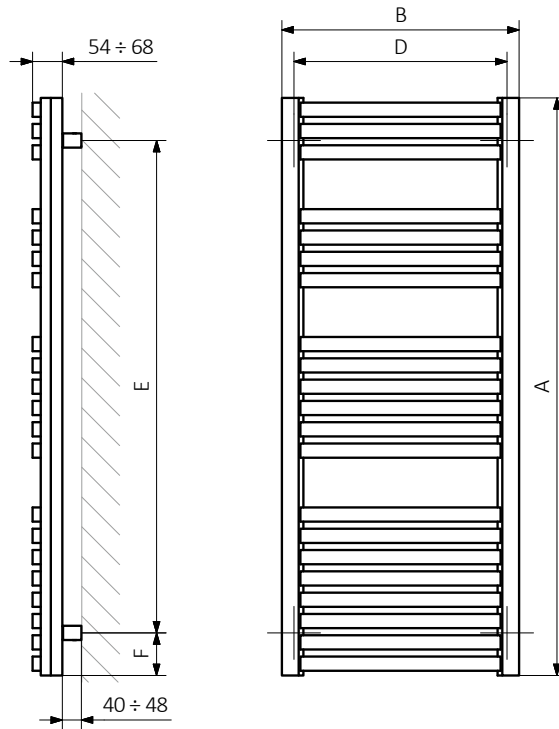
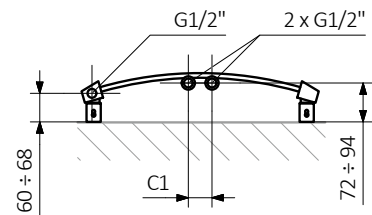

Z8

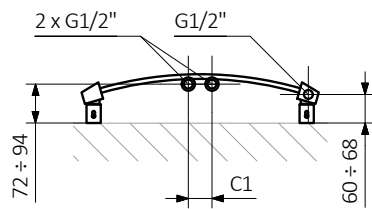

A - Höhe B - Breite C1-C5 - Anschlussabstand D - horizontaler Wandhalterungsabstand E - Vertikaler Wandhalterungsabstand F - Abstand von der Achse der unteren Wandhalterung bis Unterkante des Kollektors

Kollektor:

Rohr:

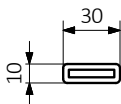
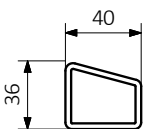



Standard Anschlussstypen:

Elektroheizkörper siehe Seite 321



Verfügbare Größen:

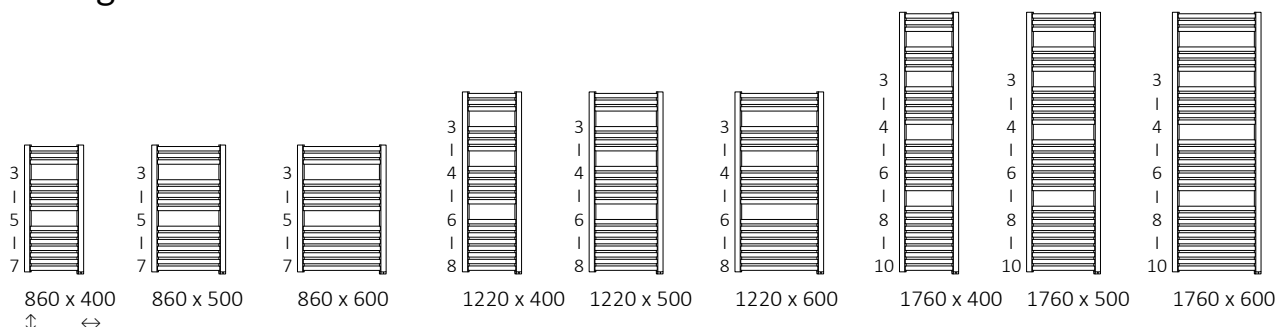

Technische Daten:

Betriebsdruck: 800 kPa Maximale Betriebstemperatur: 82°C

A ↓ [mm]	B ↔ [mm]	75/65/20°C [W]	55/45/20°C [W]	[W]	D [mm]	E [mm]	F [mm]	[dm³]	[kg]	Artikelnummer <small>(Konfigurations code s. 663)</small>
Pulverlack										
860	400	323	174	300	350	720	70	2,61	7,32	WZDEN086040
860	500	394	212	400	450	720	70	2,90	8,65	WZDEN086050
860	600	464	250	400	550	720	70	3,18	9,99	WZDEN086060
1220	400	440	237	400	350	1080	70	3,73	10,24	WZDEN122040
1220	500	541	291	600	450	1080	70	4,12	12,11	WZDEN122050
1220	600	640	344	600	550	1080	70	4,52	13,97	WZDEN122060
1760	400	618	332	600	350	1620	70	5,46	14,91	WZDEN176040
1760	500	762	409	800	450	1620	70	6,05	17,67	WZDEN176050
1760	600	906	487	1000	550	1620	70	6,63	20,42	WZDEN176060
Galvanische Oberfläche										
860	400	225	117	200	350	720	70	2,61	7,07	WZDEN086040
860	500	281	147	300	450	720	70	2,90	8,35	WZDEN086050
860	600	337	176	400	550	720	70	3,18	9,64	WZDEN086060
1220	400	298	155	300	350	1080	70	3,73	9,89	WZDEN122040
1220	500	373	194	400	450	1080	70	4,12	11,69	WZDEN122050
1220	600	448	233	400	550	1080	70	4,52	13,49	WZDEN122060
1760	400	421	218	400	350	1620	70	5,46	14,40	WZDEN176040
1760	500	526	273	600	450	1620	70	6,05	17,05	WZDEN176050
1760	600	631	327	600	550	1620	70	6,63	19,71	WZDEN176060

Wir empfehlen: Set Lanzen-Thermostat-Verbunddeck-ventil für Anschluss S1 und S8

Abdeckblende

Handtuchhalter
ZIP H 10



S8

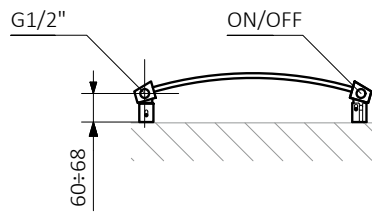

S1

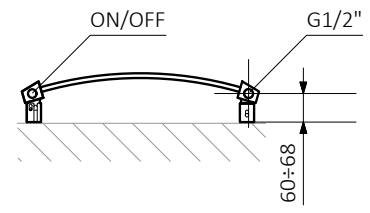

100÷108 (B=400)
107÷115 (B=600)
114÷122 (B=600)

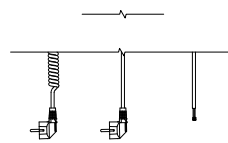
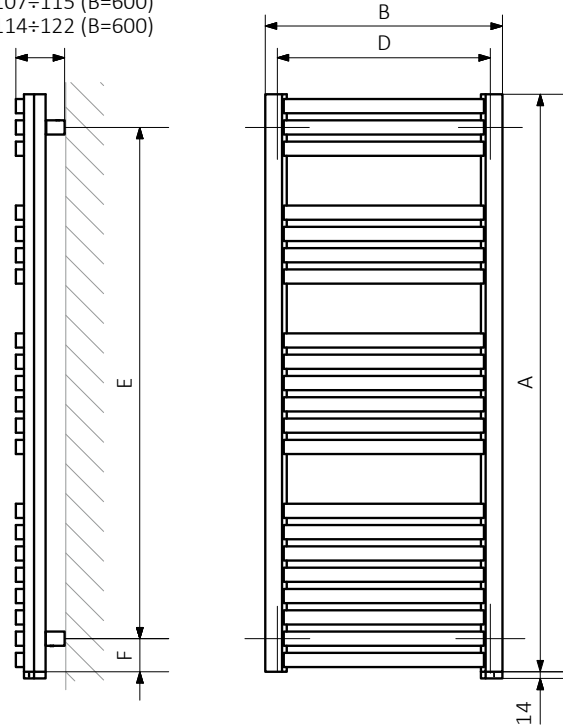

A - Höhe B - Breite C1-C5 - Anschlussabstand D - horizontaler Wandhalterungsabstand E - Vertikaler Wandhalterungsabstand F - Abstand von der Achse der unteren Wandhalterung bis Unterkante des Kollektors

Kollektor:

Rohr:

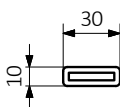
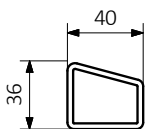



projekt: Darek Berus

Standard Anschlussstypen:

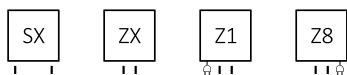

Elektroheizkörper siehe Seite 321

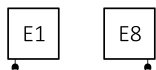

Weitere mögliche Anschlussstypen:

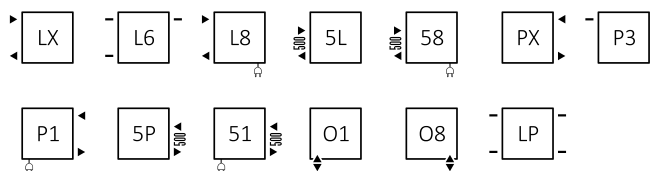

Technische Daten:

Betriebsdruck: 1000 kPa Maximale Betriebstemperatur: 95°C

A ↓ [mm]	B ↔ [mm]	C1 [mm]	C2 [mm]	75/65/20°C [W]	55/45/20°C [W]	☉ [W]	D [mm]	E [mm]	F [mm]	⏶ [dm³]	⚖️ [kg]	Artikelnummer <small>(Konfigurations code s. 662)</small>
Pulverlack												
880	400	50	360	270	146	300	360	720	80	2,58	5,5	WGDIM088040
880	500	50	460	320	174	300	460	720	80	2,97	6,4	WGDIM088050
880	600	50	560	367	199	400	560	720	80	3,36	7,3	WGDIM088060
1120	400	50	360	340	184	300	360	960	80	3,26	6,9	WGDIM112040
1120	500	50	460	400	217	400	460	960	80	3,74	8,0	WGDIM112050
1120	600	50	560	461	249	400	560	960	80	4,22	9,1	WGDIM112060
1360	400	50	360	410	221	400	360	1200	80	3,93	8,3	WGDIM136040
1360	500	50	460	484	261	400	460	1200	80	4,51	9,6	WGDIM136050
1360	600	50	560	554	299	600	560	1200	80	5,09	10,9	WGDIM136060
1600	400	50	360	480	259	400	360	1440	80	4,61	9,6	WGDIM160040
1600	500	50	460	563	304	600	460	1440	80	5,28	11,2	WGDIM160050
1600	600	50	560	647	349	600	560	1440	80	5,96	12,7	WGDIM160060
Galvanische Oberfläche												
880	400	50	360	189	102	200	360	720	80	2,58	5,3	WGDIM088040
880	500	50	460	224	122	200	460	720	80	2,97	6,2	WGDIM088050
880	600	50	560	257	139	300	560	720	80	3,36	7,1	WGDIM088060
1120	400	50	360	238	129	200	360	960	80	3,26	6,7	WGDIM112040
1120	500	50	460	280	152	300	460	960	80	3,74	7,7	WGDIM112050
1120	600	50	560	323	174	300	560	960	80	4,22	8,8	WGDIM112060
1360	400	50	360	287	155	300	360	1200	80	3,93	8,0	WGDIM136040
1360	500	50	460	339	183	300	460	1200	80	4,51	9,3	WGDIM136050
1360	600	50	560	388	209	400	560	1200	80	5,09	10,6	WGDIM136060
1600	400	50	360	336	181	300	360	1440	80	4,61	9,3	WGDIM160040
1600	500	50	460	394	213	400	460	1440	80	5,28	10,8	WGDIM160050
1600	600	50	560	453	244	400	560	1440	80	5,96	12,3	WGDIM160060

Wir empfehlen: Set Winkeleck-Thermostatventil für Anschluss SX



Set einteilige Blende



Handtuchhalter Spark

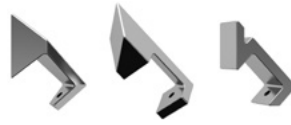

Verfügbare Größen:

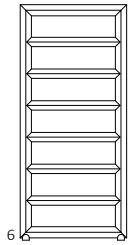

880 x 400
↕ ↔

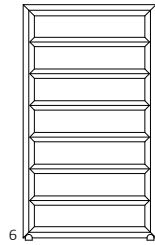

880 x 500

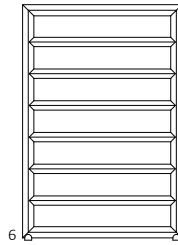

880 x 600

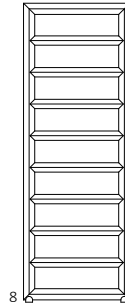

1120 x 400

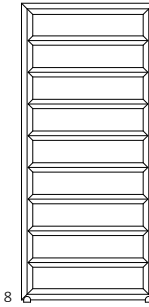

1120 x 500

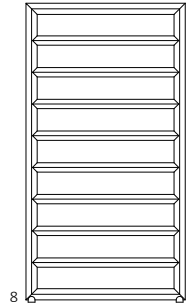

1120 x 600

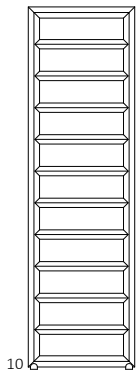

1360 x 400
↕ ↔

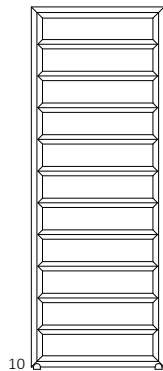

1360 x 500

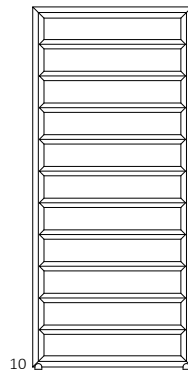

1360 x 600

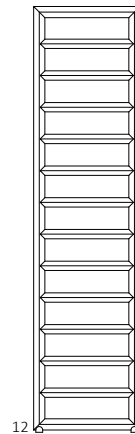

1600 x 400

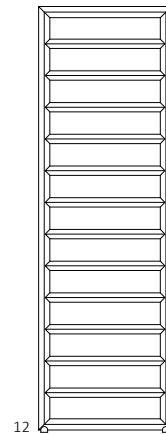

1600 x 500

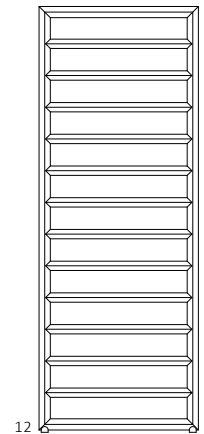

1600 x 600

SX

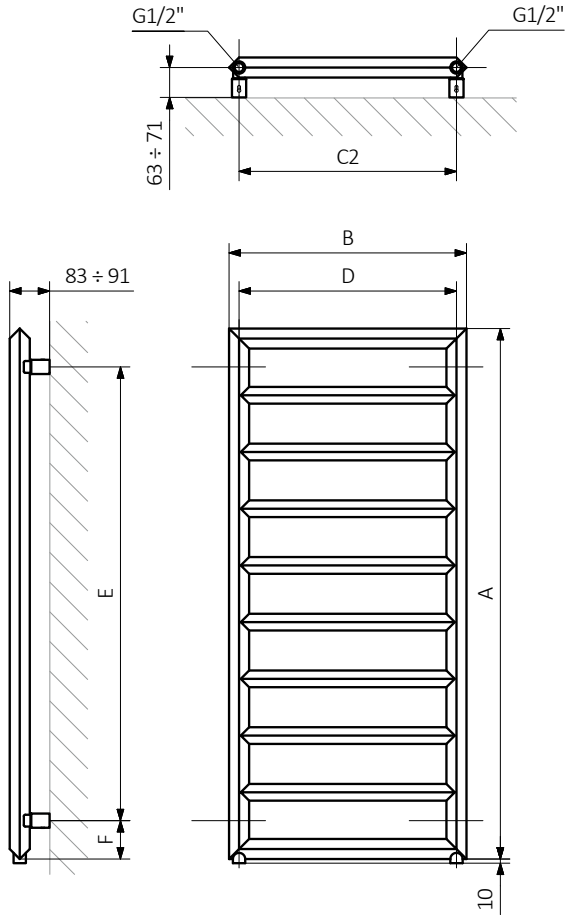

ZX

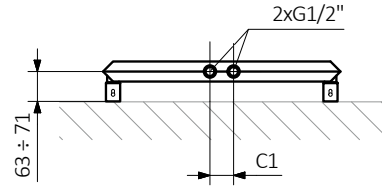

Z1

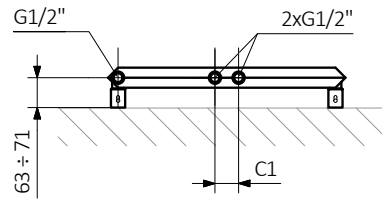

Z8

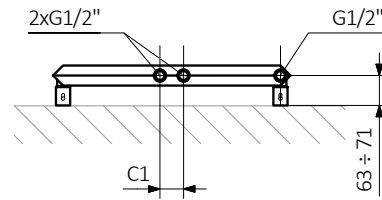

A – Höhe B – Breite C1-C5 – Anschlussabstand D – horizontaler Wandhalterungsabstand E – Vertikaler Wandhalterungsabstand
F – Abstand von der Achse der unteren Wandhalterung bis Unterkante des Kollektors

Kollektor:

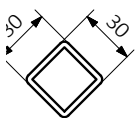

Rohr:

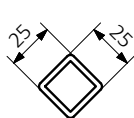

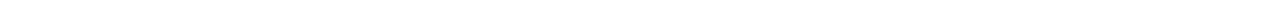



Standard Anschlussstypen:

Elektroheizkörper siehe Seite 321



Weitere mögliche Anschlussstypen:



Verfügbare Größen:

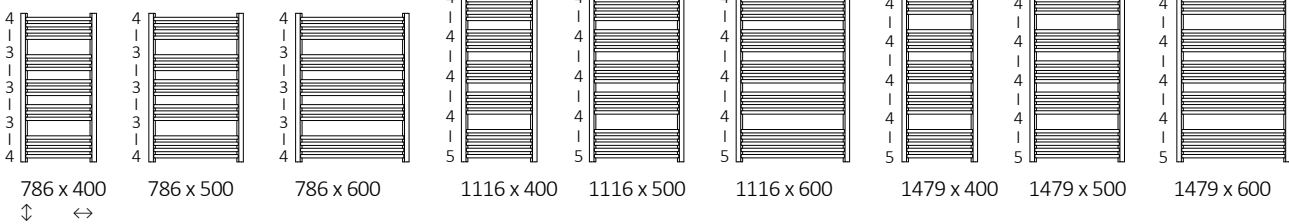

Technische Daten:

Betriebsdruck: 1000 kPa

Maximale Betriebstemperatur: 95°C

A ↓ [mm]	B ↔ [mm]	C2 [mm]	75/65/20°C [W]	55/45/20°C [W]	 [W]	D [mm]	E [mm]	F [mm]	 [dm²]	 [kg]	Artikelnummer <small>(Konfigurations code s. 662)</small>
Pulverlack											
786	400	370	296	161	300	240	626	80	2,13	4,77	WGDOM078040
786	500	470	369	199	400	340	626	80	2,54	5,69	WGDOM078050
786	600	570	435	235	400	440	626	80	2,86	6,61	WGDOM078060
1116	400	370	413	222	400	240	956	80	3,27	7,09	WGDOM111040
1116	500	470	513	274	600	340	956	80	3,76	8,49	WGDOM111050
1116	600	570	620	331	600	440	956	80	4,25	9,89	WGDOM111060
1479	400	370	533	284	600	240	1319	80	4,31	9,28	WGDOM147040
1479	500	470	663	346	600	340	1319	80	4,95	11,12	WGDOM147050
1479	600	570	800	425	800	440	1319	80	5,59	12,95	WGDOM147060
Galvanische Oberfläche											
786	400	370	207	106	200	240	626	80	2,13	4,58	WGDOM078040
786	500	470	258	132	300	340	626	80	2,54	5,45	WGDOM078050
786	600	570	305	155	300	440	626	80	2,86	6,33	WGDOM078060
1116	400	370	289	147	300	240	956	80	3,27	6,79	WGDOM111040
1116	500	470	359	183	400	340	956	80	3,76	8,14	WGDOM111050
1116	600	570	434	221	400	440	956	80	4,25	9,48	WGDOM111060
1479	400	370	373	190	400	240	1319	80	4,31	8,90	WGDOM147040
1479	500	470	464	237	400	340	1319	80	4,95	10,66	WGDOM147050
1479	600	570	560	286	600	440	1319	80	5,59	12,42	WGDOM147060

Wir empfehlen: Set Winkeck-Thermostatventil mit T-Stück für Anschluss SX.



Set einteilige Blende



Heizpatrone REG 3



Handtuchhalter Yo!



SX

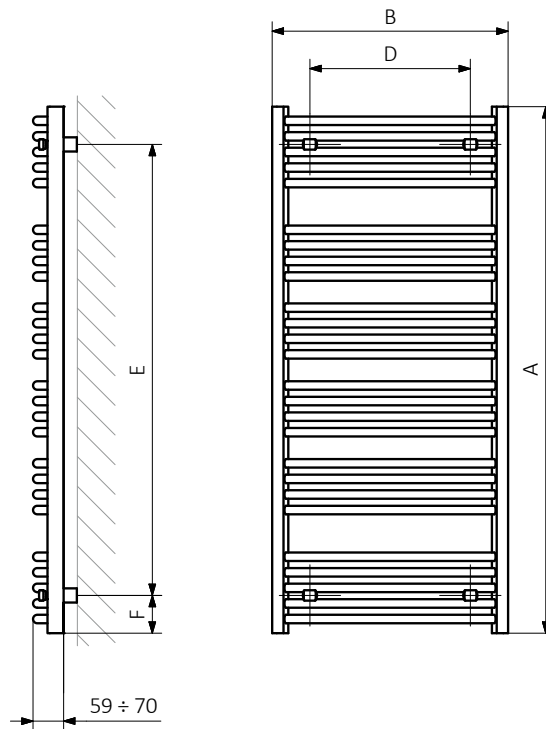
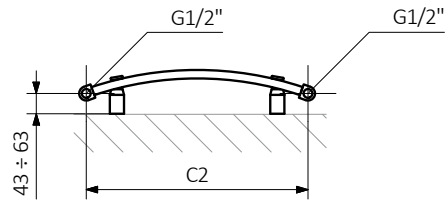

A - Höhe B - Breite C1-C5 - Anschlussabstand D - horizontaler Wandhalterungsabstand E - Vertikaler Wandhalterungsabstand F - Abstand von der Achse der unteren Wandhalterung bis Unterkante des Kollektors

Kollektor:

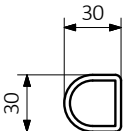

Rohr:

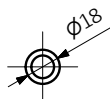



Standard Anschlussstypen:



Elektroheizkörper siehe Seite 321



Weitere mögliche Anschlussstypen:

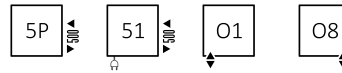
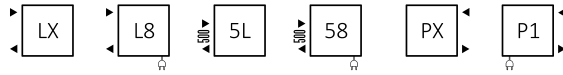

Verfügbare Größen:

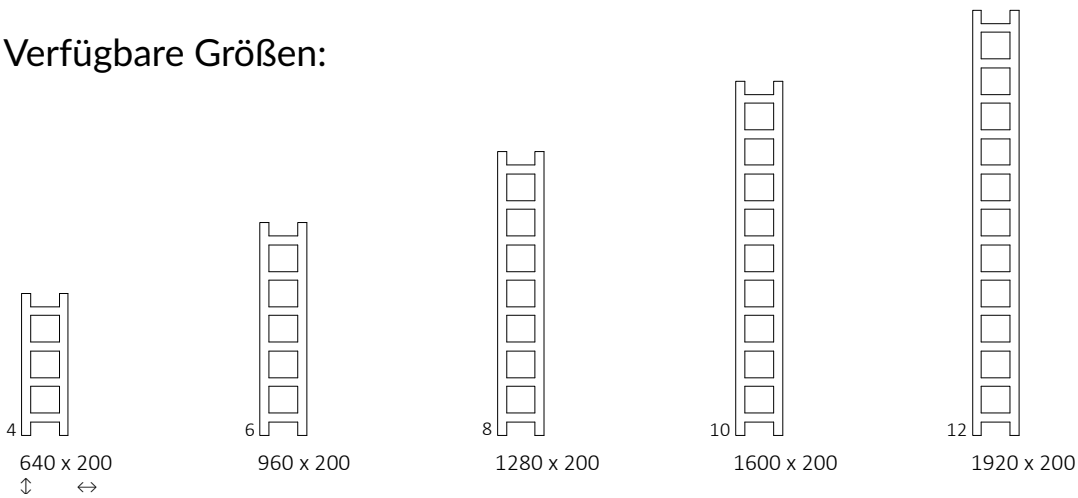

Technische Daten:

Betriebsdruck: 800 kPa

Maximale Betriebstemperatur: 95°C

A ↑ [mm]	B ↔ [mm]	C2 [mm]	75/65/20°C [W]	55/45/20°C [W]	☺ [W]	D [mm]	E [mm]	F [mm]	H [dm³]	📏 [kg]	Artikelnummer <small>(Konfigurations code s. 662)</small>
Pulverlack											
640	200	160	124	68	120	160	320	160	1,76	3,01	WGEAS064020
960	200	160	187	102	200	160	640	160	2,64	4,40	WGEAS096020
1280	200	160	251	136	300	160	960	160	3,52	5,78	WGEAS128020
1600	200	160	314	170	300	160	1280	160	4,40	7,17	WGEAS160020
1920	200	160	378	204	400	160	1600	160	5,27	8,55	WGEAS192020
Galvanische Oberfläche											
640	200	160	87	44	120	160	320	160	1,76	2,92	WGEAS064020
960	200	160	131	67	120	160	640	160	2,64	4,26	WGEAS096020
1280	200	160	176	90	200	160	960	160	3,52	5,60	WGEAS128020
1600	200	160	220	112	200	160	1280	160	4,40	6,94	WGEAS160020

Wir empfehlen: Heizpatronen
Steuerung KTX 4



Handtuchhalter
ZIP V 30



Ablage
Easy



SX

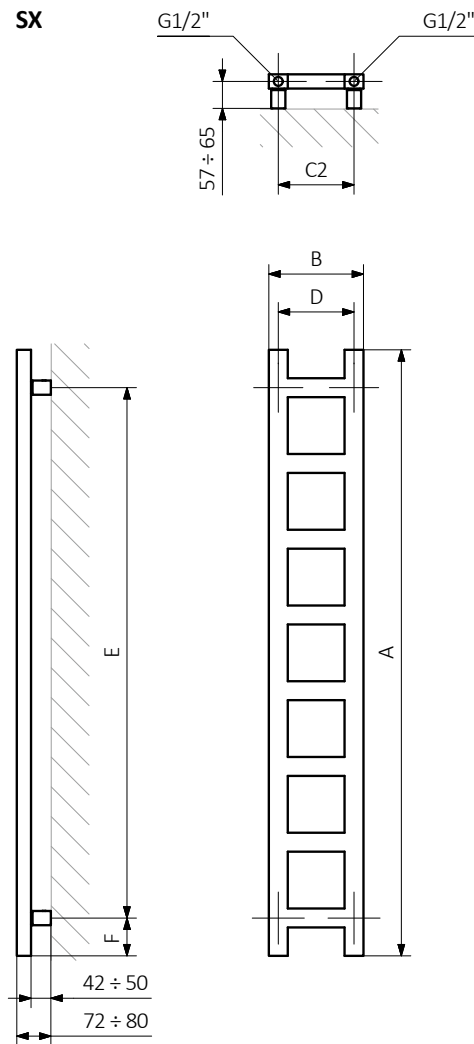

A - Höhe B - Breite C1-C5 - Anschlussabstand D - horizontaler Wandhalterungsabstand E - Vertikaler Wandhalterungsabstand F - Abstand von der Achse der unteren Wandhalterung bis Unterkante des Kollektors

Rohr:

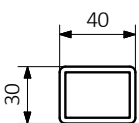



Standard Anschlussstypen:

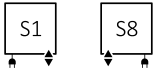

Elektroheizkörper siehe Seite 321

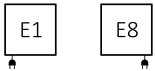

Verfügbare Größen:



Technische Daten:

Betriebsdruck: 800 kPa Maximale Betriebstemperatur: 82°C

A ↓ [mm]	B ↔ [mm]	75 65 20°C [W]	55 45 20°C [W]	[W]	D [mm]	E [mm]	F [mm]	[dm³]	[kg]	Artikelnummer <small>(Konfigurationscode s. 663)</small>
Pulverlack										
960	200	187	102	200	160	800	80	2,53	4,40	WZEAN096020
1280	200	251	136	300	160	1120	80	3,41	5,78	WZEAN128020
1600	200	314	170	300	160	1440	80	4,29	7,17	WZEAN160020
1920	200	378	204	400	160	1760	80	5,16	8,55	WZEAN192020
Galvanische Oberfläche										
960	200	131	67	120	160	800	80	2,53	4,26	WZEAN096020
1280	200	176	90	200	160	1120	80	3,41	5,60	WZEAN128020
1600	200	220	112	200	160	1440	80	4,29	6,94	WZEAN160020

Wir empfehlen: Set Lanzen-Thermostat-Verbund-eckventi für Anschluss S1 und S8



Abdeckblende



Handtuchhalter
ZIP V 30



Ablage Easy

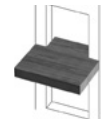

S8

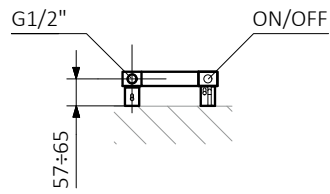

S1

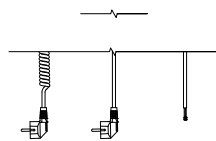
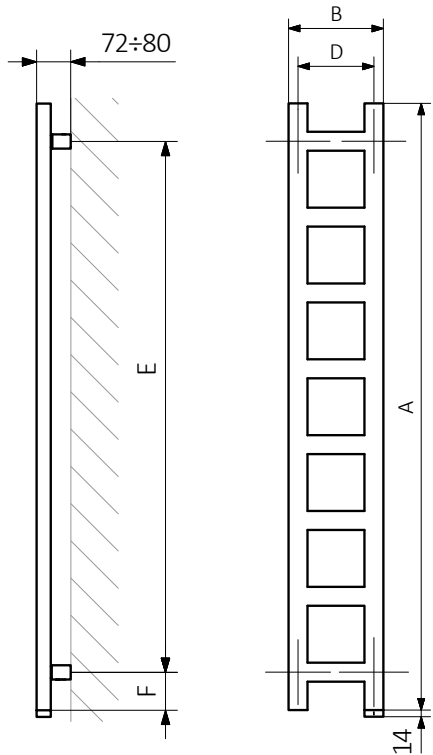
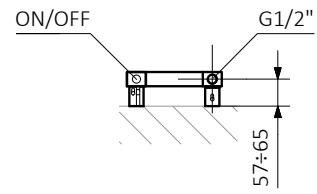

A - Höhe B - Breite C1-C5 - Anschlussabstand D - horizontaler Wandhalterungsabstand E - Vertikaler Wandhalterungsabstand F - Abstand von der Achse der unteren Wandhalterung bis Unterkante des Kollektors

Rohr:

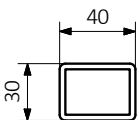



Standard Anschlussstypen:



Elektroheizkörper siehe Seite 321



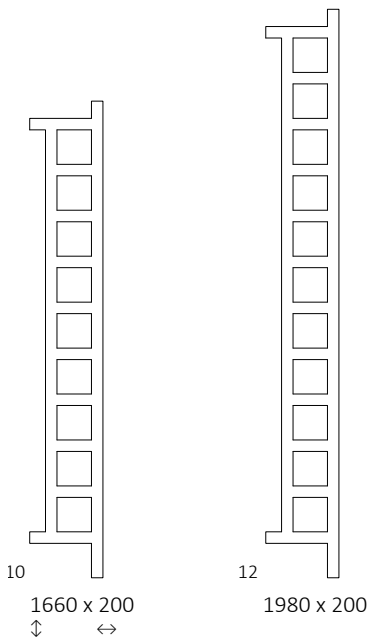

Verfügbare Größen:



Technische Daten:

Betriebsdruck: 800 kPa

Maximale Betriebstemperatur: 95°C

A ↓ [mm]	B ↔ [mm]	75/65/20°C [W]	55/45/20°C [W]	 [W]	E [mm]	F [mm]	 [dm³]	 [kg]	Artikelnummer <small>(Konfigurations code s. 662)</small>
1660	200	314	170	300	1440	21	4,40	7,17	WGEAW166020
1980	200	378	204	400	1760	21	5,27	8,55	WGEAW198020

Wir empfehlen: Set Lanzen-Thermostat-Verbindungsventil für Anschluss O1



Abdeckblende



Handtuchhalter
ZIP V 30



Ablage
Easy



O1

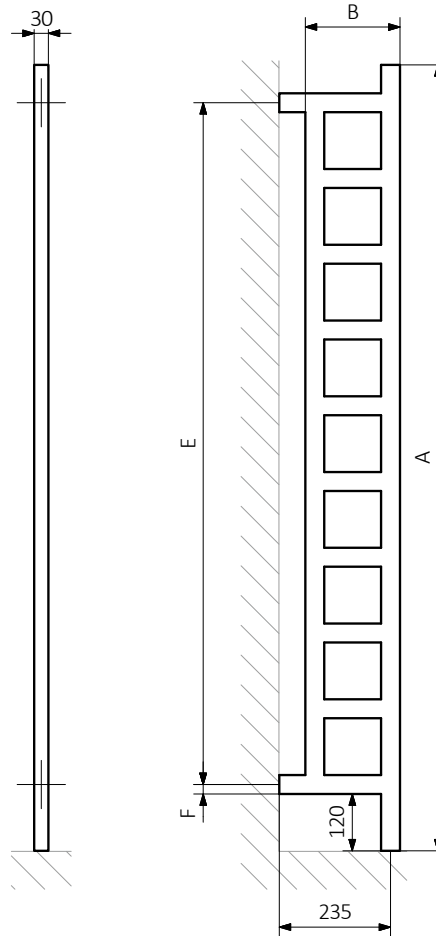
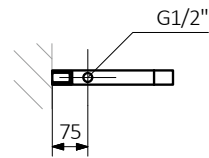

A - Höhe B - Breite C1-C5 - Anschlussabstand D - horizontaler Wandhalterungsabstand E - Vertikaler Wandhalterungsabstand F - Abstand von der Achse der unteren Wandhalterung bis Unterkante des Kollektors

Rohr:

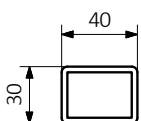



Standard Anschlussstypen:



Elektroheizkörper siehe Seite 321



Weitere mögliche Anschlussstypen:

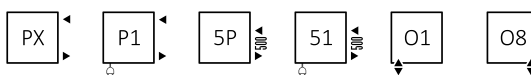
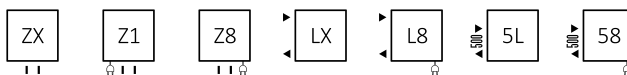

Technische Daten:

Betriebsdruck: 1000 kPa Maximale Betriebstemperatur: 95°C

A ↓ [mm]	B ↔ [mm]	C2 [mm]	75 65 20°C [W]	55 45 20°C [W]	[W]	D [mm]	E [mm]	F [mm]	[dm³]	[kg]	Artikelnummer <small>(Konfigurations code s. 662)</small>
Pulverlack											
660	400	370	241	128	300	370	480	90	2,18	4,48	WGFIN066040
660	430	400	255	136	300	400	480	90	2,29	4,72	WGFIN066043
660	480	450	280	149	300	450	480	90	2,46	5,12	WGFIN066048
660	500	470	289	154	300	470	480	90	2,54	5,27	WGFIN066050
660	530	500	304	162	300	500	480	90	2,64	5,52	WGFIN066053
660	580	550	327	175	300	550	480	90	2,82	5,92	WGFIN066058
660	600	570	336	180	400	570	480	90	2,89	6,08	WGFIN066060
660	630	600	350	188	400	600	480	90	3,00	6,32	WGFIN066063
660	680	650	373	200	400	650	480	90	3,18	6,76	WGFIN066068
900	400	370	322	172	300	370	720	90	2,93	6,00	WGFIN090040
900	430	400	342	182	400	400	720	90	3,08	6,32	WGFIN090043
900	480	450	375	200	400	450	720	90	3,32	6,85	WGFIN090048
900	500	470	388	206	400	470	720	90	3,41	7,06	WGFIN090050
900	530	500	407	217	400	500	720	90	3,55	7,39	WGFIN090053
900	580	550	438	234	400	550	720	90	3,79	7,92	WGFIN090058
900	600	570	451	241	400	570	720	90	3,89	8,14	WGFIN090060
900	630	600	469	251	400	600	720	90	4,03	8,46	WGFIN090063
900	680	650	500	267	600	650	720	90	4,27	8,95	WGFIN090068
1140	400	370	405	216	400	370	960	90	3,69	7,52	WGFIN114040
1140	430	400	430	228	400	400	960	90	3,87	7,92	WGFIN114043
1140	480	450	471	250	400	450	960	90	4,17	8,59	WGFIN114048
1140	500	470	487	259	600	470	960	90	4,29	8,86	WGFIN114050
1140	530	500	511	272	600	500	960	90	4,47	9,26	WGFIN114053
1140	580	550	550	293	600	550	960	90	4,76	9,93	WGFIN114058
1140	600	570	566	301	600	570	960	90	4,88	10,20	WGFIN114060
1140	630	600	589	314	600	600	960	90	5,06	10,59	WGFIN114063
1140	680	650	628	335	600	650	960	90	5,36	11,24	WGFIN114068
1380	400	370	488	260	600	370	1200	90	4,44	9,04	WGFIN138040

Wir empfehlen: Set Winkeleck-Thermostatventil mit T-Stück für Anschluss SX.





Set einteilige Blende





Handtuchhalter Yo!



A ↓ [mm]	B ↔ [mm]	C2 [mm]	75/65/20°C [W]	55/45/20°C [W]	 [W]	D [mm]	E [mm]	F [mm]	 [dm ²]	 [kg]	Artikelnummer <small>(Konfigurations code s. 662)</small>
1380	430	400	518	275	600	400	1200	90	4,66	9,53	WGFIN138043
1380	480	450	568	301	600	450	1200	90	5,02	10,33	WGFIN138048
1380	500	470	587	311	600	470	1200	90	5,16	10,65	WGFIN138050
1380	530	500	616	327	600	500	1200	90	5,38	11,13	WGFIN138053
1380	580	550	664	352	600	550	1200	90	5,73	11,93	WGFIN138058
1380	600	570	683	363	800	570	1200	90	5,88	12,25	WGFIN138060
1380	630	600	711	378	800	600	1200	90	6,09	12,73	WGFIN138063
1380	680	650	757	402	800	650	1200	90	6,45	13,53	WGFIN138068
1620	400	370	573	304	600	370	1440	90	5,20	10,56	WGFIN162040
1620	430	400	608	322	600	400	1440	90	5,45	11,13	WGFIN162043
1620	480	450	666	353	600	450	1440	90	5,87	12,06	WGFIN162048
1620	500	470	689	365	800	470	1440	90	6,04	12,44	WGFIN162050
1620	530	500	723	383	800	500	1440	90	6,29	13,00	WGFIN162053
1620	580	550	779	413	800	550	1440	90	6,70	13,93	WGFIN162058
1620	600	570	801	424	800	570	1440	90	6,87	14,31	WGFIN162060
1620	630	600	834	442	800	600	1440	90	7,12	14,87	WGFIN162063
1620	680	650	889	471	1000	650	1440	90	7,54	15,82	WGFIN162068
1860	400	370	660	350	600	370	1680	90	5,95	12,09	WGFIN186040
1860	430	400	700	370	800	400	1680	90	6,24	12,73	WGFIN186043
1860	480	450	767	405	800	450	1680	90	6,72	13,80	WGFIN186048
1860	500	470	793	419	800	470	1680	90	6,91	14,23	WGFIN186050
1860	530	500	832	440	800	500	1680	90	7,20	14,87	WGFIN186053
1860	580	550	897	474	1000	550	1680	90	7,67	15,94	WGFIN186058
1860	600	570	922	487	1000	570	1680	90	7,87	16,37	WGFIN186060
1860	630	600	960	507	1000	600	1680	90	8,15	17,01	WGFIN186063
1860	680	650	1023	541	1000	650	1680	90	8,63	18,11	WGFIN186068

Galvanische Oberfläche

660	400	370	169	90	200	370	480	90	2,18	4,31	WGFIN066040
660	430	400	179	95	200	400	480	90	2,29	4,54	WGFIN066043
660	480	450	196	104	200	450	480	90	2,46	4,92	WGFIN066048
660	500	470	202	108	200	470	480	90	2,54	5,07	WGFIN066050
660	530	500	212	113	200	500	480	90	2,64	5,30	WGFIN066053
660	580	550	229	123	200	550	480	90	2,82	5,69	WGFIN066058
660	600	570	235	126	200	570	480	90	2,89	5,84	WGFIN066060
660	630	600	245	132	300	600	480	90	3,00	6,07	WGFIN066063
660	680	650	261	140	300	650	480	90	3,18	6,50	WGFIN066068
900	400	370	225	120	200	370	720	90	2,93	5,77	WGFIN090040
900	430	400	240	127	300	400	720	90	3,08	6,08	WGFIN090043
900	480	450	262	140	300	450	720	90	3,32	6,59	WGFIN090048
900	500	470	272	144	300	470	720	90	3,41	6,79	WGFIN090050
900	530	500	285	152	300	500	720	90	3,55	7,10	WGFIN090053

A ↓ [mm]	B ↔ [mm]	C2 [mm]	75 [W]	55 [W]	 [W]	D [mm]	E [mm]	F [mm]	 [dm³]	 [kg]	Artikelnummer <small>(Konfigurations code s. 662)</small>
Galvanische Oberfläche											
900	580	550	307	164	300	550	720	90	3,79	7,61	WGFIN090058
900	600	570	316	169	300	570	720	90	3,89	7,82	WGFIN090060
900	630	600	329	176	300	600	720	90	4,03	8,13	WGFIN090063
900	680	650	350	187	400	650	720	90	4,27	8,60	WGFIN090068
1140	400	370	284	151	300	370	960	90	3,69	7,23	WGFIN114040
1140	430	400	301	160	300	400	960	90	3,87	7,62	WGFIN114043
1140	480	450	329	175	300	450	960	90	4,17	8,26	WGFIN114048
1140	500	470	341	181	400	470	960	90	4,29	8,52	WGFIN114050
1140	530	500	358	190	400	500	960	90	4,47	8,90	WGFIN114053
1140	580	550	385	205	400	550	960	90	4,76	9,54	WGFIN114058
1140	600	570	396	211	400	570	960	90	4,88	9,80	WGFIN114060
1140	630	600	413	220	400	600	960	90	5,06	10,18	WGFIN114063
1140	680	650	440	235	400	650	960	90	5,36	10,8	WGFIN114068
1380	400	370	342	182	400	370	1200	90	4,44	8,70	WGFIN138040
1380	430	400	363	193	400	400	1200	90	4,66	9,16	WGFIN138043
1380	480	450	397	211	400	450	1200	90	5,02	9,93	WGFIN138048
1380	500	470	411	218	400	470	1200	90	5,16	10,24	WGFIN138050
1380	530	500	431	229	400	500	1200	90	5,38	10,70	WGFIN138053
1380	580	550	465	246	400	550	1200	90	5,73	11,47	WGFIN138058
1380	600	570	478	254	400	570	1200	90	5,88	11,77	WGFIN138060
1380	630	600	498	265	600	600	1200	90	6,09	12,23	WGFIN138063
1380	680	650	530	281	600	650	1200	90	6,45	13,00	WGFIN138068
1620	400	370	401	213	400	370	1440	90	5,20	10,16	WGFIN162040
1620	430	400	426	225	400	400	1440	90	5,45	10,70	WGFIN162043
1620	480	450	466	247	400	450	1440	90	5,87	11,60	WGFIN162048
1620	500	470	482	256	600	470	1440	90	6,04	11,96	WGFIN162050
1620	530	500	506	268	600	500	1440	90	6,29	12,49	WGFIN162053
1620	580	550	545	289	600	550	1440	90	6,70	13,39	WGFIN162058
1620	600	570	561	297	600	570	1440	90	6,87	13,75	WGFIN162060
1620	630	600	584	309	600	600	1440	90	7,12	14,29	WGFIN162063
1620	680	650	622	330	600	650	1440	90	7,54	15,20	WGFIN162068

Verfügbare Größen:

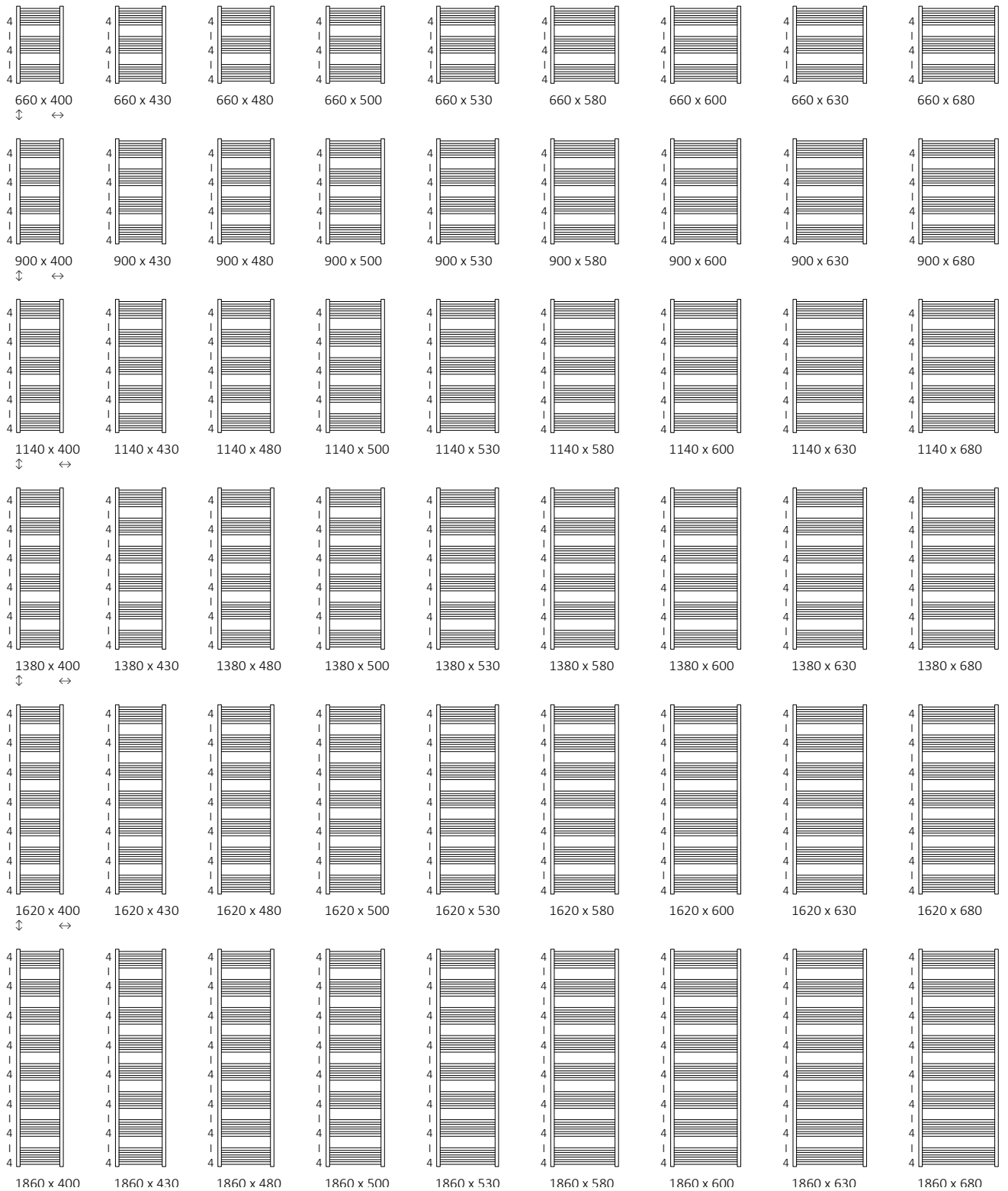

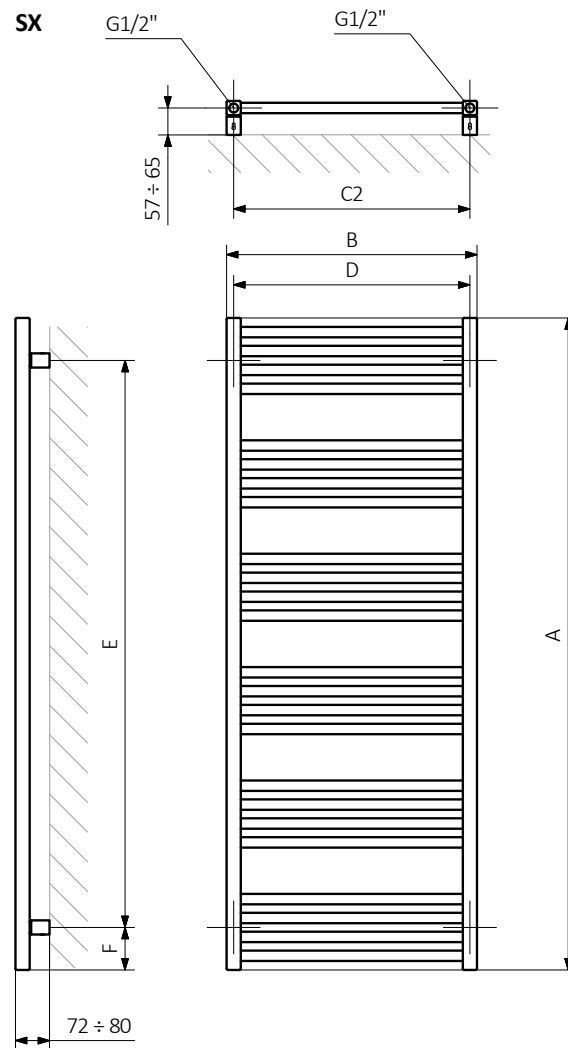

A – Höhe B – Breite C1-C5 – Anschlussabstand D – horizontaler Wandhalterungsabstand E – Vertikaler Wandhalterungsabstand F – Abstand von der Achse der unteren Wandhalterung bis Unterkante des Kollektors

Kollektor:

Rohr:

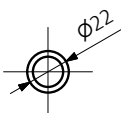
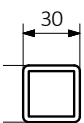





Standard Anschlussstypen:

Elektroheizkörper siehe Seite 321



Technische Daten:

Betriebsdruck: 1000 kPa Maximale Betriebstemperatur: 82°C

A ↓ [mm]	B ↔ [mm]	75/65/20°C [W]	55/45/20°C [W]	[W]	D [mm]	E [mm]	F [mm]	[dm³]	[kg]	Artikelnummer <small>(Konfigurations code s. 663)</small>
Pulverlack										
900	400	305	162	400	370	760	70	2,87	6,00	WZFIE090040
900	430	342	182	400	400	760	70	3,01	6,32	WZFIE090043
900	480	375	200	400	450	760	70	3,25	6,85	WZFIE090048
900	500	382	203	400	470	760	70	3,35	7,07	WZFIE090050
900	530	407	217	400	500	760	70	3,49	7,39	WZFIE090053
900	580	438	234	400	550	760	70	3,73	7,92	WZFIE090058
900	600	458	244	400	570	760	70	3,82	8,14	WZFIE090060
900	630	469	251	400	600	760	70	3,97	8,46	WZFIE090063
900	680	500	267	400	650	760	70	4,21	8,99	WZFIE090068
1140	400	385	204	400	370	1000	70	3,62	7,52	WZFIE114040
1140	430	430	228	400	400	1000	70	3,80	7,92	WZFIE114043
1140	480	471	250	400	450	1000	70	4,10	8,59	WZFIE114048
1140	500	481	256	400	470	1000	70	4,22	8,86	WZFIE114050
1140	530	511	272	600	500	1000	70	4,40	9,26	WZFIE114053
1140	580	550	293	600	550	1000	70	4,70	9,93	WZFIE114058
1140	600	577	307	600	570	1000	70	4,82	10,19	WZFIE114060
1140	630	589	314	600	600	1000	70	5,00	10,59	WZFIE114063
1140	680	628	335	600	650	1000	70	5,30	11,26	WZFIE114068
1380	400	464	246	600	370	1240	70	4,38	9,04	WZFIE138040
1380	430	518	275	600	400	1240	70	4,59	9,53	WZFIE138043
1380	480	568	301	600	450	1240	70	4,95	10,33	WZFIE138048
1380	500	580	308	600	470	1240	70	5,09	10,65	WZFIE138050
1380	530	616	327	600	500	1240	70	5,31	11,13	WZFIE138053
1380	580	664	352	600	550	1240	70	5,67	11,93	WZFIE138058
1380	600	696	370	600	570	1240	70	5,81	12,25	WZFIE138060
1380	630	711	378	800	600	1240	70	6,03	12,73	WZFIE138063
1380	680	757	402	800	650	1240	70	6,38	13,53	WZFIE138068
1620	400	543	287	800	370	1480	70	5,13	10,57	WZFIE162040
1620	430	608	322	600	400	1480	70	5,38	11,13	WZFIE162043
1620	480	666	353	600	450	1480	70	5,80	12,06	WZFIE162048

Wir empfehlen: Set Lanzen-Thermostat-Verbund-eckventil für Anschluss S1 und S8





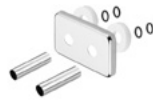

Abdeckblende



Handtuchhalter



A ↑ [mm]	B ↔ [mm]	75/65/20°C [W]	55/45/20°C [W]	 [W]	D [mm]	E [mm]	F [mm]	H [dm³]	 [kg]	Artikelnummer <small>(Konfigurationscode s. 663)</small>
1620	500	679	359	600	470	1480	70	5,97	12,44	WZFIE162050
1620	530	723	383	800	500	1480	70	6,22	13,00	WZFIE162053
1620	580	779	413	800	550	1480	70	6,64	13,93	WZFIE162058
1620	600	815	432	800	570	1480	70	6,81	14,31	WZFIE162060
1620	630	834	442	800	600	1480	70	7,06	14,87	WZFIE162063
1620	680	889	471	800	650	1480	70	7,47	15,80	WZFIE162068
1860	400	623	329	800	370	1720	70	5,89	12,09	WZFIE186040
1860	430	700	370	800	400	1720	70	6,18	12,73	WZFIE186043
1860	480	767	405	800	450	1720	70	6,65	13,80	WZFIE186048
1860	500	778	411	800	470	1720	70	6,84	14,23	WZFIE186050
1860	530	832	440	800	500	1720	70	7,13	14,87	WZFIE186053
1860	580	897	474	1000	550	1720	70	7,61	15,94	WZFIE186058
1860	600	934	493	1000	570	1720	70	7,80	16,37	WZFIE186060
1860	630	960	507	1000	600	1720	70	8,09	17,01	WZFIE186063
1860	680	1023	541	1000	650	1720	70	8,56	18,08	WZFIE186068
Galvanische Oberfläche										
900	400	214	113	200	370	760	70	2,87	5,77	WZFIE090040
900	430	240	127	300	400	760	70	3,01	6,08	WZFIE090043
900	480	262	140	300	450	760	70	3,25	6,59	WZFIE090048
900	500	267	142	300	470	760	70	3,35	6,79	WZFIE090050
900	530	285	152	300	500	760	70	3,49	7,10	WZFIE090053
900	580	307	164	300	550	760	70	3,73	7,61	WZFIE090058
900	600	321	171	300	570	760	70	3,82	7,82	WZFIE090060
900	630	329	176	300	600	760	70	3,97	8,13	WZFIE090063
900	680	350	187	300	650	760	70	4,21	8,64	WZFIE090068
1140	400	270	143	300	370	1000	70	3,62	7,23	WZFIE114040
1140	430	301	160	300	400	1000	70	3,80	7,62	WZFIE114043
1140	480	329	175	300	450	1000	70	4,10	8,26	WZFIE114048
1140	500	337	179	400	470	1000	70	4,22	8,52	WZFIE114050
1140	530	358	190	400	500	1000	70	4,40	8,90	WZFIE114053
1140	580	385	205	400	550	1000	70	4,70	9,54	WZFIE114058
1140	600	404	215	400	570	1000	70	4,82	9,80	WZFIE114060
1140	630	413	220	400	600	1000	70	5,00	10,18	WZFIE114063
1140	680	440	235	400	650	1000	70	5,30	10,82	WZFIE114068
1380	400	325	172	400	370	1240	70	4,38	8,70	WZFIE138040
1380	430	363	193	400	400	1240	70	4,59	9,16	WZFIE138043
1380	480	397	211	400	450	1240	70	4,95	9,93	WZFIE138048
1380	500	406	216	400	470	1240	70	5,09	10,24	WZFIE138050
1380	530	431	229	400	500	1240	70	5,31	10,70	WZFIE138053
1380	580	465	246	400	550	1240	70	5,67	11,47	WZFIE138058

A ↓ [mm]	B ↔ [mm]	75/65/20°C [W]	55/45/20°C [W]	 [W]	D [mm]	E [mm]	F [mm]	 [dm³]	 [kg]	Artikelnummer <small>(Konfigurations code s. 663)</small>
Galvanische Oberfläche										
1380	600	487	259	400	570	1240	70	5,81	11,77	WZFIE138060
1380	630	498	265	600	600	1240	70	6,03	12,23	WZFIE138063
1380	680	530	281	600	650	1240	70	6,38	13,00	WZFIE138068
1620	400	380	201	400	370	1480	70	5,13	10,16	WZFIE162040
1620	430	426	225	400	400	1480	70	5,38	10,70	WZFIE162043
1620	480	466	247	400	450	1480	70	5,80	11,60	WZFIE162048
1620	500	475	251	600	470	1480	70	5,97	11,96	WZFIE162050
1620	530	506	268	600	500	1480	70	6,22	12,49	WZFIE162053
1620	580	545	289	600	550	1480	70	6,64	13,39	WZFIE162058
1620	600	571	302	600	570	1480	70	6,81	13,75	WZFIE162060
1620	630	584	309	600	600	1480	70	7,06	14,29	WZFIE162063
1620	680	622	330	600	650	1480	70	7,47	15,18	WZFIE162068

Verfügbare Größen:

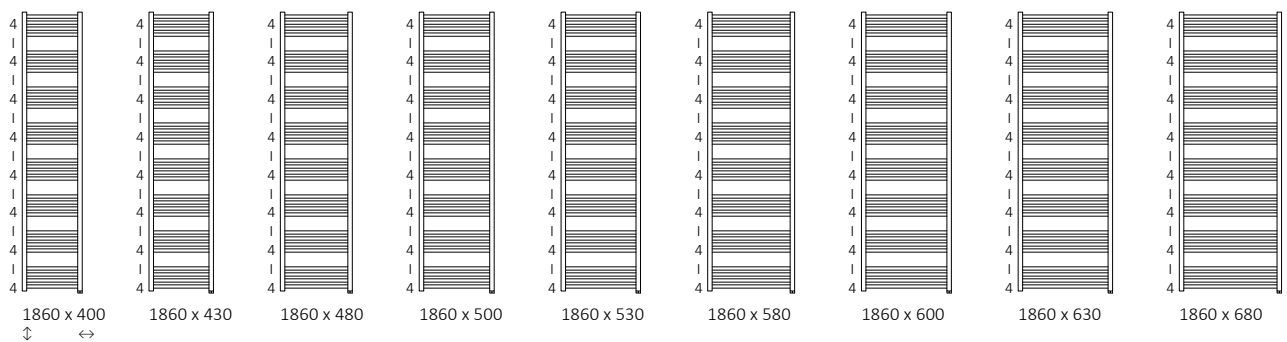
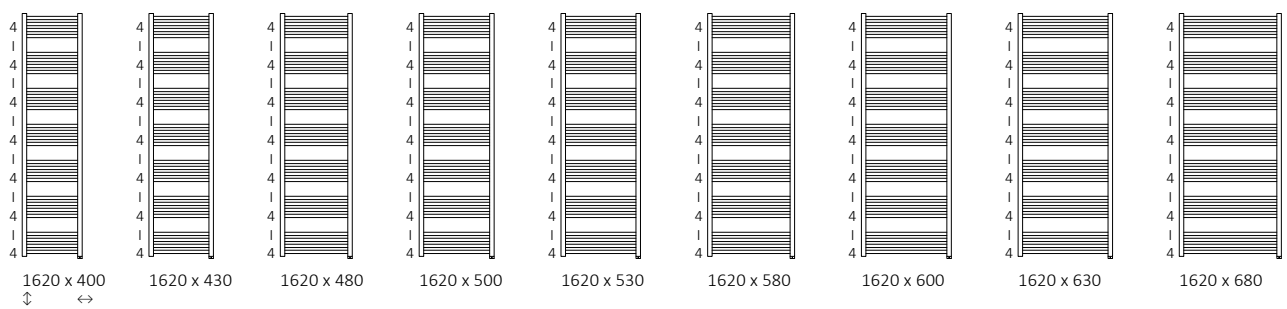
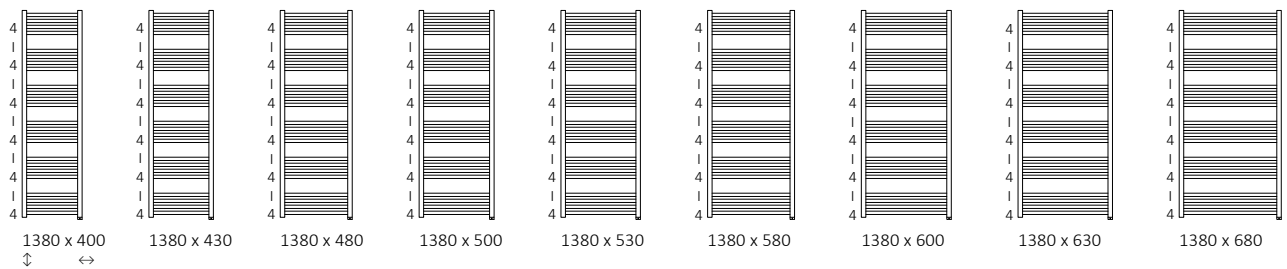
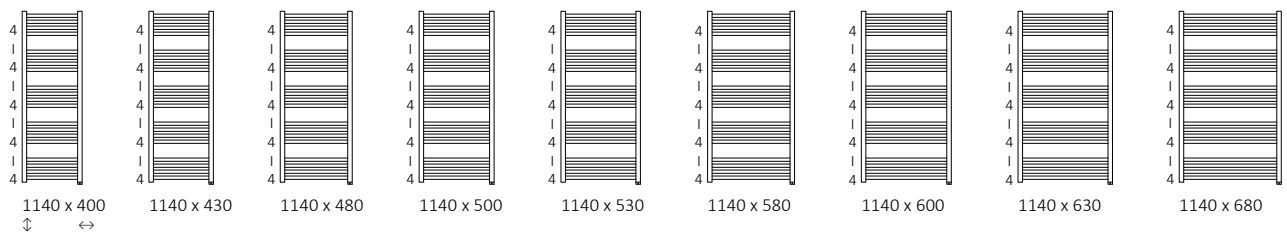
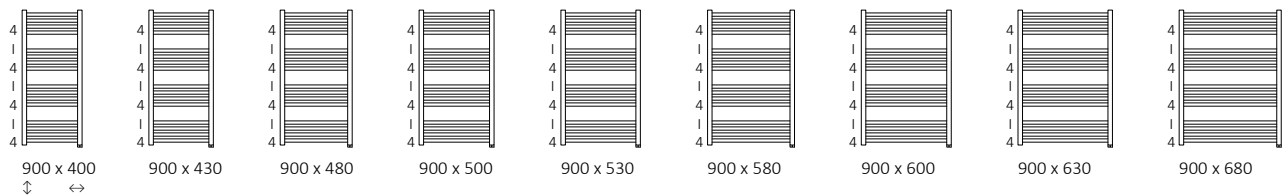

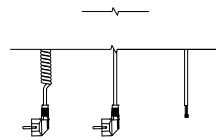
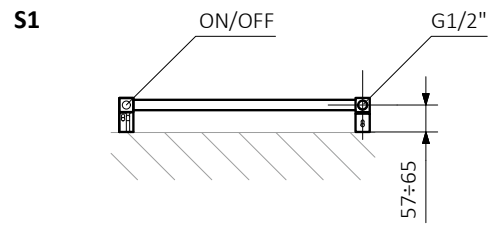
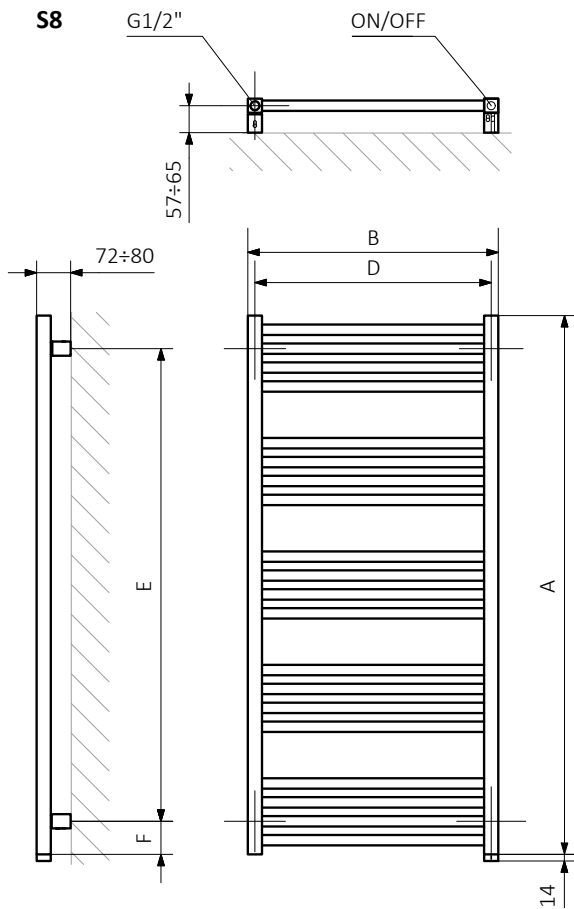

A – Höhe B – Breite C1-C5 – Anschlussabstand D – horizontaler Wandhaltungsabstand E – Vertikaler Wandhaltungsabstand F – Abstand von der Achse der unteren Wandhalterung bis Unterkante des Kollektors

Kollektor:

Rohr:

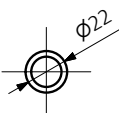
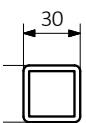

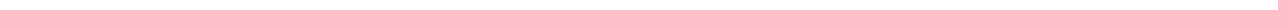



projekt: Krzysztof Kottowski

Standard Anschlussstypen:

A ↑ 465÷1545:



A ↑ 735÷1545



Elektroheizkörper siehe Seite 321



Weitere mögliche Anschlussstypen:

A ↑ 465÷1545:

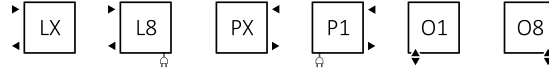

A ↑ 735÷1545



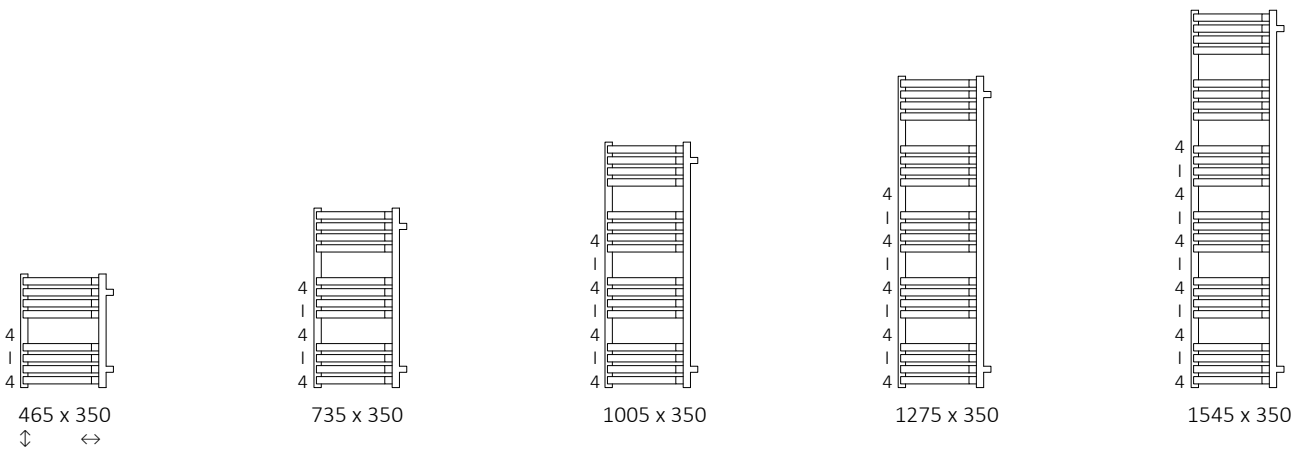

Verfügbare Größen:



Technische Daten:

Betriebsdruck: 1000 kPa

Maximale Betriebstemperatur: 95°C

A ↑ [mm]	B ↔ [mm]	C2 [mm]	75/65/20°C [W]	55/45/20°C [W]	 [W]	D [mm]	E [mm]	F [mm]	 [dm³]	 [kg]	Artikelnummer <small>(Konfigurations code s. 662)</small>
465	350	365	284	153	300	365	315	76	1,53	5,37	WGQIN046035
735	350	365	415	223	400	365	585	76	2,34	8,16	WGQIN073035
1005	350	365	546	293	600	365	855	76	3,16	10,94	WGQIN100035
1275	350	365	677	363	800	365	1125	76	3,98	13,73	WGQIN127035
1545	350	365	808	433	800	365	1395	76	4,80	16,52	WGQIN154035

Wir empfehlen: Set Winkeck-Thermostat-ventil für Anschluss SX



Set einteilige Blende



Handtuchhalter ZIP V 30

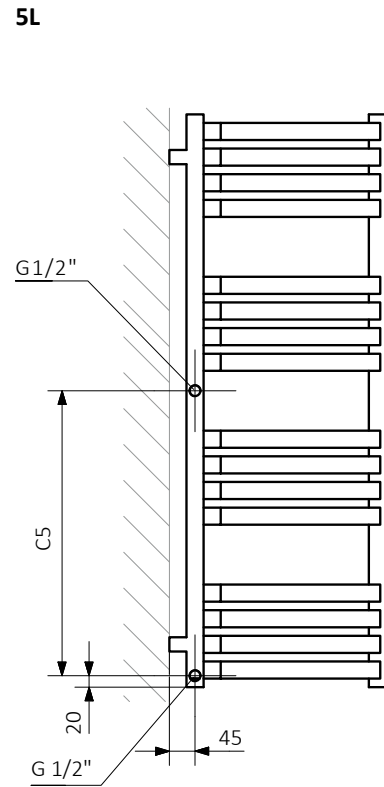
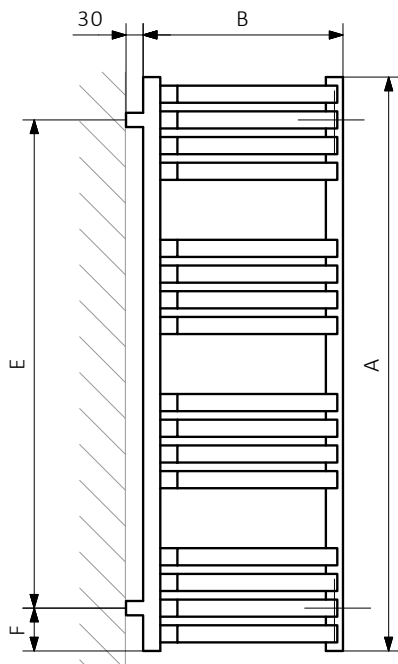
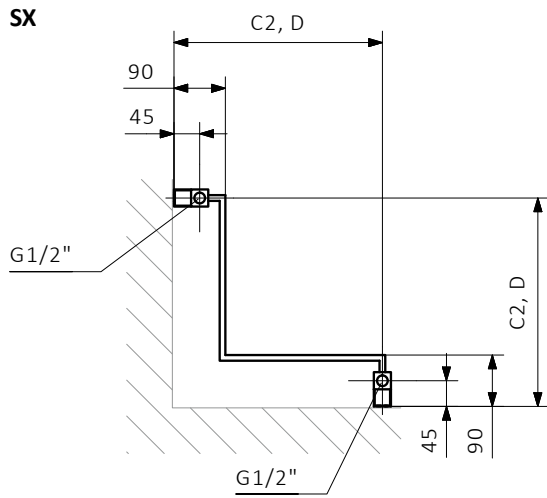

A – Höhe B – Breite C1-C5 – Anschlussabstand D – horizontaler Wandhalterungsabstand E – Vertikaler Wandhalterungsabstand F – Abstand von der Achse der unteren Wandhalterung bis Unterkante des Kollektors

Kollektor:

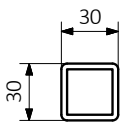

Rohr:

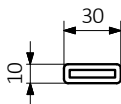



Standard Anschlussstypen:

Elektroheizkörper siehe Seite 321



Verfügbare Größen:

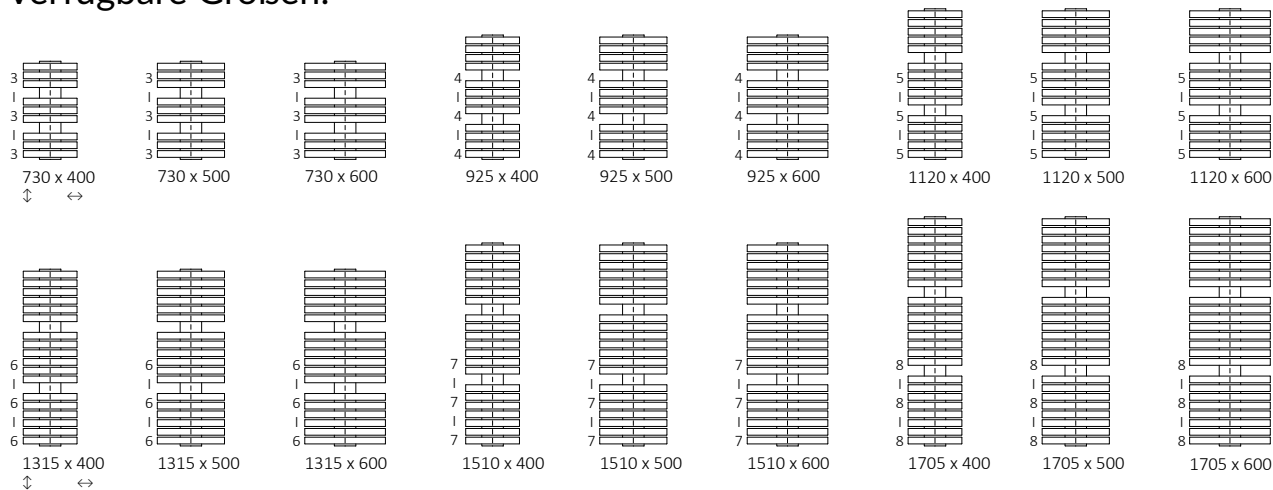

Technische Daten:

Betriebsdruck: 600 kPa

Maximale Betriebstemperatur: 95°C

A ↓ [mm]	B ↔ [mm]	C1 [mm]	75/65/20°C [W]	55/45/20°C [W]	[W]	D [mm]	E [mm]	F [mm]	[dm ²]	[kg]	Artikelnummer <small>(Konfigurations code s. 662)</small>
730	400	50	453	240	400	50	530	100	3,29	13,2	WGIRD073040
730	500	50	552	292	600	50	530	100	3,89	15,7	WGIRD073050
730	600	50	649	344	600	50	530	100	4,48	18,1	WGIRD073060
925	400	50	565	299	600	50	725	100	4,32	17,3	WGIRD092040
925	500	50	689	364	800	50	725	100	5,11	20,6	WGIRD092050
925	600	50	809	428	800	50	725	100	5,90	23,8	WGIRD092060
1120	400	50	676	358	800	50	920	100	5,36	21,4	WGIRD112040
1120	500	50	824	435	800	50	920	100	6,34	25,4	WGIRD112050
1120	600	50	969	511	1000	50	920	100	7,33	29,5	WGIRD112060
1315	400	50	788	417	800	50	1115	100	6,39	25,4	WGIRD131040
1315	500	50	960	506	1000	50	1115	100	7,57	30,3	WGIRD131050
1315	600	50	1128	593	1200	50	1115	100	8,76	35,2	WGIRD131060
1510	400	50	899	474	1000	50	1310	100	7,42	29,5	WGIRD151040
1510	500	50	1095	577	1000	50	1310	100	8,80	35,2	WGIRD151050
1510	600	50	1287	677	1200	50	1310	100	10,18	40,9	WGIRD151060
1705	400	50	1011	531	1000	50	1505	100	8,45	33,5	WGIRD170040
1705	500	50	1231	648	1200	50	1505	100	10,03	40,0	WGIRD170050
1705	600	50	1447	762	1500	50	1505	100	11,61	46,6	WGIRD170060

Wir empfehlen: Set Thermostat Verbunddeckventil mit Anschlussmöglichkeit für eine Heizpatrone für Anschlüsse YL und YP.



Abdeckblende



Heizpatrone MOA



ZX

130 ÷ 138 (B=400)
135 ÷ 143 (B=500)
140 ÷ 148 (B=600)

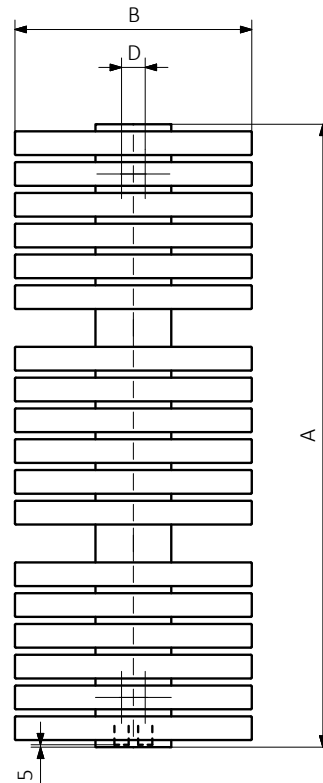
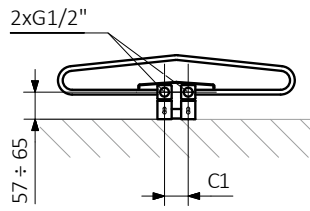
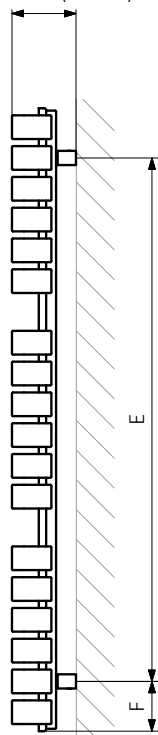

A – Höhe B – Breite C1-C5 – Anschlussabstand D – horizontaler Wandhalterungsabstand E – Vertikaler Wandhalterungsabstand F – Abstand von der Achse der unteren Wandhalterung bis Unterkante des Kollektors

Kollektor:

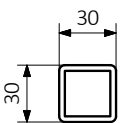

Rohr:

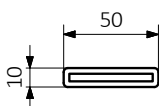



Standard Anschlusstypen:



Elektroheizkörper siehe Seite 321



Weitere mögliche Anschlusstypen:



Verfügbare Größen:

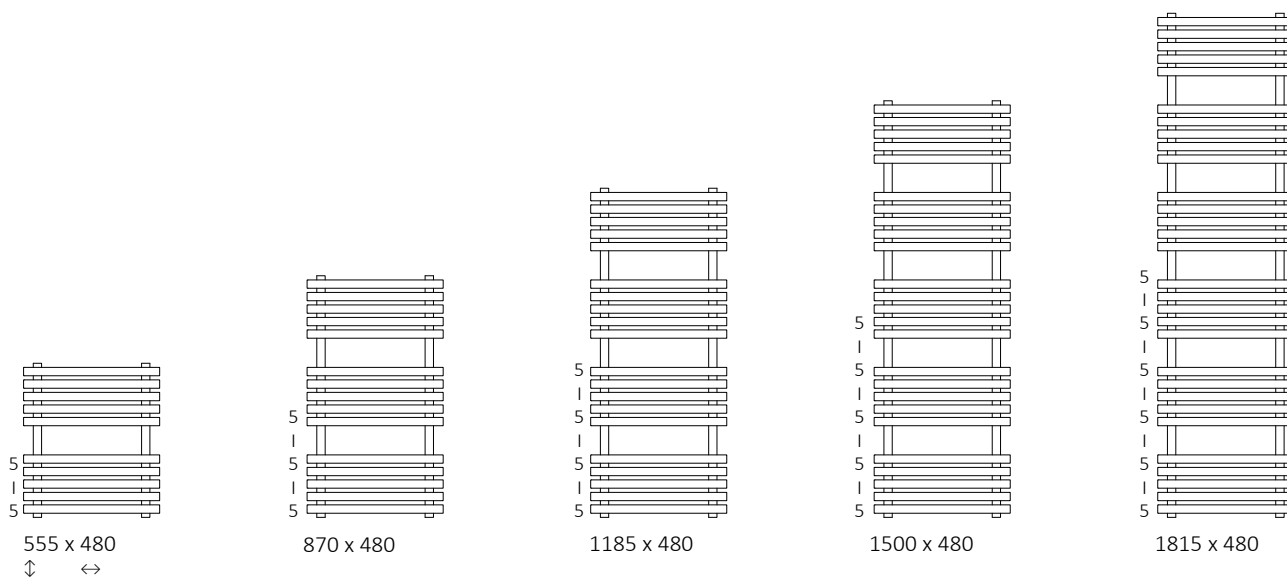

Technische Daten:

Betriebsdruck: 800 kPa

Maximale Betriebstemperatur: 95°C

A ↓ [mm]	B ↔ [mm]	C2 [mm]	75/65/20°C [W]	55/45/20°C [W]	[W]	D [mm]	E [mm]	F [mm]	[dm³]	[kg]	Artikelnummer <small>(Konfigurations code s. 662)</small>
555	480	390	324	176	300	390	375	90	1,97	7,09	WGKIO055048
870	480	390	476	255	400	390	690	90	3,01	10,70	WGKIO087048
1185	480	390	628	336	600	390	1005	90	4,05	14,31	WGKIO118048
1500	480	390	780	415	800	390	1320	90	5,09	17,92	WGKIO150048
1815	480	390	932	496	1000	390	1635	90	6,13	21,53	WGKIO181048

Wir empfehlen: Set Winkeck-Thermostat-ventil für Anschluss SX



Set einteilige Blende



SX

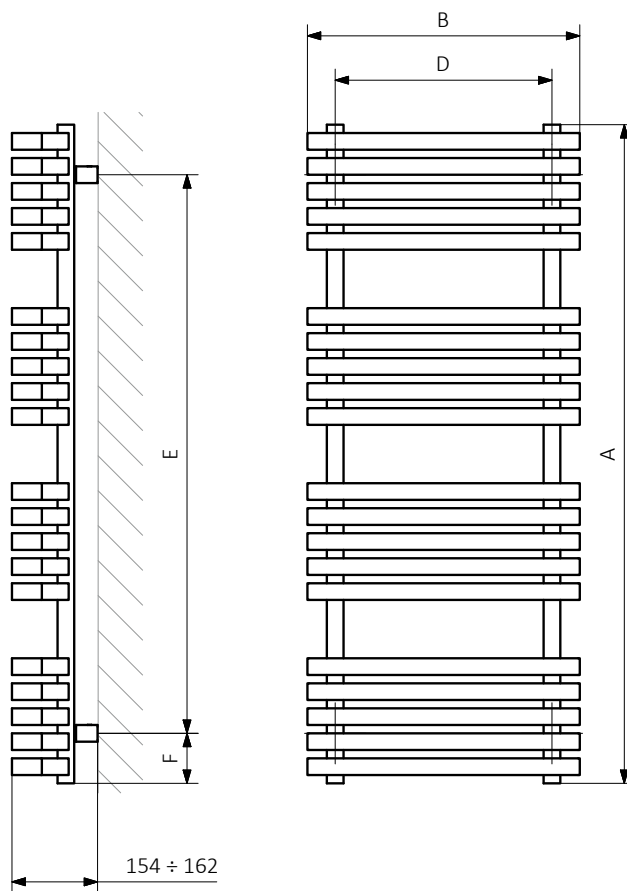
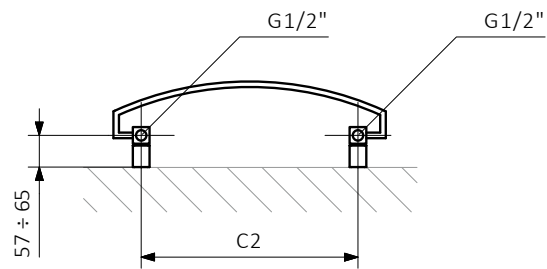

A – Höhe B – Breite C1-C5 – Anschlussabstand D – horizontaler Wandhalterungsabstand E – Vertikaler Wandhalterungsabstand F – Abstand von der Achse der unteren Wandhalterung bis Unterkante des Kollektors

Kollektor:

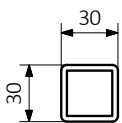

Rohr:

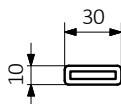



projekt: Krzysztof Kottowski

Standard Anschlussarten:

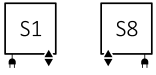

Elektroheizkörper siehe Seite 321

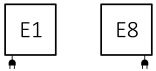

Verfügbare Größen:

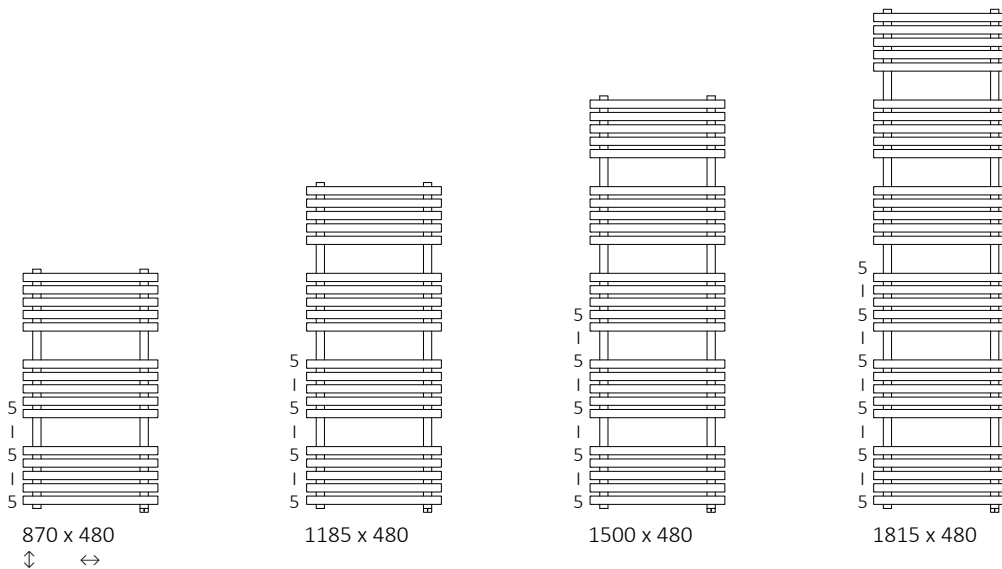

Technische Daten:

Betriebsdruck: 800 kPa

Maximale Betriebstemperatur: 82°C

A ↓ [mm]	B ↔ [mm]	75 65 20°C [W]	55 45 20°C [W]	☺ [W]	D [mm]	E [mm]	F [mm]	📦 [dm³]	📖 [kg]	Artikelnummer <small>(Konfigurations code s. 663)</small>
870	480	476	255	400	390	720	75	2,96	10,70	WZKIN087048
1185	480	628	336	600	390	1035	75	4,00	14,31	WZKIN118048
1500	480	780	415	800	390	1350	75	5,04	17,92	WZKIN150048
1815	480	932	496	1000	390	1665	75	6,08	21,53	WZKIN181048

Wir empfehlen: Set Lanzen-Thermostat-Verbund-eckventil für Anschluss S1 und S8

Abdeckblende

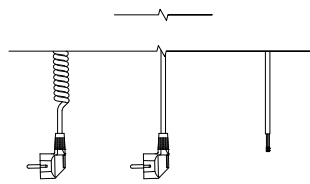
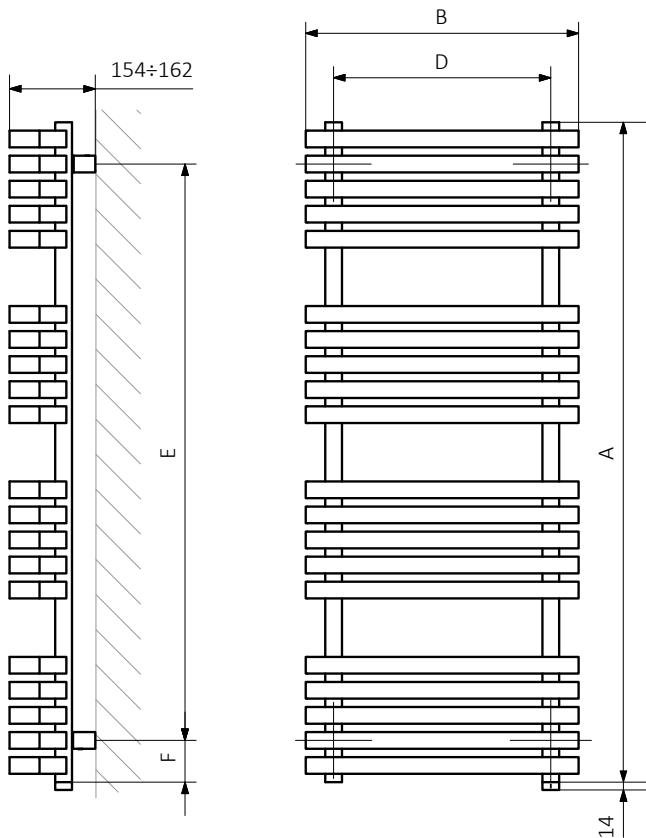
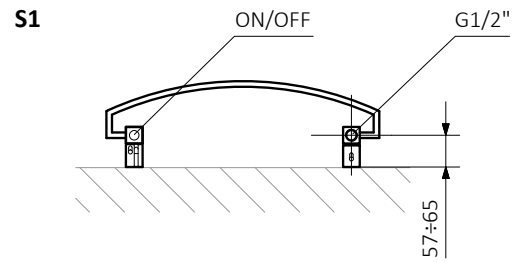
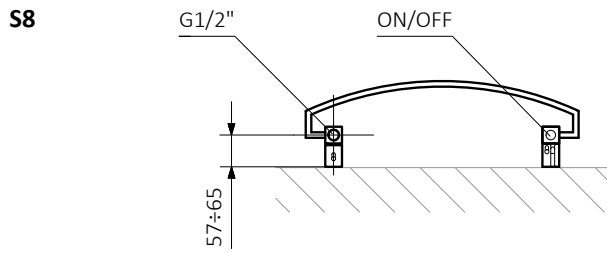

A – Höhe B – Breite C1-C5 – Anschlussabstand D – horizontaler Wandhalterungsabstand E – Vertikaler Wandhalterungsabstand F – Abstand von der Achse der unteren Wandhalterung bis Unterkante des Kollektors

Kollektor:

Rohr:

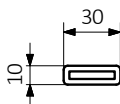
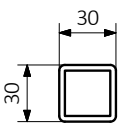



Standard Anschlussstypen:



Elektroheizkörper siehe Seite 321



Weitere mögliche Anschlussstypen:



Technische Daten:

Betriebsdruck: 1000 kPa Maximale Betriebstemperatur: 95°C

A \updownarrow [mm]	B \leftrightarrow [mm]	C2 [mm]	75/65/20°C [W]	55/45/20°C [W]	 [W]	D [mm]	E [mm]	F [mm]	 [dm³]	 [kg]	Artikelnummer <small>(Konfigurations code s. 662)</small>
Pulverlack											
660	400	364	243	131	300	356	480	90	2,23	4,60	WGLEN066040
660	436	400	262	141	300	392	480	90	2,36	4,89	WGLEN066043
660	486	450	287	154	300	442	480	90	2,54	5,28	WGLEN066048
660	500	464	294	158	300	456	480	90	2,59	5,40	WGLEN066050
660	536	500	312	168	300	492	480	90	2,72	5,69	WGLEN066053
660	586	550	337	181	400	542	480	90	2,90	6,09	WGLEN066058
660	600	564	343	185	400	556	480	90	2,95	6,20	WGLEN066060
660	636	600	361	194	400	592	480	90	3,08	6,48	WGLEN066063
660	686	650	385	207	400	642	480	90	3,26	6,89	WGLEN066068
900	400	364	326	175	300	356	720	90	3,01	6,16	WGLEN090040
900	436	400	351	189	400	392	720	90	3,18	6,54	WGLEN090043
900	486	450	385	207	400	442	720	90	3,42	7,07	WGLEN090048
900	500	464	394	212	400	456	720	90	3,48	7,23	WGLEN090050
900	536	500	418	225	400	492	720	90	3,65	7,62	WGLEN090053
900	586	550	451	242	400	542	720	90	3,89	8,15	WGLEN090058
900	600	564	460	247	400	556	720	90	3,96	8,29	WGLEN090060
900	636	600	484	260	600	592	720	90	4,13	8,68	WGLEN090063
900	686	650	516	277	600	642	720	90	4,37	9,21	WGLEN090068
1140	400	364	409	219	400	356	960	90	3,78	7,73	WGLEN114040
1140	436	400	440	236	400	392	960	90	3,99	8,21	WGLEN114043
1140	486	450	483	259	600	442	960	90	4,29	8,87	WGLEN114048
1140	500	464	495	265	600	456	960	90	4,38	9,06	WGLEN114050
1140	536	500	525	281	600	492	960	90	4,59	9,54	WGLEN114053
1140	586	550	566	303	600	542	960	90	4,89	10,21	WGLEN114058
1140	600	564	578	310	600	556	960	90	4,97	10,39	WGLEN114060
1140	636	600	607	325	600	592	960	90	5,19	10,87	WGLEN114063
1140	686	650	648	347	600	642	960	90	5,49	11,54	WGLEN114068

Wir empfehlen: Winkeleck-Regelventil für Anschluss SX









Set einteilige Blende



Handtuchhalter Yo!



A ↓ [mm]	B ↔ [mm]	C2 [mm]	75/65/20°C [W]	55/45/20°C [W]	 [W]	D [mm]	E [mm]	F [mm]	 [dm³]	 [kg]	Artikelnummer <small>(Konfigurations code s. 662)</small>
1380	400	364	493	264	600	356	1200	90	4,55	9,29	WGLEN138040
1380	436	400	530	284	600	392	1200	90	4,81	9,86	WGLEN138043
1380	486	450	582	311	600	442	1200	90	5,17	10,66	WGLEN138048
1380	500	464	596	319	600	456	1200	90	5,27	10,89	WGLEN138050
1380	536	500	632	338	600	492	1200	90	5,53	11,46	WGLEN138053
1380	586	550	682	365	600	542	1200	90	5,88	12,27	WGLEN138058
1380	600	564	696	372	800	556	1200	90	5,98	12,49	WGLEN138060
1380	636	600	731	391	800	592	1200	90	6,24	13,07	WGLEN138063
1380	686	650	780	417	800	642	1200	90	6,60	13,87	WGLEN138068
1620	400	364	577	308	600	356	1440	90	5,32	10,85	WGLEN162040
1620	436	400	621	332	600	392	1440	90	5,63	11,52	WGLEN162043
1620	486	450	682	364	800	442	1440	90	6,04	12,45	WGLEN162048
1620	500	464	698	373	800	456	1440	90	6,16	12,72	WGLEN162050
1620	536	500	741	396	800	492	1440	90	6,46	13,39	WGLEN162053
1620	586	550	799	427	800	542	1440	90	6,88	14,33	WGLEN162058
1620	600	564	815	435	800	556	1440	90	7,00	14,59	WGLEN162060
1620	636	600	857	457	800	592	1440	90	7,30	15,26	WGLEN162063
1620	686	650	914	488	1000	642	1440	90	7,72	16,20	WGLEN162068
1860	400	364	663	354	600	356	1680	90	6,10	12,42	WGLEN186040
1860	436	400	714	381	800	392	1680	90	6,44	13,18	WGLEN186043
1860	486	450	783	417	800	442	1680	90	6,92	14,25	WGLEN186048
1860	500	464	802	427	800	456	1680	90	7,05	14,54	WGLEN186050
1860	536	500	851	453	800	492	1680	90	7,40	15,32	WGLEN186053
1860	586	550	918	489	1000	542	1680	90	7,87	16,39	WGLEN186058
1860	600	564	937	499	1000	556	1680	90	8,01	16,68	WGLEN186060
1860	636	600	984	524	1000	592	1680	90	8,35	17,45	WGLEN186063
1860	686	650	1050	559	1000	642	1680	90	8,83	18,53	WGLEN186068
Galvanische Oberfläche											
660	400	364	170	92	200	356	480	90	2,23	4,60	WGLEN066040
660	436	400	183	99	200	392	480	90	2,36	4,70	WGLEN066043
660	486	450	201	108	200	442	480	90	2,54	5,08	WGLEN066048
660	500	464	206	111	200	456	480	90	2,59	5,19	WGLEN066050
660	536	500	218	118	200	492	480	90	2,72	5,47	WGLEN066053
660	586	550	236	127	300	542	480	90	2,90	5,85	WGLEN066058
660	600	564	240	130	200	556	480	90	2,95	5,96	WGLEN066060
660	636	600	253	136	300	592	480	90	3,08	6,23	WGLEN066063
660	686	650	270	145	300	642	480	90	3,26	6,62	WGLEN066068
900	400	364	228	123	300	356	720	90	3,01	5,92	WGLEN090040
900	436	400	246	132	300	392	720	90	3,18	6,29	WGLEN090043
900	486	450	270	145	300	442	720	90	3,42	6,80	WGLEN090048
900	500	464	276	148	300	456	720	90	3,48	6,95	WGLEN090050

A ↓ [mm]	B ↔ [mm]	C2 [mm]	75 65 20°C [W]	55 45 20°C [W]	 [W]	D [mm]	E [mm]	F [mm]	 [dm²]	 [kg]	Artikelnummer <small>(Konfigurations code s. 662)</small>
Galvanische Oberfläche											
900	536	500	293	158	300	492	720	90	3,65	7,32	WGLEN090053
900	586	550	316	169	300	542	720	90	3,89	7,83	WGLEN090058
900	600	564	322	173	300	556	720	90	3,96	7,97	WGLEN090060
900	636	600	339	182	300	592	720	90	4,13	8,34	WGLEN090063
900	686	650	361	194	400	642	720	90	4,37	8,85	WGLEN090068
1140	400	364	286	153	300	356	960	90	3,78	7,43	WGLEN114040
1140	436	400	308	165	300	392	960	90	3,99	7,89	WGLEN114043
1140	486	450	338	181	400	442	960	90	4,29	8,53	WGLEN114048
1140	500	464	347	186	400	456	960	90	4,38	8,71	WGLEN114050
1140	536	500	368	197	400	492	960	90	4,59	9,17	WGLEN114053
1140	586	550	396	212	400	542	960	90	4,89	9,81	WGLEN114058
1140	600	564	405	217	400	556	960	90	4,97	9,99	WGLEN114060
1140	636	600	425	228	400	592	960	90	5,19	10,45	WGLEN114063
1140	686	650	454	243	400	642	960	90	5,49	11,09	WGLEN114068
1380	400	364	345	185	400	356	1200	90	4,55	8,93	WGLEN138040
1380	436	400	371	199	400	392	1200	90	4,81	9,48	WGLEN138043
1380	486	450	407	218	400	442	1200	90	5,17	10,25	WGLEN138048
1380	500	464	417	223	400	456	1200	90	5,27	10,47	WGLEN138050
1380	536	500	442	237	400	492	1200	90	5,53	11,02	WGLEN138053
1380	586	550	477	256	600	542	1200	90	5,88	11,79	WGLEN138058
1380	600	564	487	260	400	556	1200	90	5,98	12,00	WGLEN138060
1380	636	600	512	274	400	592	1200	90	6,24	12,56	WGLEN138063
1380	686	650	546	292	400	642	1200	90	6,60	13,33	WGLEN138068
1620	400	364	404	216	400	356	1440	90	5,32	10,43	WGLEN162040
1620	436	400	435	232	400	392	1440	90	5,63	11,08	WGLEN162043
1620	486	450	477	255	600	442	1440	90	6,04	11,97	WGLEN162048
1620	500	464	489	261	600	456	1440	90	6,16	12,23	WGLEN162050
1620	536	500	519	277	600	492	1440	90	6,46	12,87	WGLEN162053
1620	586	550	559	299	600	542	1440	90	6,88	13,77	WGLEN162058
1620	600	564	571	305	400	556	1440	90	7,00	14,02	WGLEN162060
1620	636	600	600	320	600	592	1440	90	7,30	14,66	WGLEN162063
1620	686	650	640	342	600	642	1440	90	7,72	15,56	WGLEN162068

Verfügbare Größen:

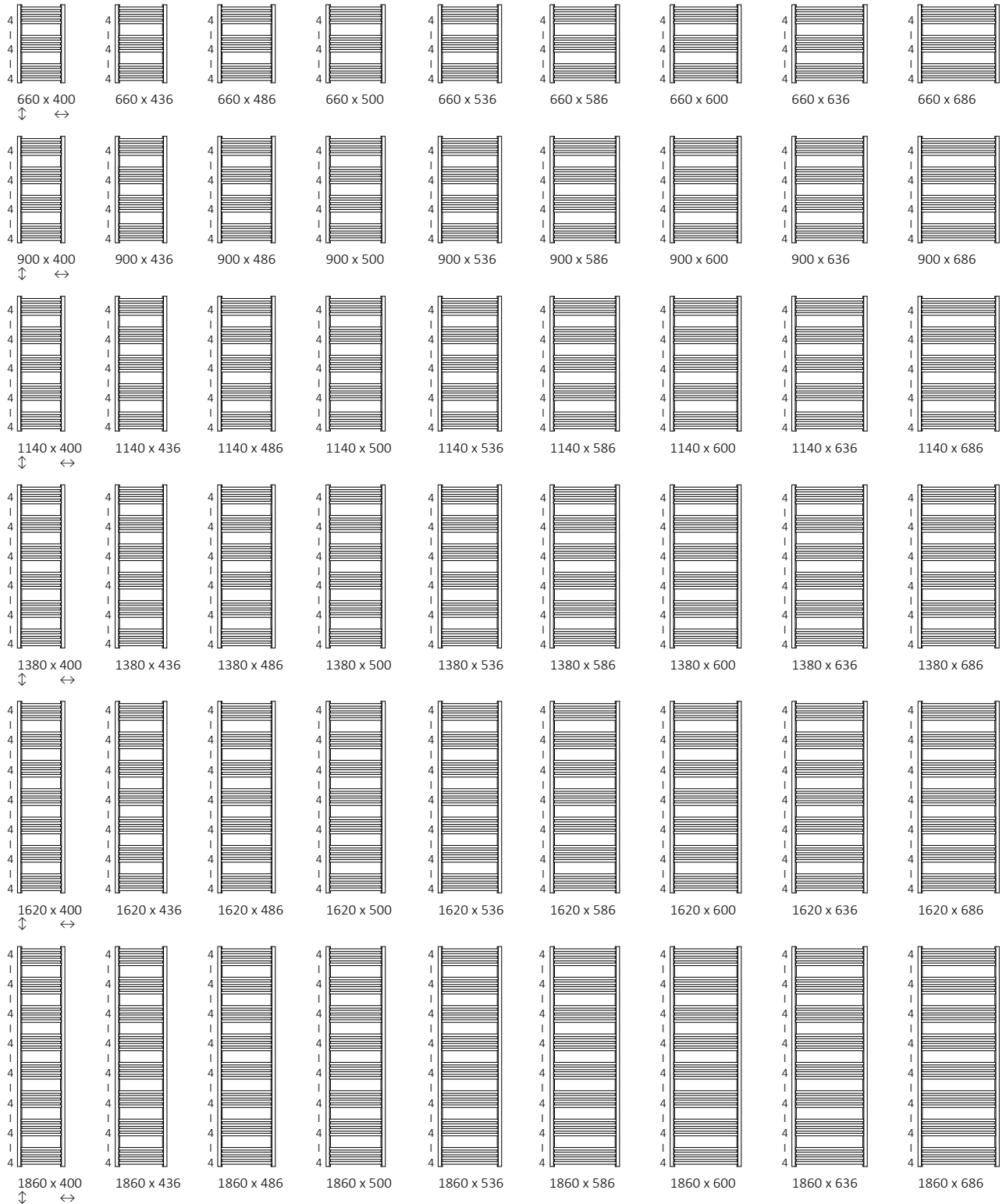

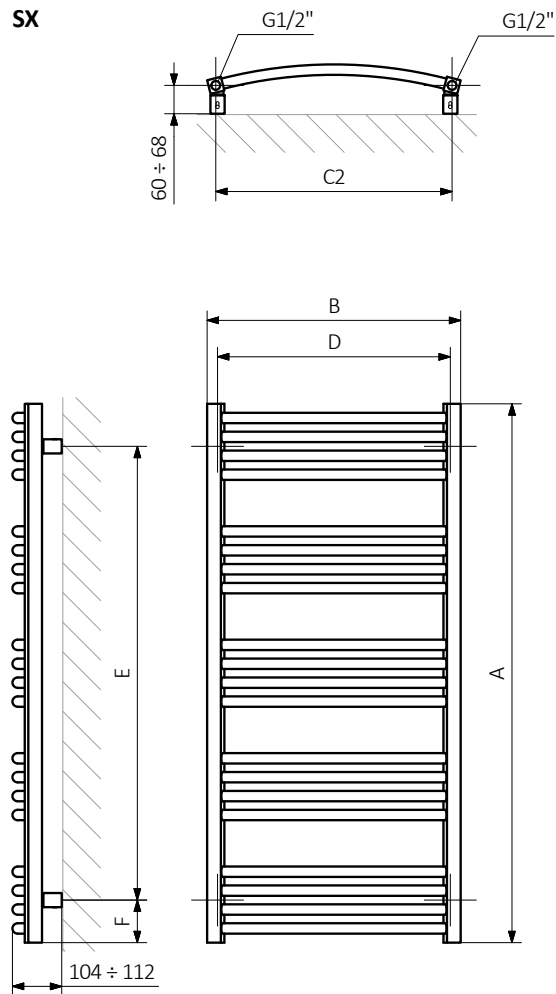

A – Höhe B – Breite C1-C5 – Anschlussabstand D – horizontaler Wandhalterungsabstand E – Vertikaler Wandhalterungsabstand F – Abstand von der Achse der unteren Wandhalterung bis Unterkante des Kollektors

Kollektor:

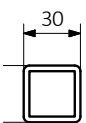

Rohr:

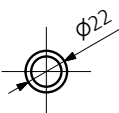





Standard Anschlussstypen:

A ↓ 300÷1700:



A ↓ 500÷1700:



Elektroheizkörper siehe Seite 321



Weitere mögliche Anschlussstypen:

A ↓ 300÷1700:



A ↓ 820÷1700:



Technische Daten:

Betriebsdruck: 1000 kPa

Maximale Betriebstemperatur: 95°C

A ↓ [mm]	B ↔ [mm]	C1 [mm]	C2 [mm]	75/65 20°C [W]	55/45 20°C [W]	☉ [W]	D [mm]	E [mm]	F [mm]	H [dm ²]	📏 [kg]	Artikelnummer <small>(Konfigurationscode s. 662)</small>
Pulverlack												
300	1000	50	970	290	159	-	970	120	90	2,43	5,28	WGLIM030100
300	1200	50	1170	347	191	-	1170	120	90	2,85	6,21	WGLIM030120
300	1400	50	1370	405	223	-	1370	120	90	3,26	7,15	WGLIM030140
500	300	50	270	144	79	120	270	320	90	1,50	3,06	WGLIM050030
500	400	50	370	192	105	200	370	320	90	1,79	3,72	WGLIM050040
500	500	50	470	241	131	200	470	320	90	2,09	4,39	WGLIM050050
500	600	50	570	282	153	300	570	320	90	2,39	5,06	WGLIM050060
500	700	50	670	324	176	300	670	320	90	2,69	5,73	WGLIM050070
500	1000	50	970	482	262	-	970	320	90	3,59	7,73	WGLIM050100
500	1200	50	1170	578	314	-	1170	320	90	4,18	9,07	WGLIM050120
500	1400	50	1370	675	367	-	1370	320	90	4,78	10,41	WGLIM050140
820	300	50	270	244	132	300	270	640	90	2,53	5,14	WGLIM082030
820	400	50	370	325	175	300	370	640	90	3,07	6,34	WGLIM082040
820	500	50	470	406	218	400	470	640	90	3,61	7,54	WGLIM082050
820	600	50	570	477	256	400	570	640	90	4,15	8,75	WGLIM082060
820	700	50	670	547	293	600	670	640	90	4,68	9,95	WGLIM082070
1140	300	50	270	345	185	400	270	960	90	3,57	7,22	WGLIM114030

Wir empfehlen: Set Thermostat Verbunddeckventil für Anschluss Z1 und Z8



Abdeckblende



Heizpatrone ONE



Handtuchhalter Yo!



A ↓ [mm]	B ↔ [mm]	C1 [mm]	C2 [mm]	75 65 20°C [W]	55 45 20°C [W]	☉ [W]	D [mm]	E [mm]	F [mm]	U [dm³]	⚖️ [kg]	Artikelnummer <small>(Konfigurations code s. 662)</small>
1140	400	50	370	460	247	400	370	960	90	4,35	8,96	WGLIM114040
1140	500	50	470	574	308	600	470	960	90	5,13	10,69	WGLIM114050
1140	600	50	570	675	361	800	570	960	90	5,90	12,43	WGLIM114060
1140	700	50	670	776	415	800	670	960	90	6,68	14,17	WGLIM114070
1460	300	50	270	449	240	400	270	1280	90	4,66	9,42	WGLIM146030
1460	400	50	370	599	319	600	370	1280	90	5,68	11,69	WGLIM146040
1460	500	50	470	748	399	800	470	1280	90	6,69	13,96	WGLIM146050
1460	600	50	570	879	468	800	570	1280	90	7,71	16,23	WGLIM146060
1460	700	50	670	1009	537	1000	670	1280	90	8,73	18,50	WGLIM146070
1700	300	50	270	527	280	600	270	1520	90	5,47	11,04	WGLIM170030
1700	400	50	370	703	374	800	370	1520	90	6,66	13,71	WGLIM170040
1700	500	50	470	878	466	800	470	1520	90	7,86	16,38	WGLIM170050
1700	600	50	570	1031	547	1000	570	1520	90	9,05	19,05	WGLIM170060
1700	700	50	670	1183	628	1200	670	1520	90	10,25	21,73	WGLIM170070

Galvanische Oberfläche

300	1000	50	970	203	104	-	970	120	90	2,43	5,07	WGLIM030100
300	1200	50	1170	243	124	-	1170	120	90	2,85	5,96	WGLIM030120
300	1400	50	1370	284	145	-	1370	120	90	3,26	6,86	WGLIM030140
500	300	50	270	101	51	120	270	320	90	1,50	2,94	WGLIM050030
500	400	50	370	134	69	120	370	320	90	1,79	3,58	WGLIM050040
500	500	50	470	169	86	200	470	320	90	2,09	4,22	WGLIM050050
500	600	50	570	197	101	200	570	320	90	2,39	4,86	WGLIM050060
500	700	50	670	227	116	200	670	320	90	2,69	5,50	WGLIM050070
500	1000	50	970	337	172	-	970	320	90	3,59	7,43	WGLIM050100
500	1200	50	1170	405	206	-	1170	320	90	4,18	8,71	WGLIM050120
500	1400	50	1370	473	241	-	1370	320	90	4,78	9,99	WGLIM050140
820	300	50	270	171	87	200	270	640	90	2,53	4,94	WGLIM082030
820	400	50	370	228	116	200	370	640	90	3,07	6,10	WGLIM082040
820	500	50	470	284	145	300	470	640	90	3,61	7,25	WGLIM082050
820	600	50	570	334	170	400	570	640	90	4,15	8,40	WGLIM082060
820	700	50	670	383	195	400	670	640	90	4,68	9,55	WGLIM082070
1140	300	50	270	242	123	300	270	960	90	3,57	6,94	WGLIM114030
1140	400	50	370	322	164	300	370	960	90	4,35	8,61	WGLIM114040
1140	500	50	470	402	205	400	470	960	90	5,13	10,27	WGLIM114050
1140	600	50	570	473	241	400	570	960	90	5,90	11,94	WGLIM114060
1140	700	50	670	543	277	600	670	960	90	6,68	13,61	WGLIM114070
1460	300	50	270	314	160	300	270	1280	90	4,66	9,06	WGLIM146030
1460	400	50	370	419	214	400	370	1280	90	5,68	11,24	WGLIM146040
1460	500	50	470	524	267	600	470	1280	90	6,69	13,41	WGLIM146050
1460	600	50	570	615	314	600	570	1280	90	7,71	15,59	WGLIM146060
1460	700	50	670	706	360	800	670	1280	90	8,73	17,77	WGLIM146070
1700	300	50	270	369	188	400	270	1520	90	5,47	10,62	WGLIM170030
1700	400	50	370	492	251	600	370	1520	90	6,66	13,18	WGLIM170040
1700	500	50	470	615	313	600	470	1520	90	7,86	15,74	WGLIM170050
1700	600	50	570	722	368	800	570	1520	90	9,05	18,30	WGLIM170060
1700	700	50	670	828	422	800	670	1520	90	10,25	20,86	WGLIM170070

Verfügbare Größen:

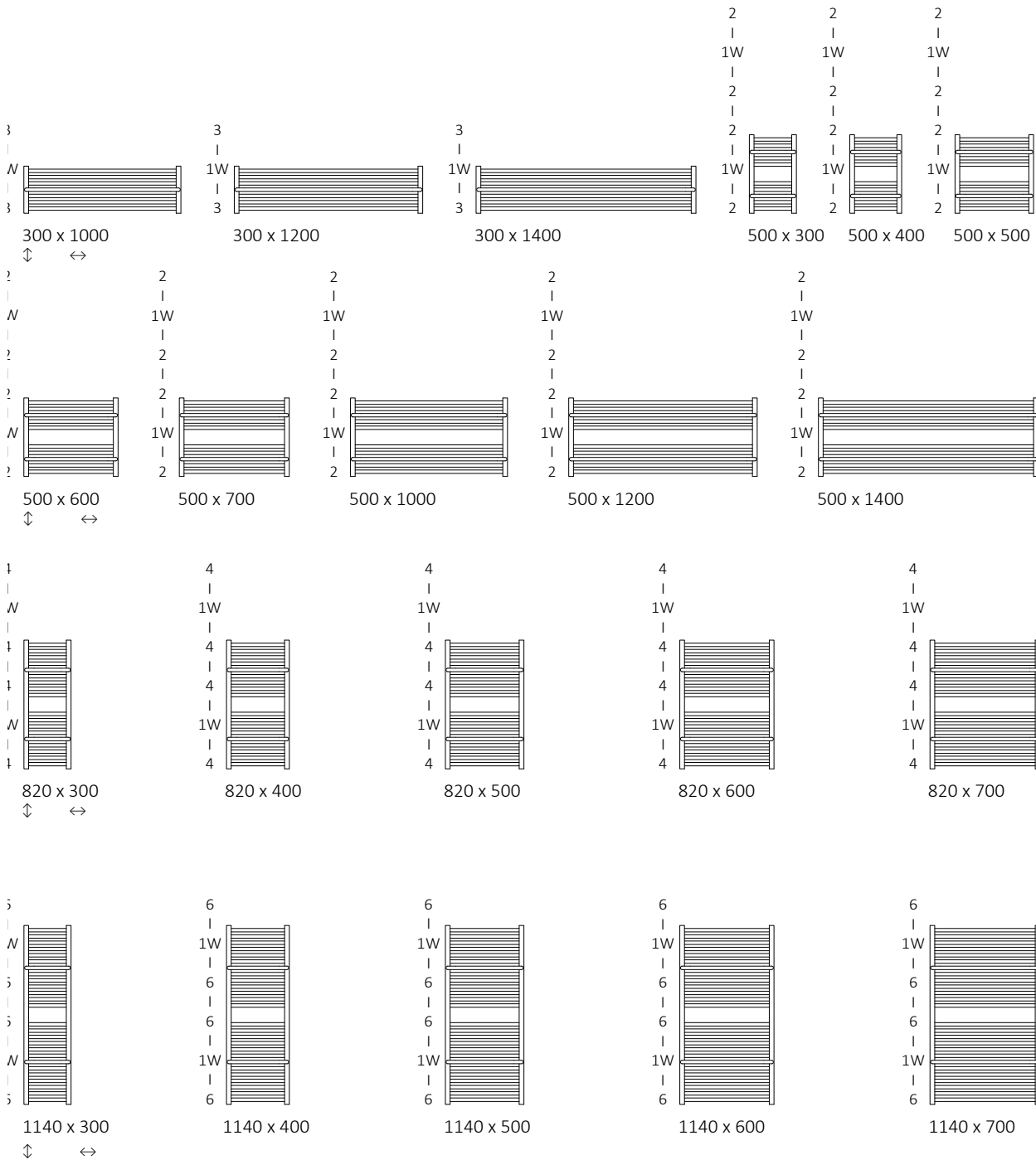

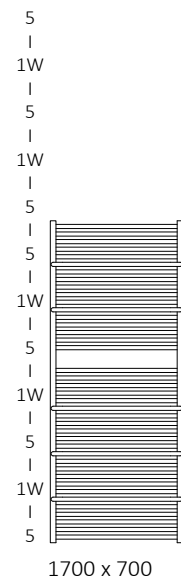
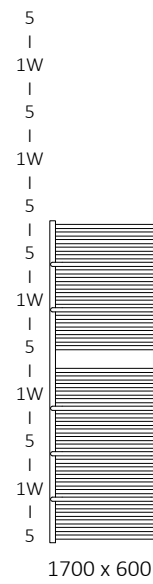
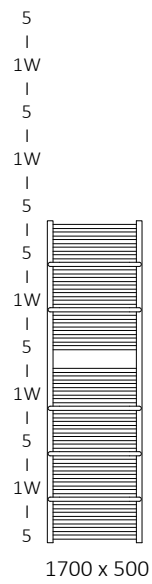
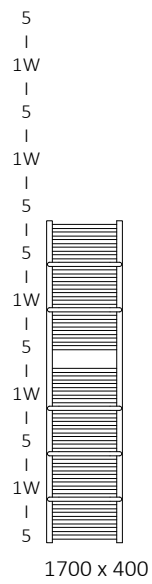
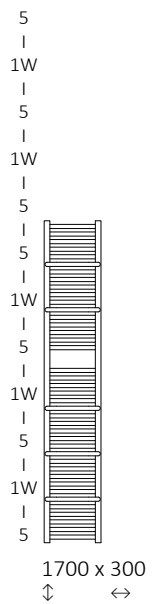
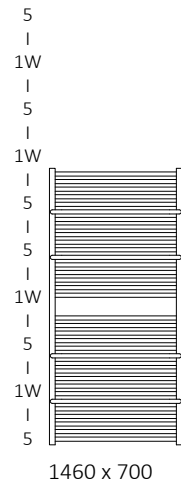
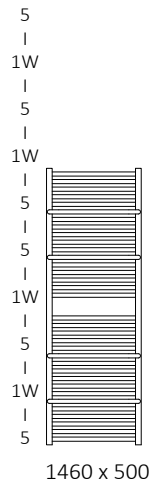
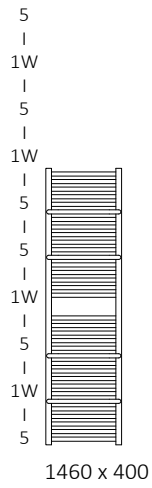
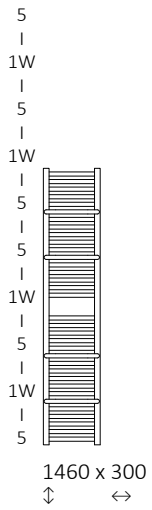

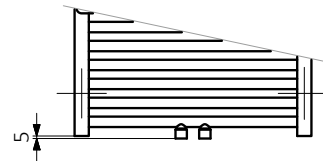
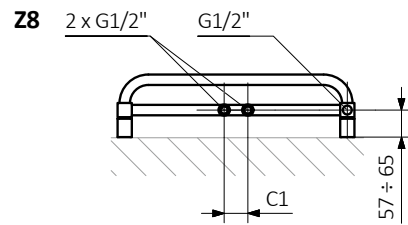
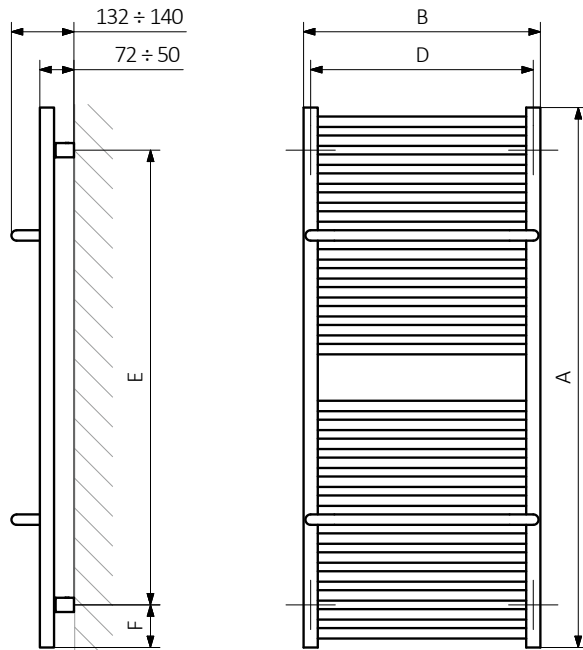
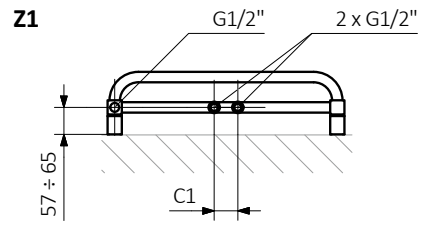
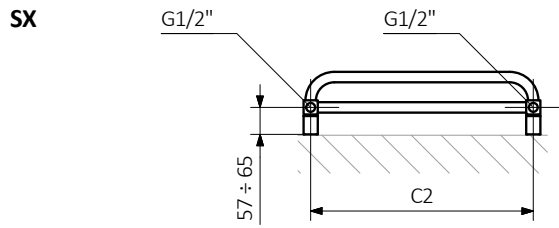

A – Höhe B – Breite C1-C5 – Anschlussabstand D – horizontaler Wandhalterungsabstand E – Vertikaler Wandhalterungsabstand F – Abstand von der Achse der unteren Wandhalterung bis Unterkante des Kollektors

Kollektor:

Rohr:

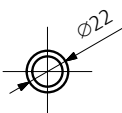
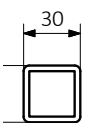

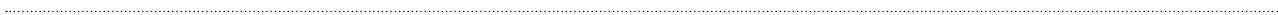



Standard Anschlussstypen:

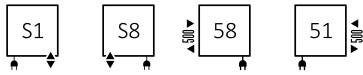

Weitere mögliche Anschlussstypen:

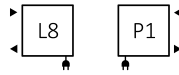

Elektroheizkörper siehe Seite 321

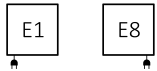

Technische Daten:

Betriebsdruck: 1000 kPa Maximale Betriebstemperatur: 82°C

A ↓ [mm]	B ↔ [mm]	C5 [mm]	75/65/20°C [W]	55/45/20°C [W]	☺ [W]	D [mm]	E [mm]	F [mm]	U [dm³]	⚖️ [kg]	Artikelnummer <small>(Konfigurations code s. 663)</small>
Pulverlack											
820	300	500	244	132	300	270	680	70	2,47	5,1	WZLIE082030
820	400	500	325	175	300	370	680	70	3,01	6,3	WZLIE082040
820	500	500	406	218	400	470	680	70	3,54	7,5	WZLIE082050
820	600	500	477	256	400	570	680	70	4,08	8,8	WZLIE082060
820	700	500	547	293	600	670	680	70	4,62	10,0	WZLIE082070
1140	300	500	345	185	400	270	1000	70	3,51	7,2	WZLIE114030
1140	400	500	460	247	400	370	1000	70	4,28	9,0	WZLIE114040
1140	500	500	574	308	600	470	1000	70	5,06	10,7	WZLIE114050
1140	600	500	675	361	800	570	1000	70	5,84	12,4	WZLIE114060
1140	700	500	776	415	800	670	1000	70	6,61	14,2	WZLIE114070
1460	300	500	449	240	400	270	1320	70	4,60	9,4	WZLIE146030
1460	400	500	599	319	600	370	1320	70	5,61	11,7	WZLIE146040
1460	500	500	748	399	800	470	1320	70	6,63	14,0	WZLIE146050
1460	600	500	879	468	800	570	1320	70	7,64	16,2	WZLIE146060
1460	700	500	1009	537	1000	670	1320	70	8,66	18,5	WZLIE146070
1700	300	500	527	280	600	270	1560	70	5,40	11,0	WZLIE170030
1700	400	500	703	374	800	370	1560	70	6,60	13,7	WZLIE170040
1700	500	500	878	466	800	470	1560	70	7,79	16,4	WZLIE170050
1700	600	500	1031	547	1000	570	1560	70	8,99	19,1	WZLIE170060

Wir empfehlen: Set Lanzen-Thermostat-Verbund-eckventil für Anschluss S1 und S8



Abdeckblende



Handtuchhalter
Yo!

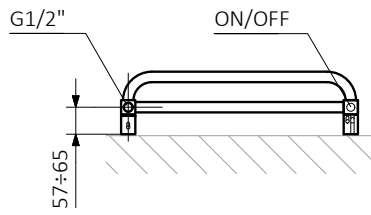
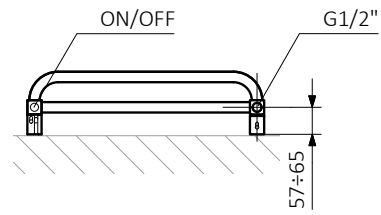
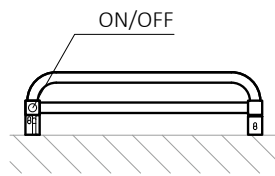
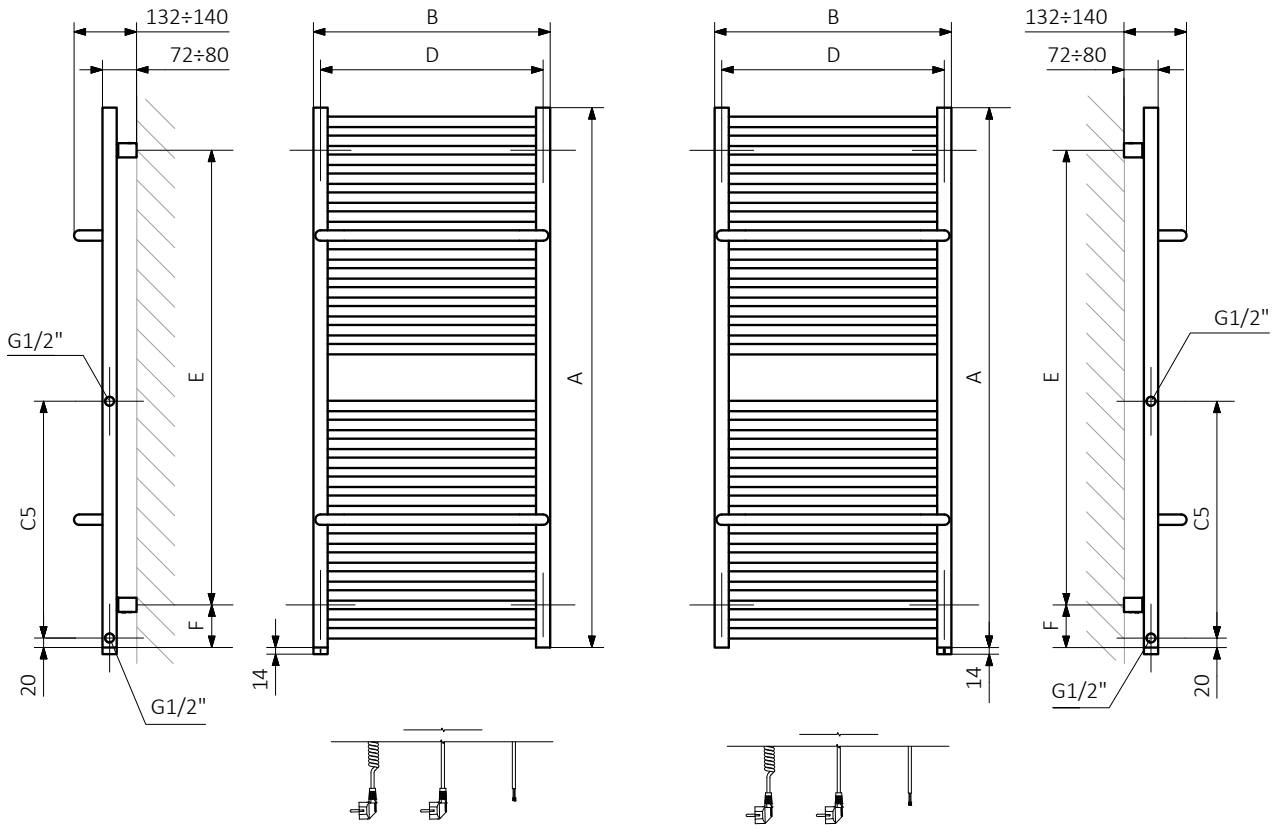
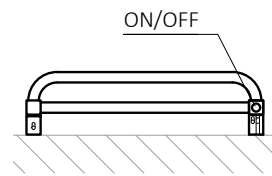

A ↓ [mm]	B ↔ [mm]	C5 [mm]	75/65/20°C [W]	55/45/20°C [W]	[W]	D [mm]	E [mm]	F [mm]	[dm²]	[kg]	Artikelnummer <small>(Konfigurationscode s. 663)</small>
Galvanische Oberfläche											
820	300	500	171	87	200	270	680	70	2,47	4,9	WZLIE082030
820	400	500	228	116	200	370	680	70	3,01	6,1	WZLIE082040
820	500	500	284	145	300	470	680	70	3,54	7,3	WZLIE082050
820	600	500	334	170	400	570	680	70	4,08	8,4	WZLIE082060
820	700	500	383	195	400	670	680	70	4,62	9,6	WZLIE082070
1140	300	500	242	123	300	270	1000	70	3,51	6,9	WZLIE114030
1140	400	500	322	164	300	370	1000	70	4,28	8,6	WZLIE114040
1140	500	500	402	205	400	470	1000	70	5,06	10,3	WZLIE114050
1140	600	500	473	241	400	570	1000	70	5,84	11,9	WZLIE114060
1140	700	500	543	277	600	670	1000	70	6,61	13,6	WZLIE114070
1460	300	500	314	160	300	270	1320	70	4,60	9,1	WZLIE146030
1460	400	500	419	214	400	370	1320	70	5,61	11,2	WZLIE146040
1460	500	500	524	267	600	470	1320	70	6,63	13,4	WZLIE146050
1460	600	500	615	314	600	570	1320	70	7,64	15,6	WZLIE146060
1460	700	500	706	360	800	670	1320	70	8,66	17,8	WZLIE146070
1700	300	500	369	188	400	270	1560	70	5,40	10,6	WZLIE170030
1700	400	500	492	251	600	370	1560	70	6,60	13,2	WZLIE170040
1700	500	500	615	313	600	470	1560	70	7,79	15,7	WZLIE170050
1700	600	500	722	368	800	570	1560	70	8,99	18,3	WZLIE170060
1700	700	500	828	422	800	670	1560	70	10,18	20,9	WZLIE170070

S8**S1****S1****S8**

A - Höhe B - Breite C1-C5 - Anschlussabstand D - horizontaler Wandhalterungsabstand E - Vertikaler Wandhalterungsabstand F - Abstand von der Achse der unteren Wandhalterung bis Unterkante des Kollektors

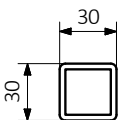
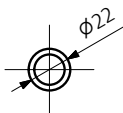
Kollektor:**Rohr:**



Standard Anschlussstypen:

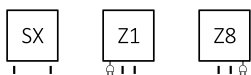

Elektroheizkörper siehe Seite 321

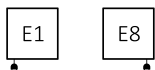

Weitere mögliche Anschlussstypen:

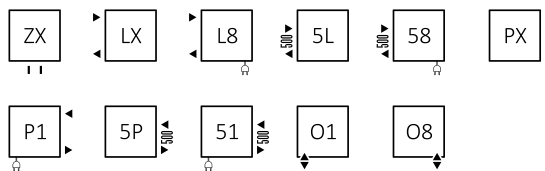

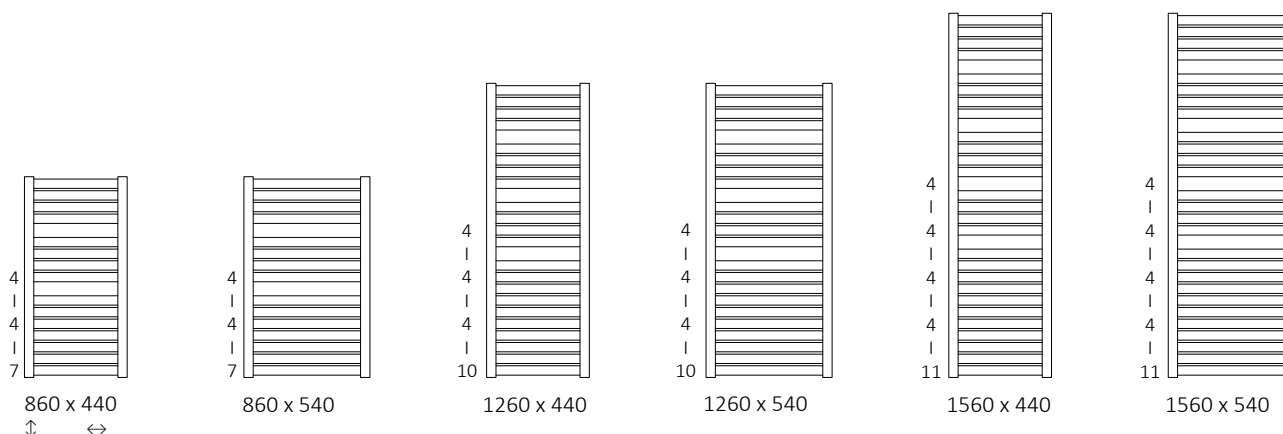

Verfügbare Größen:



Technische Daten:

Betriebsdruck: 800 kPa

Maximale Betriebstemperatur: 95°C

A ↓ [mm]	B ↔ [mm]	C1 [mm]	C2 [mm]	75/65 20°C [W]	55/45 20°C [W]	 [W]	D [mm]	E [mm]	F [mm]	 [dm ²]	 [kg]	Artikelnummer <small>(Konfigurations code s. 662)</small>
860	440	50	400	351	185	400	400	680	90	3,03	9,34	WGMAT086044
860	540	50	500	423	223	400	500	680	90	3,41	11,06	WGMAT086054
1260	440	50	400	502	266	600	400	1080	90	4,44	13,86	WGMAT126044
1260	540	50	500	605	319	600	500	1080	90	5,00	16,31	WGMAT126054
1560	440	50	400	615	326	600	400	1380	90	5,47	17,04	WGMAT156044
1560	540	50	500	742	391	800	500	1380	90	6,17	20,06	WGMAT156054

Wir empfehlen: Set Thermostat Verbunddeckventil für Anschluss Z1 und Z8



Abdeckblende



Heizpatronen Steuerung KTX 1



Handtuchhalter ZIP H 10



SX

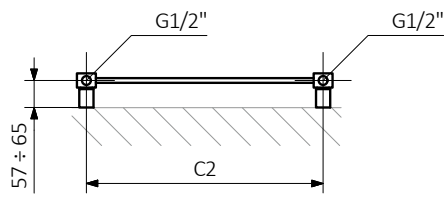

Z1

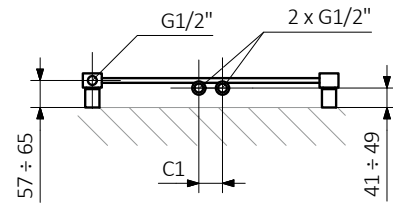

Z8

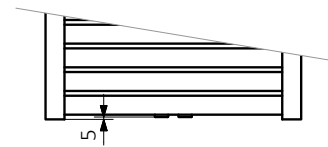
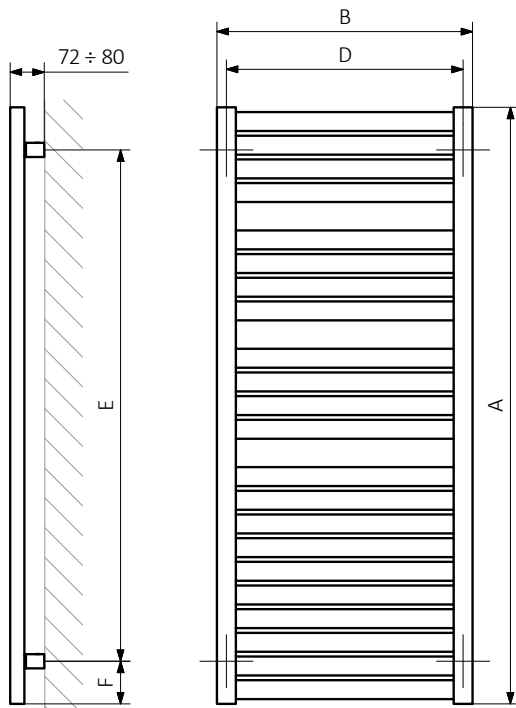
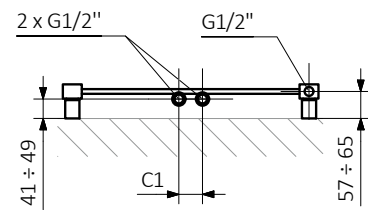

A - Höhe B - Breite C1-C5 - Anschlussabstand D - horizontaler Wandhalterungsabstand E - Vertikaler Wandhalterungsabstand F - Abstand von der Achse der unteren Wandhalterung bis Unterkante des Kollektors

Kollektor:

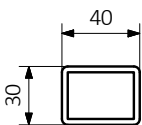

Rohr:

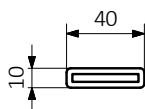



projekt: *Terma*

Standard Anschlussstypen:

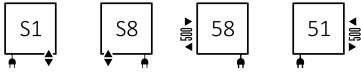

Elektroheizkörper siehe Seite 321

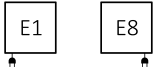

Weitere mögliche Anschlussstypen:

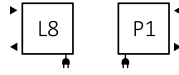

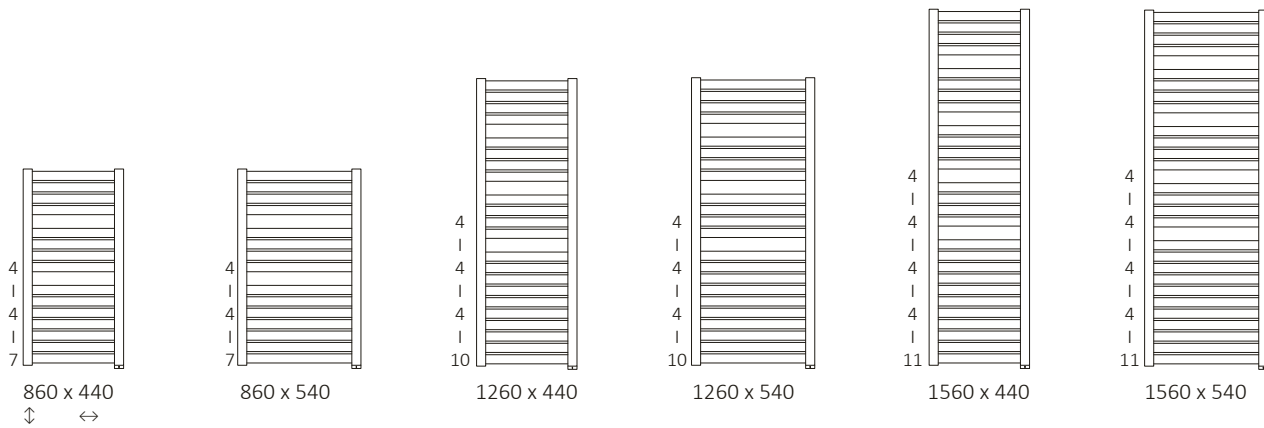

Verfügbare Größen:



Technische Daten:

Betriebsdruck: 800 kPa

Maximale Betriebstemperatur: 82°C

A ↓ [mm]	B ↔ [mm]	C5 [mm]	75 65 20°C [W]	55 45 20°C [W]	 [W]	D [mm]	E [mm]	F [mm]	 [dm ²]	 [kg]	Artikelnummer <small>(Konfigurations code s. 663)</small>
860	440	500	351	185	400	400	710	75	2,94	9,34	WZMAE086044
860	540	500	423	223	400	500	710	75	3,32	11,06	WZMAE086054
1260	440	500	502	266	600	400	1110	75	4,35	13,86	WZMAE126044
1260	540	500	605	319	600	500	1110	75	4,91	16,31	WZMAE126054
1560	440	500	615	326	600	400	1410	75	5,38	17,04	WZMAE156044
1560	540	500	742	391	800	500	1410	75	6,08	20,06	WZMAE156054

Wir empfehlen: Set Lanzen-Thermostat-Verbund-eckventil für Anschluss S1 und S8



Abdeckblende



Handtuchhalter

ZIP H 10

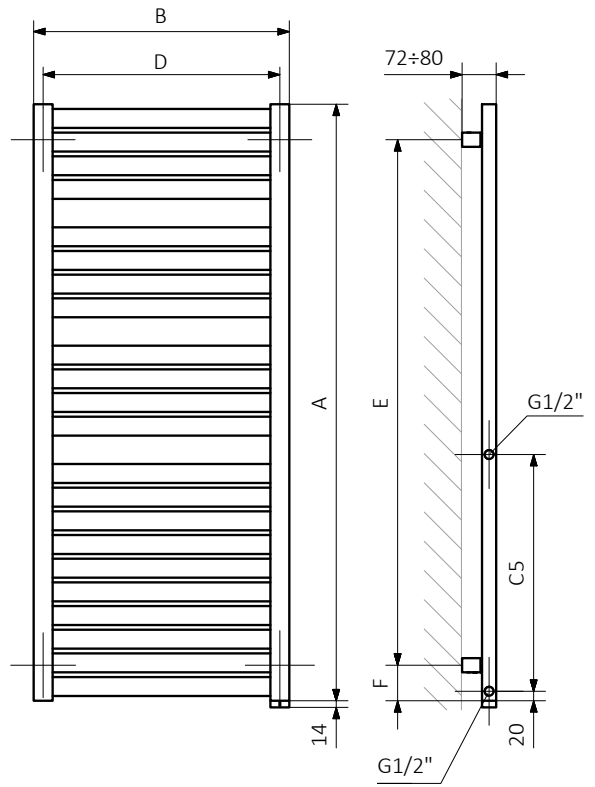
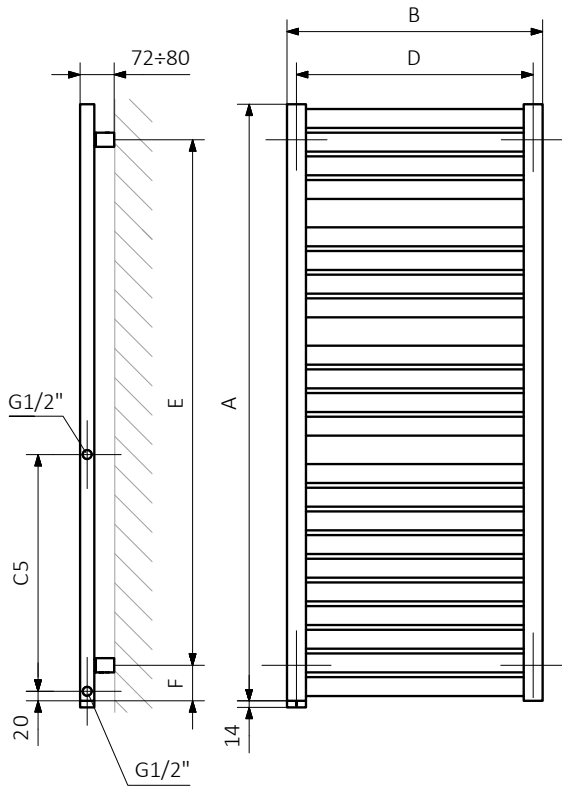
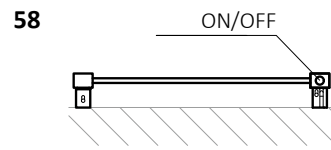
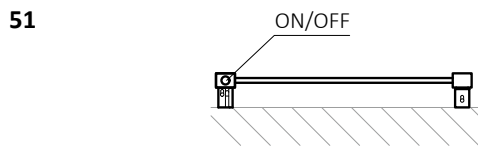
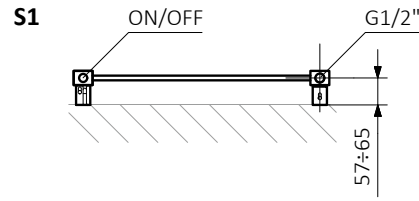
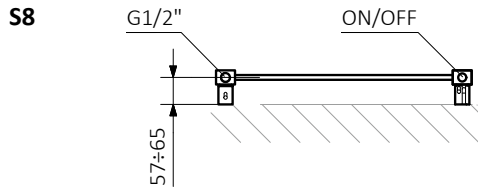

A - Höhe B - Breite C1-C5 - Anschlussabstand D - horizontaler Wandhalterungsabstand E - Vertikaler Wandhalterungsabstand F - Abstand von der Achse der unteren Wandhalterung bis Unterkante des Kollektors

Kollektor:

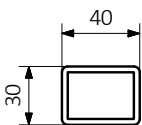

Rohr:

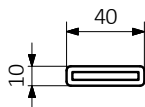



Standard Anschlussstypen:



Elektroheizkörper siehe Seite 321



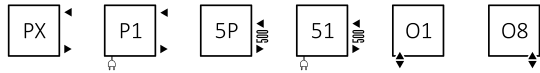
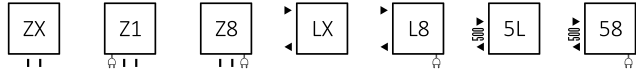

Weitere mögliche Anschlussstypen:



Technische Daten:

Betriebsdruck: 1000 kPa Maximale Betriebstemperatur: 95°C

A ↓ [mm]	B ↔ [mm]	C2 [mm]	75 65 20°C [W]	55 45 20°C [W]	 [W]	D [mm]	E [mm]	F [mm]	 [dm ²]	 [kg]	Artikelnummer <small>(Konfigurations code s. 662)</small>
Pulverlack											
600	430	400	244	134	300	400	420	90	1,57	5,03	WGMAR060043
600	530	500	301	165	300	500	420	90	1,76	5,92	WGMAR060053
600	630	600	358	196	400	600	420	90	1,94	6,81	WGMAR060063
780	430	400	319	172	300	400	600	90	2,11	6,84	WGMAR078043
780	530	500	393	212	400	500	600	90	2,38	8,08	WGMAR078053
780	630	600	467	252	400	600	600	90	2,64	9,32	WGMAR078063
1185	430	400	467	251	400	400	1005	90	3,25	10,52	WGMAR118043
1185	530	500	576	309	600	500	1005	90	3,66	12,48	WGMAR118053
1185	630	600	685	367	800	600	1005	90	4,08	14,43	WGMAR118063
1680	430	400	653	351	600	400	1500	90	4,66	15,12	WGMAR168043
1680	530	500	805	433	800	500	1500	90	5,27	17,97	WGMAR168053
1680	630	600	957	514	1000	600	1500	90	5,87	20,81	WGMAR168063
Galvanische Oberfläche											
600	430	400	156	84	120	400	420	90	1,57	4,86	WGMAR060043
600	530	500	192	104	200	500	420	90	1,76	5,71	WGMAR060053
600	630	600	228	124	200	600	420	90	1,94	6,57	WGMAR060063
780	430	400	211	112	200	400	600	90	2,11	6,60	WGMAR078043
780	530	500	260	137	300	500	600	90	2,38	7,80	WGMAR078053
780	630	600	310	163	300	600	600	90	2,64	9,00	WGMAR078063
1185	430	400	323	162	300	400	1005	90	3,25	10,16	WGMAR118043
1185	530	500	398	199	400	500	1005	90	3,66	12,05	WGMAR118053
1185	630	600	473	237	600	600	1005	90	4,08	13,93	WGMAR118063
1680	430	400	462	217	600	400	1500	90	4,66	14,60	WGMAR168043
1680	530	500	570	267	600	500	1500	90	5,27	17,35	WGMAR168053
1680	630	600	677	317	800	600	1500	90	5,87	20,09	WGMAR168063

Wir empfehlen: Set Winkeck-Thermostat-ventil für Anschluss SX



Set einteilige Blende



Heizpatrone REG 3



Handtuchhalter ZIP H 10



Verfügbare Größen:

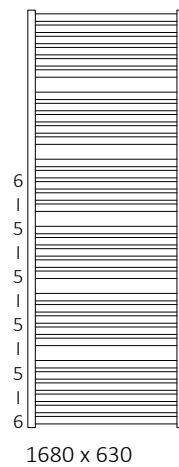
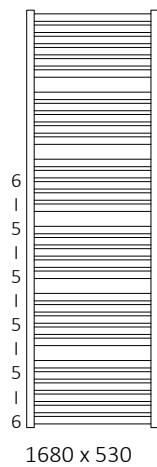
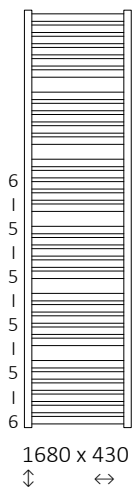
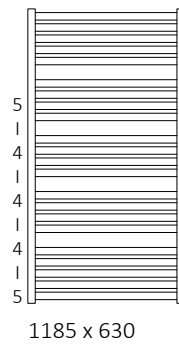
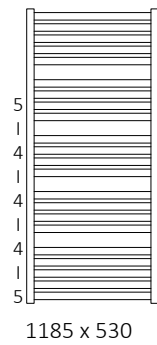
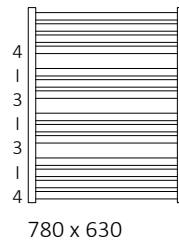
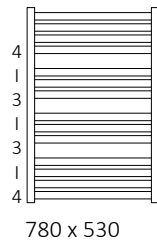
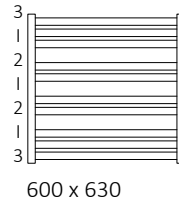
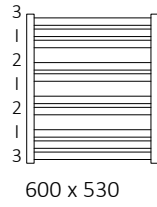
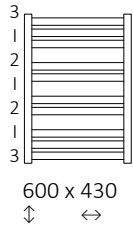

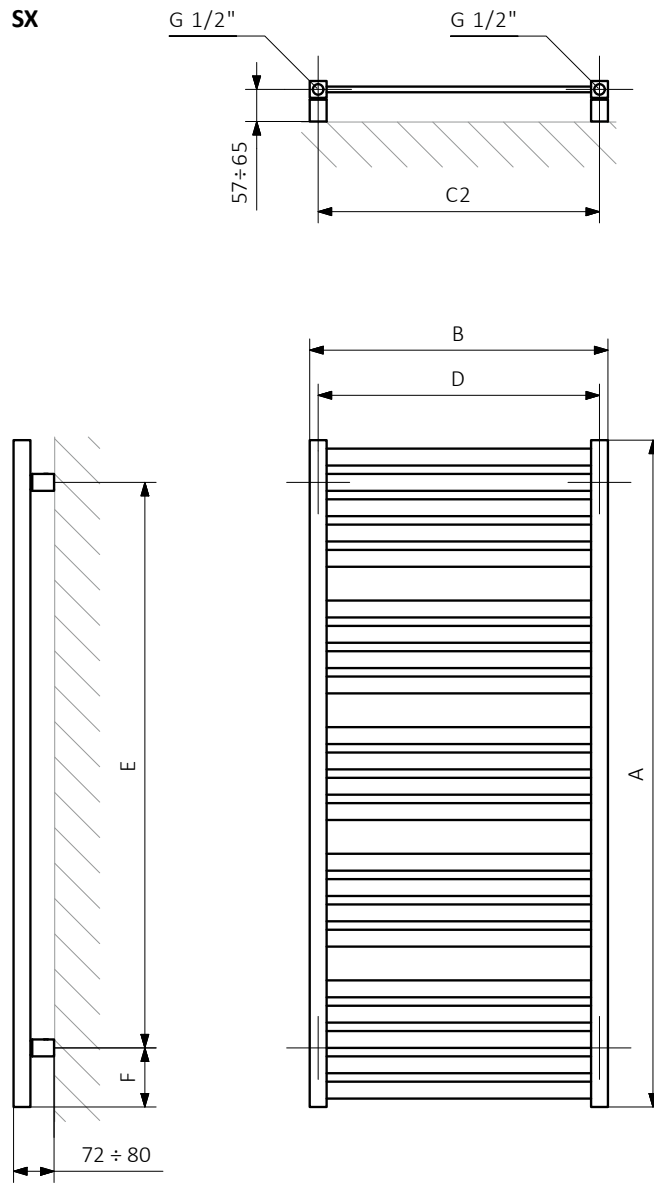

A – Höhe B – Breite C1-C5 – Anschlussabstand D – horizontaler Wandhalterungsabstand E – Vertikaler Wandhalterungsabstand
 F – Abstand von der Achse der unteren Wandhalterung bis Unterkante des Kollektors

Kollektor:

Rohr:

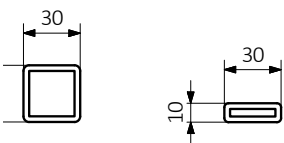





Standard Anschlussstypen:

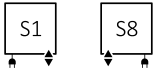

Elektroheizkörper siehe Seite 321

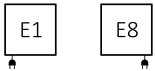

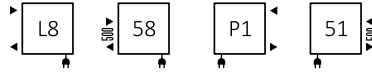

Weitere mögliche Anschlussstypen:



Technische Daten:

Betriebsdruck: 1000 kPa Maximale Betriebstemperatur: 82°C

A ↓ [mm]	B ↔ [mm]	75/65/20°C [W]	55/45/20°C [W]	 [W]	D [mm]	E [mm]	F [mm]	 [dm³]	 [kg]	Artikelnummer <small>(Konfigurations code s. 663)</small>
Pulverlack										
600	430	244	134	300	400	450	75	1,50	5,01	WZMRN060043
600	530	301	165	300	500	450	75	1,69	5,91	WZMRN060053
600	630	358	196	400	600	450	75	1,88	6,82	WZMRN060063
780	430	319	172	300	400	630	75	2,05	6,85	WZMRN078043
780	530	393	212	400	500	630	75	2,32	8,11	WZMRN078053
780	630	467	252	400	600	630	75	2,58	9,37	WZMRN078063
1185	430	467	251	400	400	1035	75	3,19	10,57	WZMRN118043
1185	530	576	309	600	500	1035	75	3,61	12,54	WZMRN118053
1185	630	685	367	800	600	1035	75	4,02	14,51	WZMRN118063
1680	430	653	351	600	400	1530	75	4,61	15,19	WZMRN168043
1680	530	805	433	800	500	1530	75	5,22	18,05	WZMRN168053
1680	630	957	514	1000	600	1530	75	5,82	20,91	WZMRN168063
Galvanische Oberfläche										
600	430	156	84	120	400	450	75	1,50	4,83	WZMRN060043
600	530	192	104	200	500	450	75	1,69	5,71	WZMRN060053
600	630	228	124	200	600	450	75	1,88	6,58	WZMRN060063
780	430	211	112	200	400	630	75	2,05	6,61	WZMRN078043
780	530	260	137	300	500	630	75	2,32	7,83	WZMRN078053
780	630	310	163	300	600	630	75	2,58	9,05	WZMRN078063
1185	430	323	162	300	400	1035	75	3,19	10,21	WZMRN118043
1185	530	398	199	400	500	1035	75	3,61	12,11	WZMRN118053
1185	630	473	237	600	600	1035	75	4,02	14,01	WZMRN118063
1680	430	462	217	600	400	1530	75	4,61	14,67	WZMRN168043
1680	530	570	267	600	500	1530	75	5,22	17,43	WZMRN168053
1680	630	677	317	800	600	1530	75	5,82	20,19	WZMRN168063

Wir empfehlen: Set Lanzen-Thermostat-Verbund-eckventil für Anschluss S1 und S8



Abdeckblende



Handtuchhalter
ZIP H 10



Verfügbare Größen:

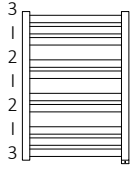

600 x 430
↕ ↔

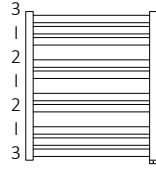

600 x 530

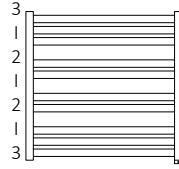

600 x 630

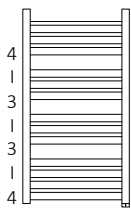

780 x 430

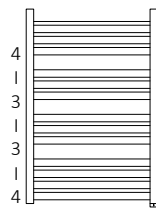

780 x 530

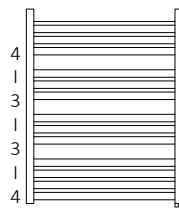

780 x 630

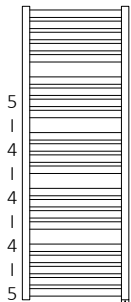

1185 x 430
↕ ↔

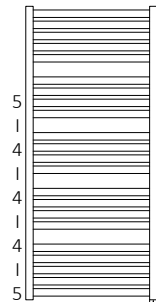

1185 x 530

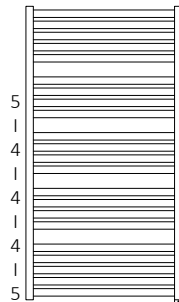

1185 x 630

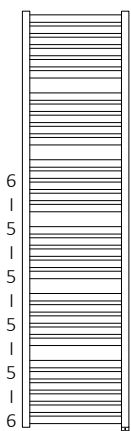

1680 x 430
↕ ↔

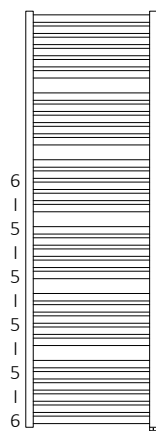

1680 x 530

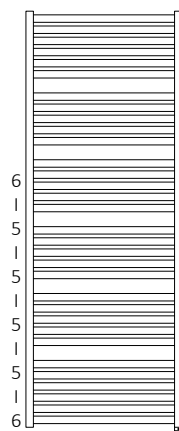

1680 x 630

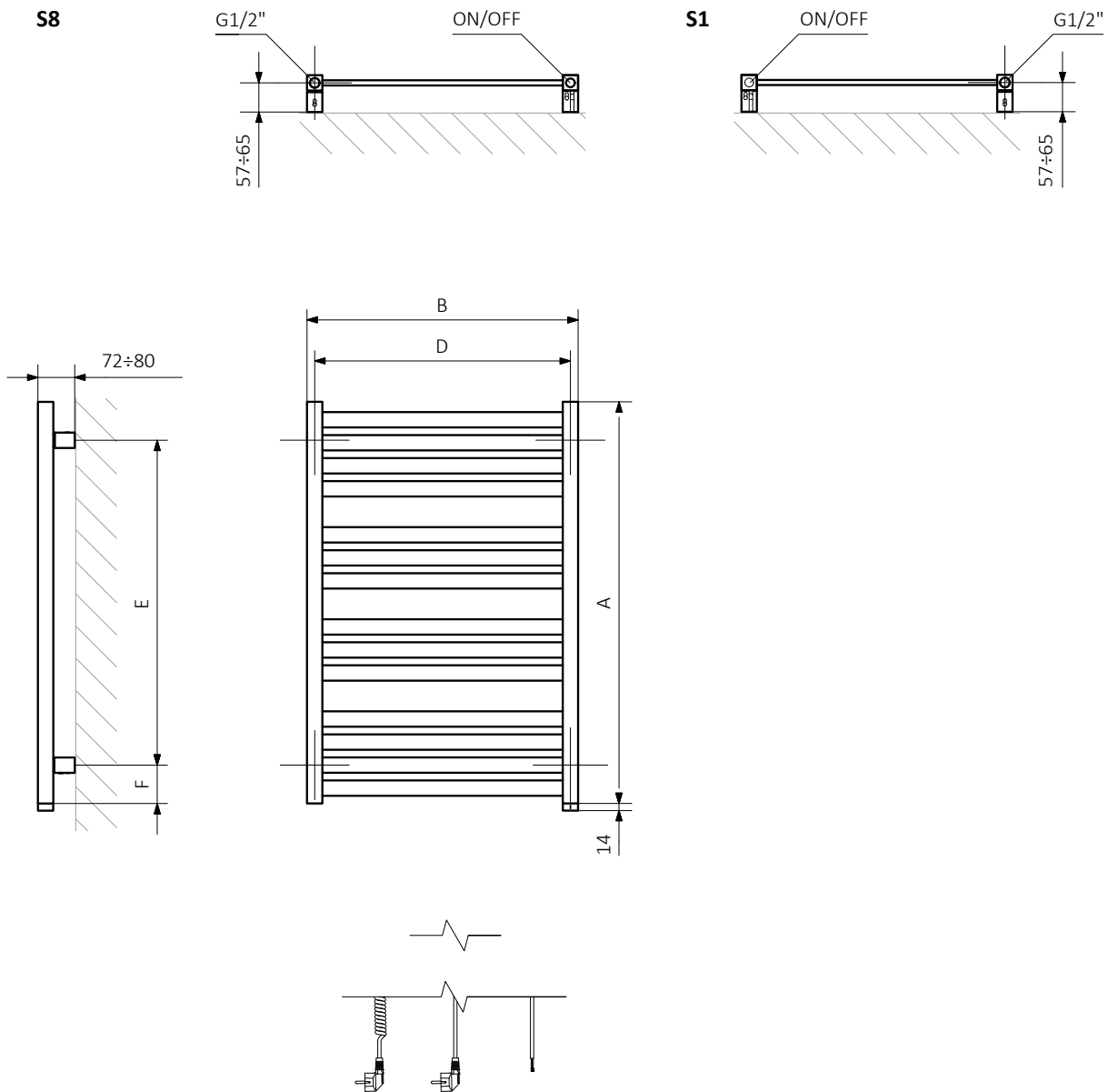

A – Höhe B – Breite C1-C5 – Anschlussabstand D – horizontaler Wandhalterungsabstand E – Vertikaler Wandhalterungsabstand F – Abstand von der Achse der unteren Wandhalterung bis Unterkante des Kollektors

Kollektor:

Rohr:

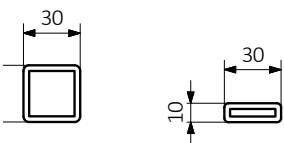





Standard Anschlussstypen:

Elektroheizkörper siehe Seite 321



Verfügbare Größen:

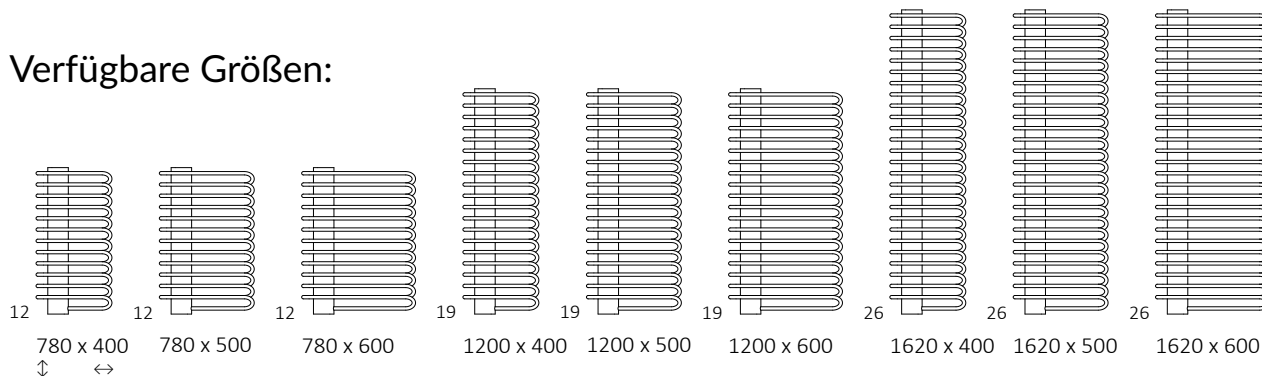

Technische Daten:

Betriebsdruck: 1000 kPa Maximale Betriebstemperatur: 95°C

A ↓ [mm]	B ↔ [mm]	C1 [mm]	75/65/20°C [W]	55/45/20°C [W]	☉ [W]	D [mm]	E [mm]	F [mm]	H [dm ²]	G [kg]	Artikelnummer <small>(Konfigurations code s. 662)</small>
-------------	-------------	------------	-------------------	-------------------	----------	-----------	-----------	-----------	-------------------------	-----------	--

Pulverlack

780	400	50	365	196	400	50	600	90	2,84	11,51	WGMIC078040
780	500	50	455	244	400	50	600	90	3,29	12,80	WGMIC078050
780	600	50	533	286	600	50	600	90	3,75	14,10	WGMIC078060
1200	400	50	580	310	600	50	1020	90	4,46	18,03	WGMIC120040
1200	500	50	721	386	800	50	1020	90	5,18	20,07	WGMIC120050
1200	600	50	845	452	800	50	1020	90	5,90	22,13	WGMIC120060
1620	400	50	805	429	800	50	1440	90	6,10	24,59	WGMIC162040
1620	500	50	1000	533	1000	50	1440	90	7,08	27,40	WGMIC162050
1620	600	50	1172	624	1200	50	1440	90	8,06	30,20	WGMIC162060

Galvanische Oberfläche

780	400	50	256	130	300	50	600	90	2,84	11,23	WGMIC078040
780	500	50	319	162	300	50	600	90	3,29	12,47	WGMIC078050
780	600	50	373	190	400	50	600	90	3,75	13,71	WGMIC078060
1200	400	50	406	207	400	50	1020	90	4,46	17,59	WGMIC120040
1200	500	50	505	257	600	50	1020	90	5,18	19,55	WGMIC120050
1200	600	50	592	302	600	50	1020	90	5,90	21,52	WGMIC120060
1620	400	50	564	287	600	50	1440	90	6,10	23,99	WGMIC162040
1620	500	50	700	357	800	50	1440	90	7,08	26,68	WGMIC162050
1620	600	50	820	418	800	50	1440	90	8,06	29,37	WGMIC162060

Es besteht die Möglichkeit für die Blende eine andere Farbe zu wählen als für den Heizkörper.

Wir empfehlen: Set Thermostat Verbunddeckventil mit Anschlussmöglichkeit für eine Heizpatrone für Anschluss YL und YP



Abdeckblende



Heizpatrone
MOA IR



YL

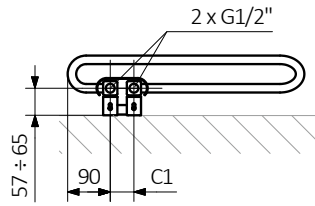

YP

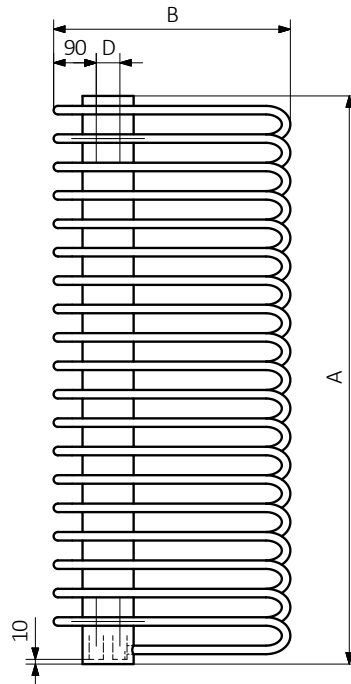
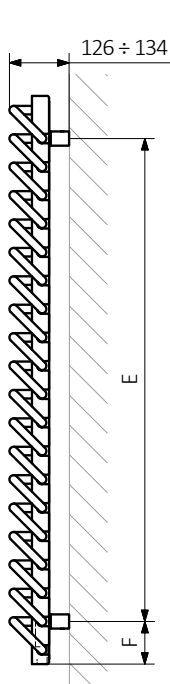
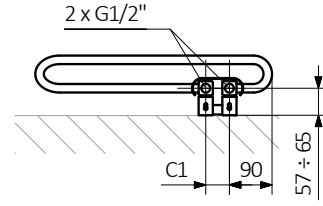

A - Höhe B - Breite C1-C5 - Anschlussabstand D - horizontaler Wandhalterungsabstand E - Vertikaler Wandhalterungsabstand F - Abstand von der Achse der unteren Wandhalterung bis Unterkante des Kollektors

Kollektor:

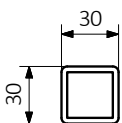

Rohr:

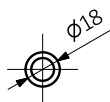



Standard Anschlussstypen:

A \updownarrow 435÷1635, B \leftrightarrow 230÷530:



Elektroheizkörper siehe Seite 321



Weitere mögliche Anschlussstypen:

A \updownarrow 435÷1635, B \leftrightarrow 230÷530:

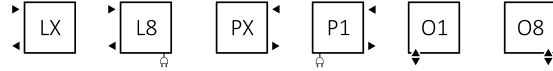

A \updownarrow 435÷1635, B \leftrightarrow 430÷530:

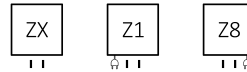

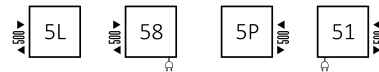

A \updownarrow 735÷1635, B \leftrightarrow 230÷530:



Technische Daten:

Betriebsdruck: 1000 kPa

Maximale Betriebstemperatur: 95°C

A \updownarrow [mm]	B \leftrightarrow [mm]	C2 [mm]	75 65 20°C [W]	55 45 20°C [W]	 [W]	D [mm]	E [mm]	F [mm]	 [dm ³]	 [kg]	Artikelnummer <small>(Konfigurations code s. 662)</small>
Pulverlack											
435	430	400	203	106	200	400	255	90	1,25	3,62	WGMIK043043
435	530	500	245	128	300	500	255	90	1,41	4,28	WGMIK043053
460	230	200	122	64	120	200	280	90	0,92	2,24	WGMIK046023
710	230	200	185	97	200	200	530	90	1,40	3,38	WGMIK071023
735	430	400	337	176	400	400	555	90	2,07	5,92	WGMIK073043
735	530	500	406	213	400	500	555	90	2,34	6,99	WGMIK073053
960	230	200	247	130	300	200	780	90	1,89	4,52	WGMIK096023
1035	430	400	466	245	400	400	855	90	2,89	8,21	WGMIK103043
1035	530	500	563	295	600	500	855	90	3,26	9,69	WGMIK103053
1210	230	200	308	162	300	200	1030	90	2,38	5,66	WGMIK121023
1335	430	400	593	312	600	400	1155	90	3,71	10,51	WGMIK133043
1335	530	500	715	376	800	500	1155	90	4,19	12,40	WGMIK133053
1460	230	200	367	193	400	200	1280	90	2,86	6,80	WGMIK146023
1635	430	400	716	377	800	400	1455	90	4,53	12,81	WGMIK163043
1635	530	500	864	454	800	500	1455	90	5,11	15,11	WGMIK163053
1710	230	200	425	224	400	200	1530	90	3,35	7,94	WGMIK171023

Wir empfehlen: Set Winkeleck-Regelventil für Anschluss SX



Set einteilige Blende



Heizpatrone ONE



A ↓ [mm]	B ↔ [mm]	C2 [mm]	75/65/20°C [W]	55/45/20°C [W]	☺ [W]	D [mm]	E [mm]	F [mm]	📄 [dm ²]	📦 [kg]	Artikelnummer <small>(Konfigurations code s. 662)</small>
Galvanische Oberfläche											
435	430	400	142	72	120	400	255	90	1,25	3,48	WGMIK043043
435	530	500	171	87	200	500	255	90	1,41	4,11	WGMIK043053
460	230	200	85	44	120	200	280	90	0,92	2,16	WGMIK046023
710	230	200	130	66	120	200	530	90	1,40	3,25	WGMIK071023
735	430	400	236	120	200	400	555	90	2,07	5,68	WGMIK073043
735	530	500	284	145	300	500	555	90	2,34	6,71	WGMIK073053
960	230	200	173	88	200	200	780	90	1,89	4,35	WGMIK096023
1035	430	400	326	167	300	400	855	90	2,89	7,89	WGMIK103043
1035	530	500	394	201	400	500	855	90	3,26	9,31	WGMIK103053
1210	230	200	216	110	200	200	1030	90	2,38	5,45	WGMIK121023
1335	430	400	415	212	400	400	1155	90	3,71	10,09	WGMIK133043
1335	530	500	501	255	600	500	1155	90	4,19	11,90	WGMIK133053
1460	230	200	257	131	300	200	1280	90	2,86	6,54	WGMIK146023
1635	430	400	501	256	600	400	1455	90	4,53	12,30	WGMIK163043
1635	530	500	605	308	600	500	1455	90	5,11	14,50	WGMIK163053
1710	230	200	298	152	300	200	1530	90	3,35	7,64	WGMIK171023

Verfügbare Größen:

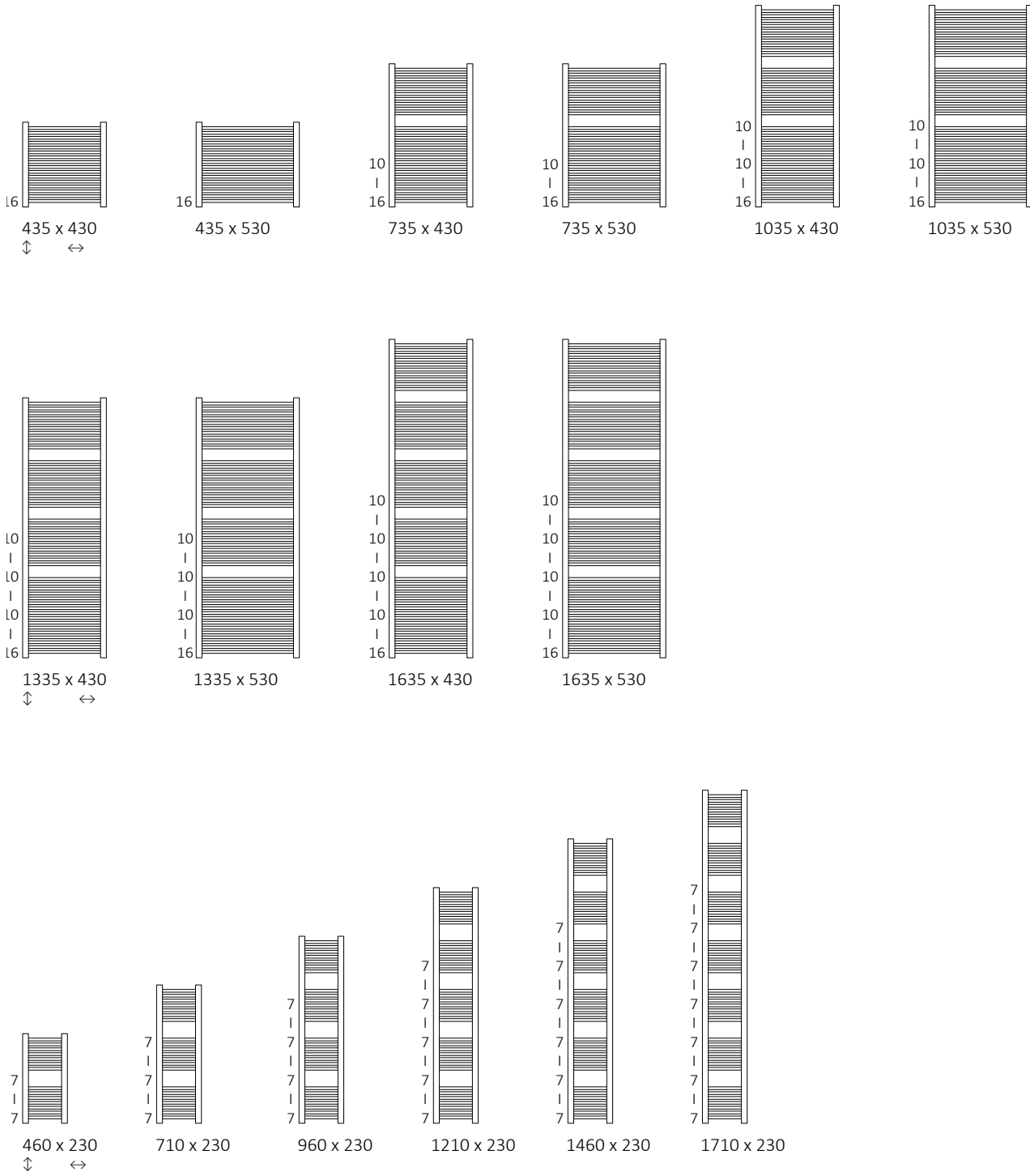

SX

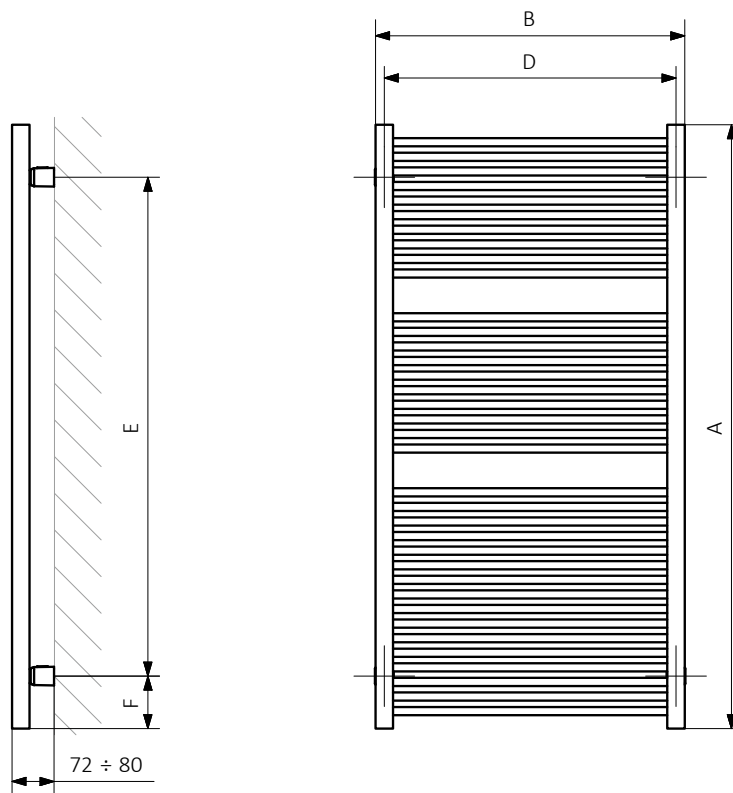
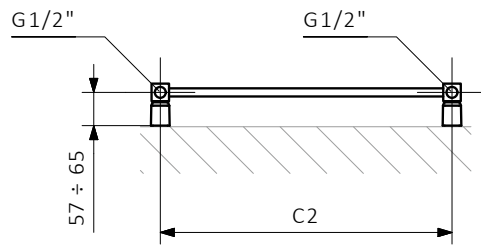

A - Höhe B - Breite C1-C5 - Anschlussabstand D - horizontaler Wandhalterungsabstand E - Vertikaler Wandhalterungsabstand F - Abstand von der Achse der unteren Wandhalterung bis Unterkante des Kollektors

Kollektor:

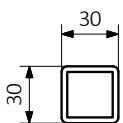

Rohr:

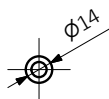



Standard Anschlussstypen:

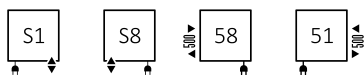

Weitere mögliche Anschlussstypen:

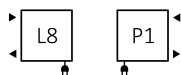

Elektroheizkörper siehe Seite 321

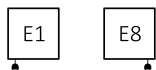

Technische Daten:

Betriebsdruck: 1000 kPa Maximale Betriebstemperatur: 82°C

A ↓ [mm]	B ↔ [mm]	C5 [mm]	75/65/20°C [W]	55/45/20°C [W]	 [W]	D [mm]	E [mm]	F [mm]	 [dm²]	 [kg]	Artikelnummer <small>(Konfigurations code s. 663)</small>
Pulverlack											
710	230	-	185	97	200	200	570	70	1,34	3,38	WZMIN071023
735	430	500	337	176	400	400	595	70	2,00	5,92	WZMIN073043
735	530	500	406	213	400	500	595	70	2,27	6,99	WZMIN073053
960	230	-	247	130	300	200	820	70	1,82	4,52	WZMIN096023
1035	430	500	466	245	400	400	895	70	2,82	8,21	WZMIN103043
1035	530	500	563	295	600	500	895	70	3,20	9,69	WZMIN103053
1210	230	-	308	162	300	200	1170	70	2,31	5,66	WZMIN121023
1335	430	500	593	312	600	400	1195	70	3,64	10,51	WZMIN133043
1335	530	500	715	376	800	500	1195	70	4,12	12,40	WZMIN133053
1460	230	-	367	193	400	200	1320	70	2,80	6,80	WZMIN146023
1635	430	500	716	377	800	400	1495	70	4,46	12,81	WZMIN163043
1635	530	500	864	454	800	500	1495	70	5,05	15,11	WZMIN163053
1710	230	-	425	224	400	200	1570	70	3,29	7,94	WZMIN171023
Galvanische Oberfläche											
710	230	-	130	66	120	200	570	70	1,34	3,25	WZMIN071023
735	430	500	236	120	200	400	595	70	2,00	5,68	WZMIN073043
735	530	500	284	145	300	500	595	70	2,27	6,71	WZMIN073053
960	230	-	173	88	200	200	820	70	1,82	4,35	WZMIN096023
1035	430	500	326	167	300	400	895	70	2,82	7,89	WZMIN103043
1035	530	500	394	201	400	500	895	70	3,20	9,31	WZMIN103053
1210	230	-	216	110	200	200	1070	70	2,31	5,45	WZMIN121023
1335	430	500	415	212	400	400	1195	70	3,64	10,09	WZMIN133043
1335	530	500	501	255	600	500	1195	70	4,12	11,9	WZMIN133053
1460	230	-	257	131	300	200	1320	70	2,80	6,54	WZMIN146023
1635	430	500	501	256	600	400	1495	70	4,46	12,3	WZMIN163043
1635	530	500	605	308	600	500	1495	70	5,05	14,5	WZMIN163053
1710	230	-	298	152	300	200	1570	70	3,29	7,64	WZMIN171023

Wir empfehlen: Set Lanzen-Thermostat-Verbunddeckventil für Anschluss S1 und S8

Abdeckblende



Verfügbare Größen:

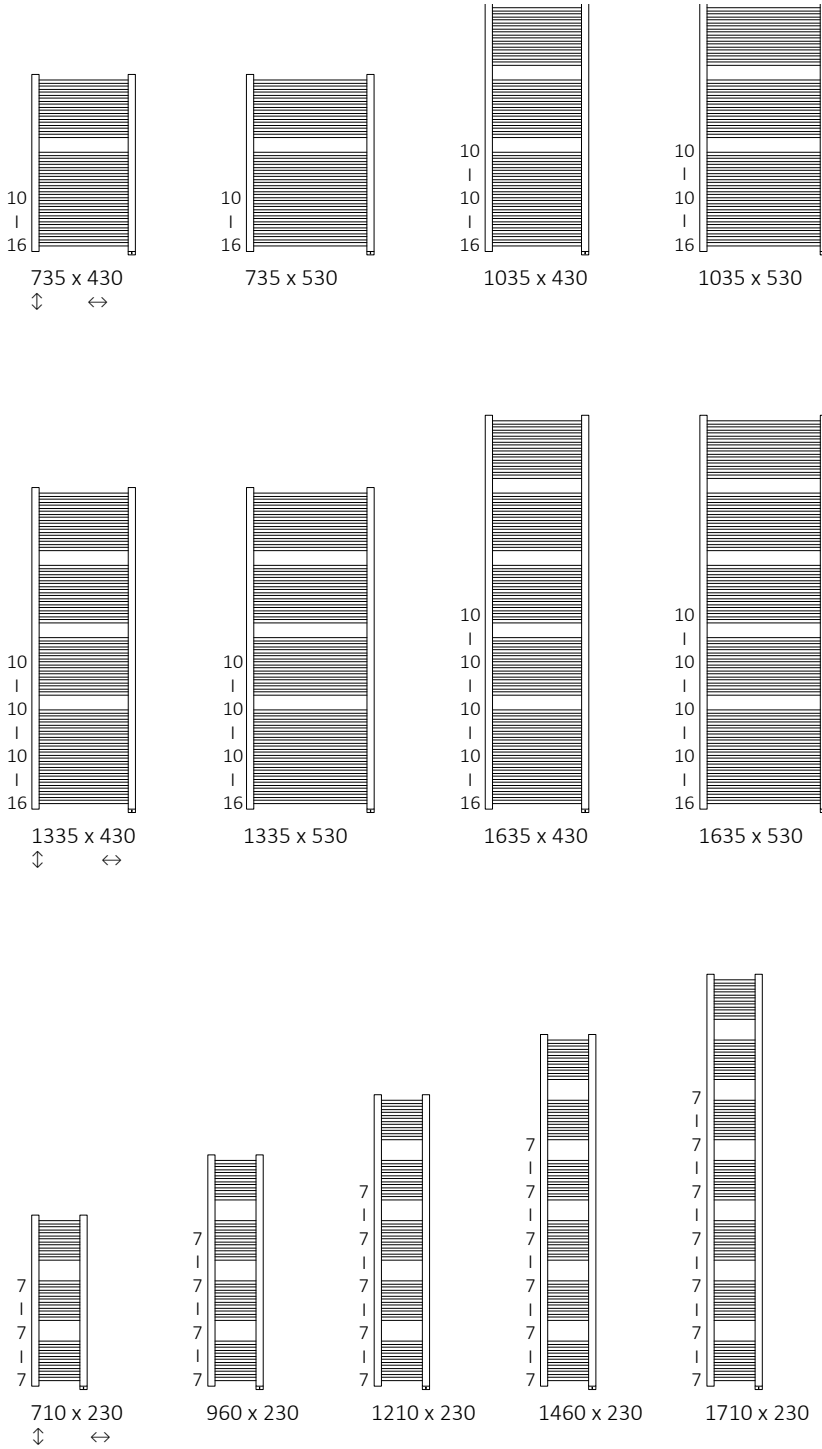

S8

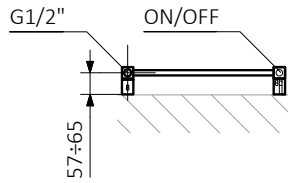

S1

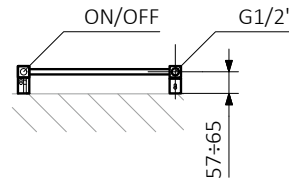

S1

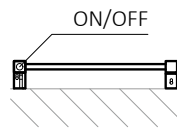

S8

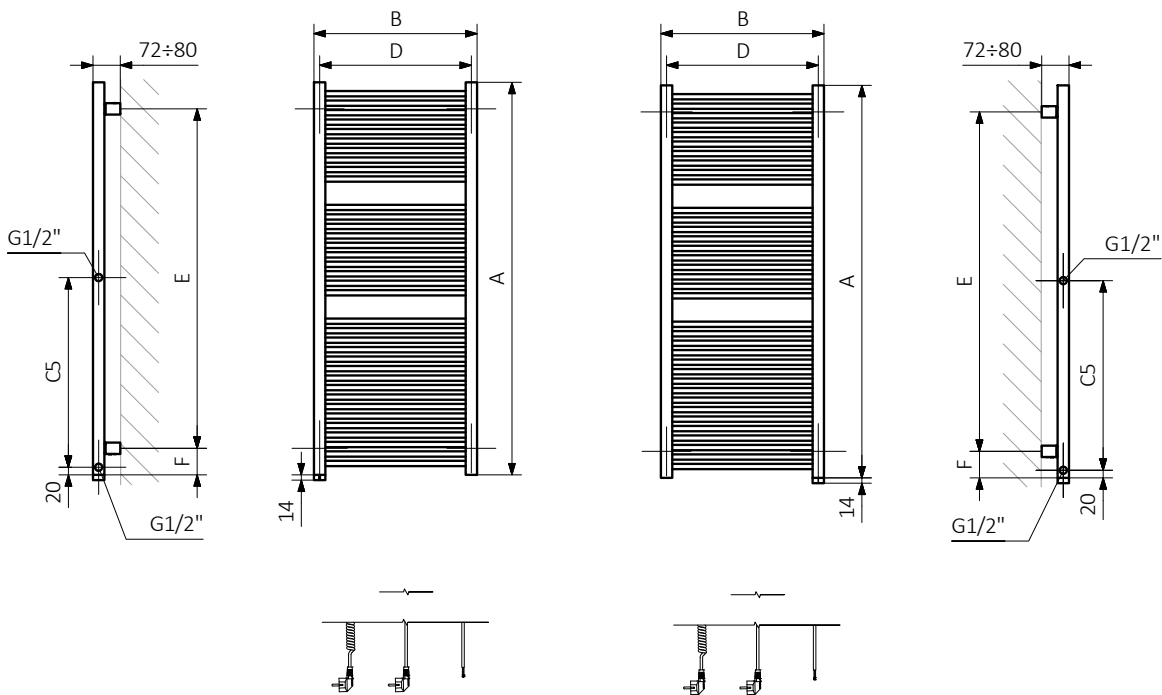
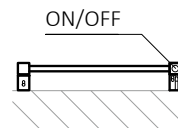

A - Höhe B - Breite C1-C5 - Anschlussabstand D - horizontaler Wandhalterungsabstand E - Vertikaler Wandhalterungsabstand F - Abstand von der Achse der unteren Wandhalterung bis Unterkante des Kollektors

Kollektor:

Rohr:

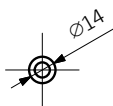
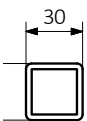

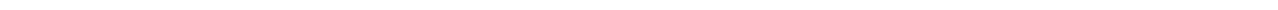



Standard Anschlussstypen:

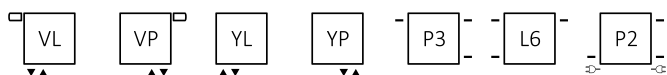

Elektroheizkörper siehe Seite 321



Technische Daten:

Betriebsdruck: 1000 kPa

Maximale Betriebstemperatur: 95°C

A ↓ [mm]	B ↔ [mm]	C1 [mm]	C3 [mm]	75/65/20°C [W]	55/45/20°C [W]	☉ [W]	D [mm]	E [mm]	F [mm]	☪ [dm³]	📖 [kg]	Artikelnummer <small>(Konfigurations code s. 662)</small>
300	645	50	270	375	199	400	495	270	15	2,42	8,72	WGNEM030064
300	915	50	270	533	282	600	765	270	15	3,45	12,42	WGNEM030091
300	1185	50	270	690	365	800	1035	270	15	4,48	16,13	WGNEM030118
300	1455	50	270	847	448	800	1305	270	15	5,51	19,83	WGNEM030145
300	1725	50	270	1004	532	1000	1575	270	15	6,54	23,55	WGNEM030172
530	375	50	500	364	190	400	225	500	15	2,09	8,34	WGNEM053037
530	645	50	500	626	327	600	495	500	15	3,64	14,50	WGNEM053064
530	915	50	500	888	464	800	765	500	15	5,19	20,67	WGNEM053091
530	1185	50	500	1150	600	1200	1035	500	15	6,74	26,85	WGNEM053118
530	1455	50	500	1412	737	1500	1305	500	15	8,29	33,03	WGNEM053145
530	1725	50	500	1675	875	1500	1575	500	15	9,84	39,22	WGNEM053172

Wir empfehlen: Set Absperr-Verbunddeckventil
für Anschluss VL, VP, V3 und V6



Abdeckblende



Verfügbare Größen:

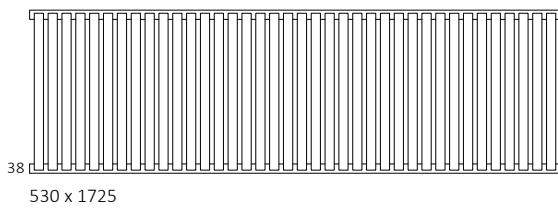
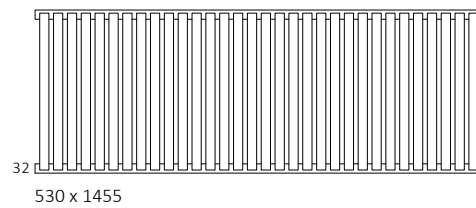
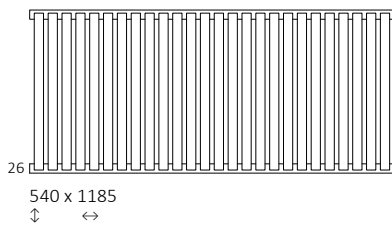
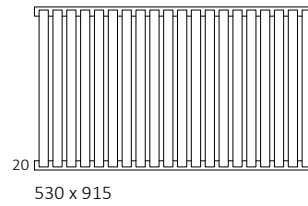
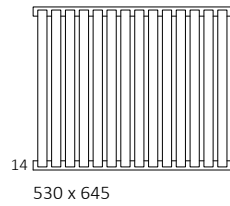
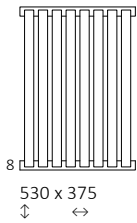
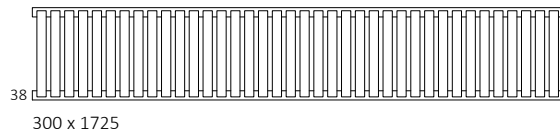
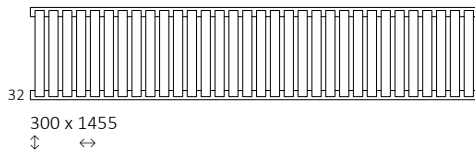
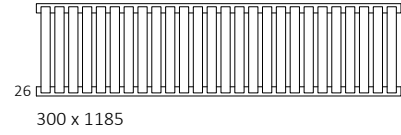
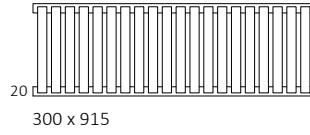
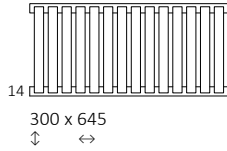

YL

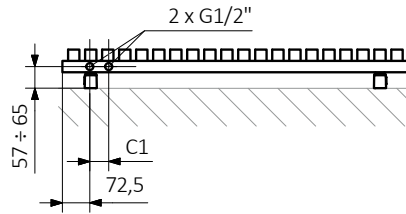

YP

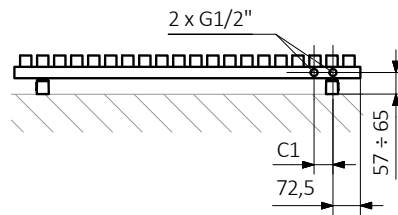

P3

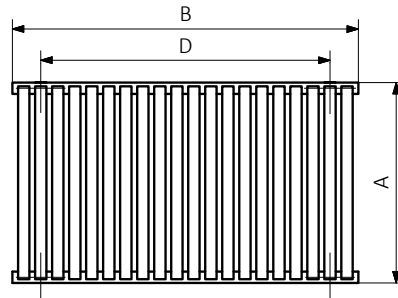
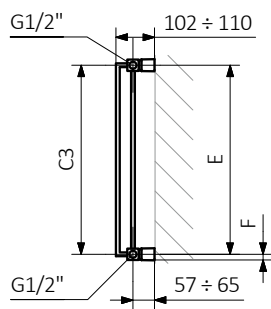

L6

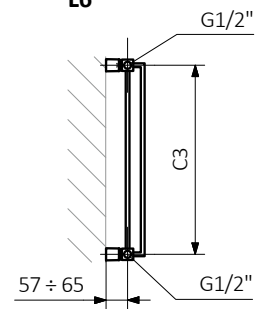

P2

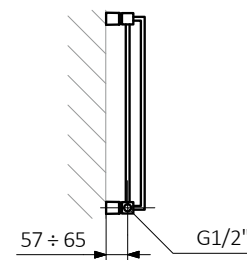
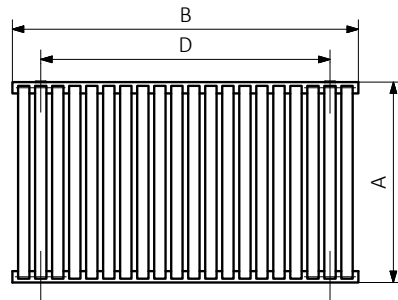
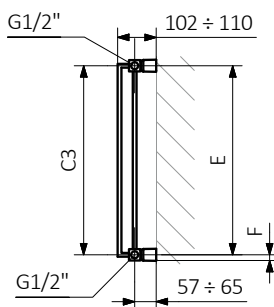

A – Höhe B – Breite C1-C5 – Anschlussabstand D – horizontaler Wandhalterungsabstand E – Vertikaler Wandhalterungsabstand F – Abstand von der Achse der unteren Wandhalterung bis Unterkante des Kollektors

Kollektor:

Rohr:

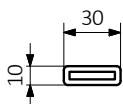
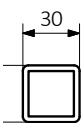

VP

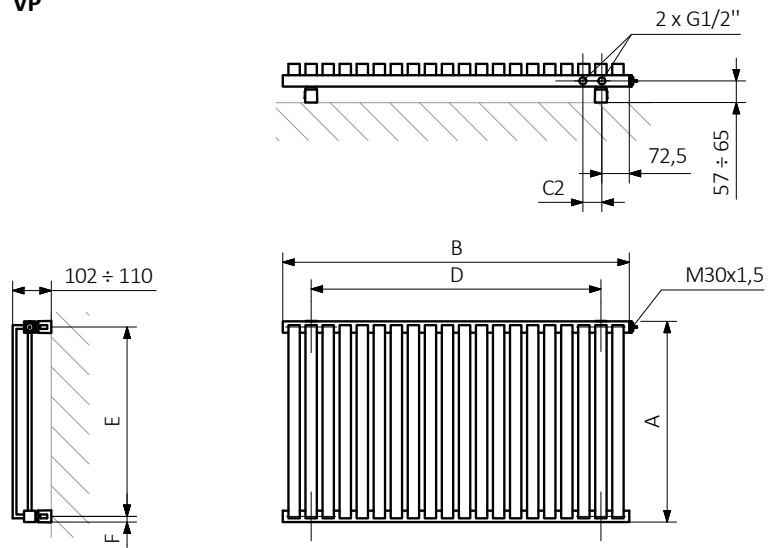

VL

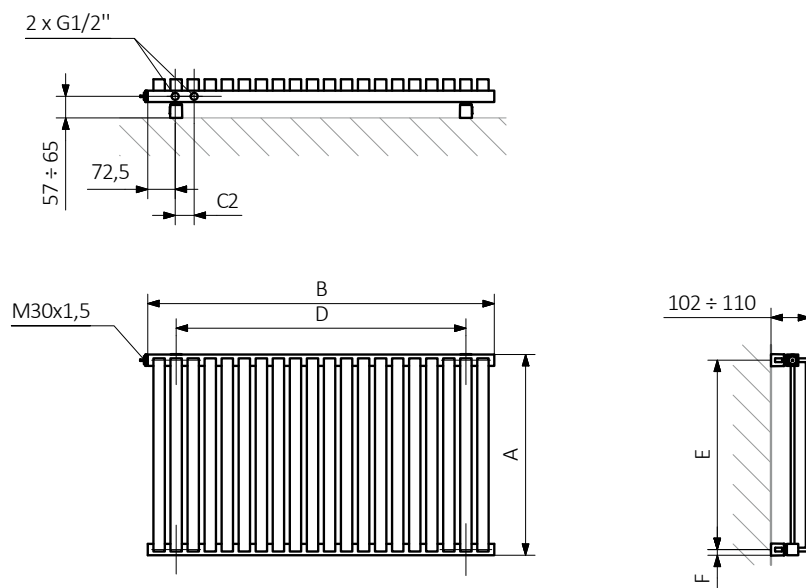



Standard Anschlussstypen:

A \updownarrow 465÷1545:



Elektroheizkörper siehe Seite 321



Weitere mögliche Anschlussstypen:

A \updownarrow 465÷1545:

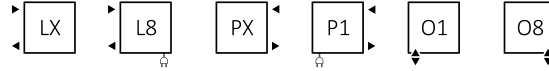

A \updownarrow 735÷1545:

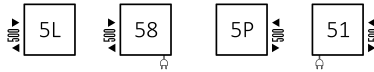

Verfügbare Größen:

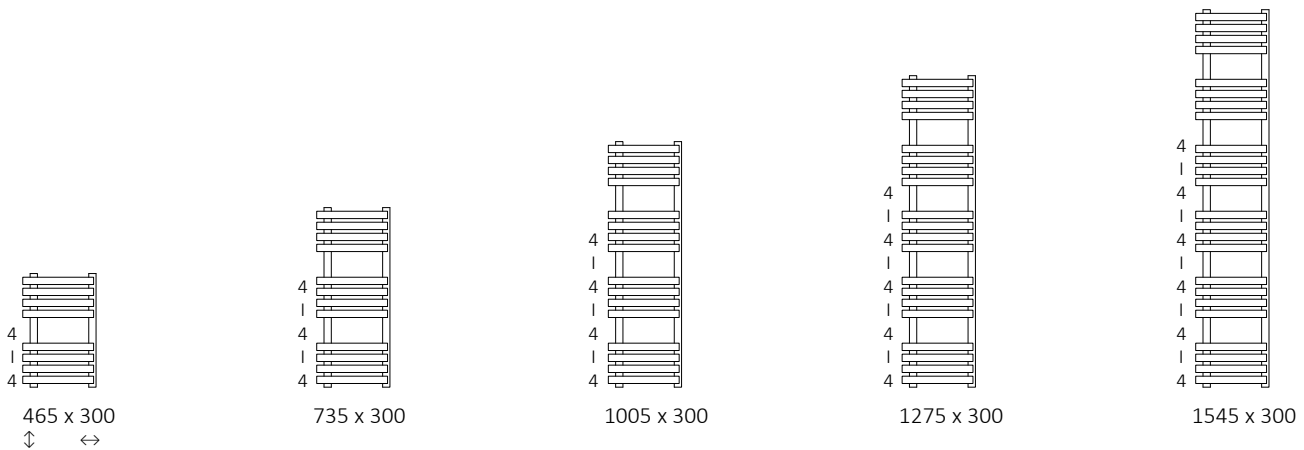

Technische Daten:

Betriebsdruck: 1000 kPa

Maximale Betriebstemperatur: 95°C

A \updownarrow [mm]	B \leftrightarrow [mm]	C2 [mm]	75/65/20°C [W]	55/45/20°C [W]	 [W]	D [mm]	E [mm]	F [mm]	 [dm³]	 [kg]	Artikelnummer <small>(Konfigurations code s. 662)</small>
465	300	195	294	160	300	195	315	76	1,56	5,51	WGQON046030
735	300	195	421	228	400	195	585	76	2,39	8,37	WGQON073030
1005	300	195	547	294	600	195	855	76	3,22	11,23	WGQON100030
1275	300	195	673	361	800	195	1125	76	4,05	14,09	WGQON127030
1545	300	195	799	428	800	195	1395	76	4,89	16,95	WGQON154030

Wir empfehlen: Set Lanzen-Thermostat-Verbund-eckventil für Anschluss O1 und O8



Abdeckblende



Heizpatrone
MOA



Handtuchhalter
ZIP H 10



SX

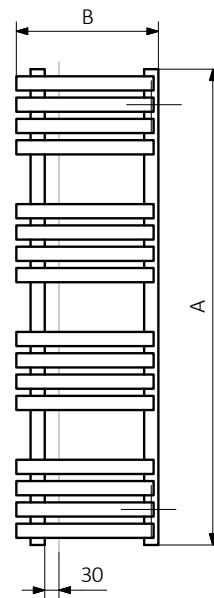
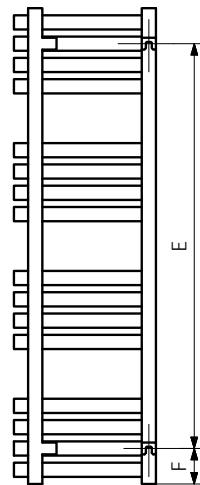
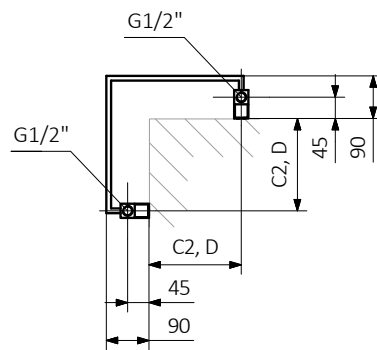

A - Höhe B - Breite C1-C5 - Anschlussabstand D - horizontaler Wandhalterungsabstand E - Vertikaler Wandhalterungsabstand F - Abstand von der Achse der unteren Wandhalterung bis Unterkante des Kollektors

Kollektor:

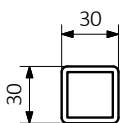

Rohr:

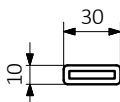



Standard Anschlussstypen:

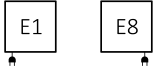

Verfügbare Größen:

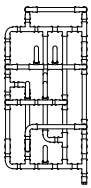

923 x 431
↓ ↔

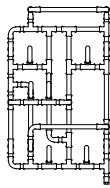

923 x 531

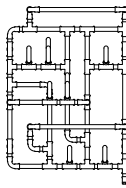

923 x 631

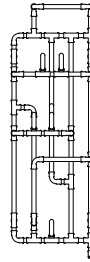

1323 x 431

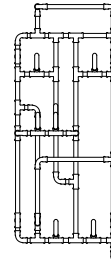

1323 x 531

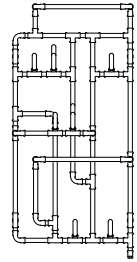

1323 x 631

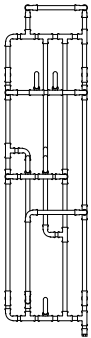

1723 x 431
↓ ↔

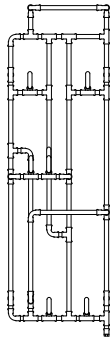

1723 x 531

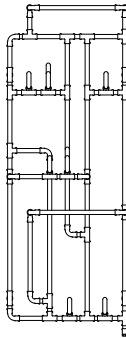

1723 x 631

Technische Daten:

A ↓ [mm]	B ↔ [mm]	[W]	D [mm]	E [mm]	F [mm]	[dm³]	[kg]	Artikelnummer <small>(Konfigurations code s. 664)</small>
923	431	300	400	505	196,5	2,07	10,56	WLPAJ092043
923	531	400	500	505	196,5	2,14	10,98	WLPAJ092053
923	631	400	600	505	196,5	2,40	11,93	WLPAJ092063
1323	431	400	400	852	196,5	2,64	12,10	WLPAJ132043
1323	531	400	500	852	196,5	2,71	12,57	WLPAJ132053
1323	631	600	600	852	196,5	2,96	13,48	WLPAJ132063
1723	431	400	400	1162	196,5	3,20	13,66	WLPAJ172043
1723	531	600	500	1162	196,5	3,26	14,12	WLPAJ172053
1723	631	600	600	1162	196,5	3,52	15,07	WLPAJ172063

Wir empfehlen: Elektroheizpatrone
SIM



E8

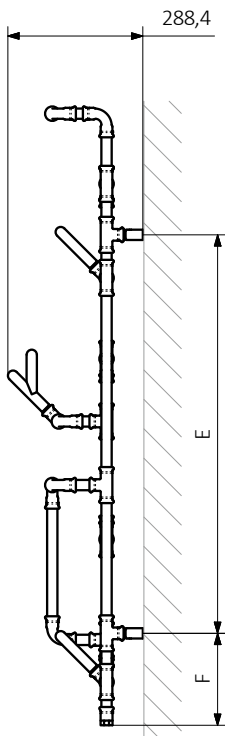

E1

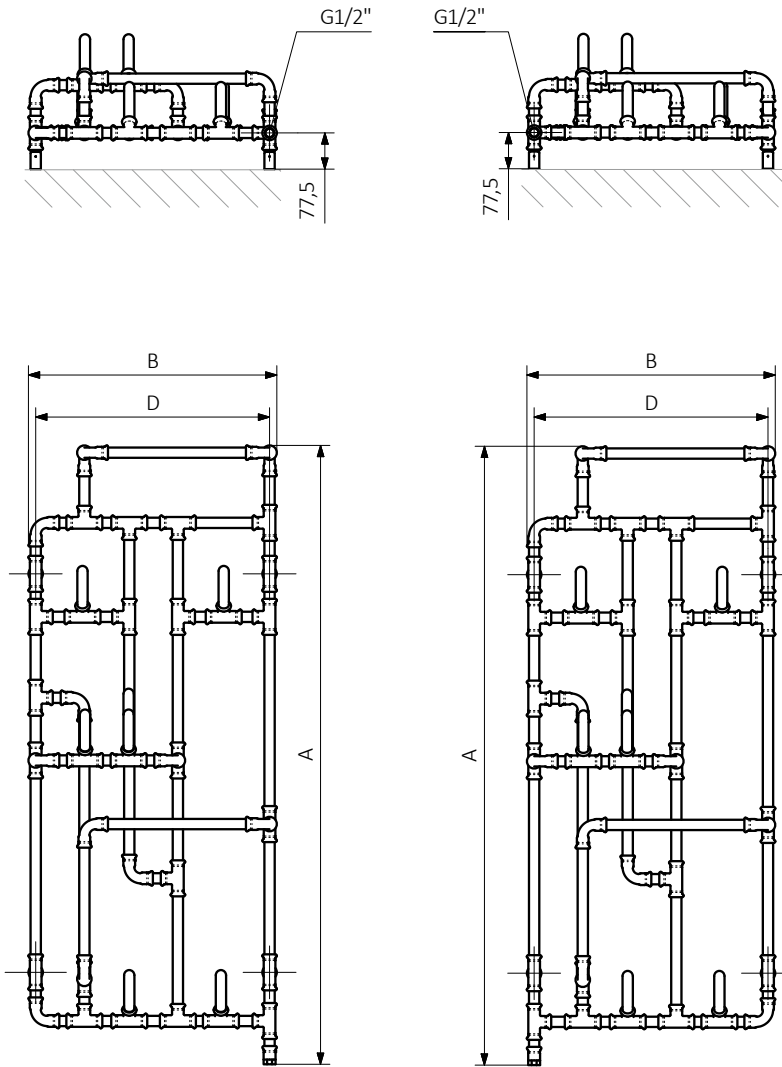

A - Höhe B - Breite C1-C5 - Anschlussabstand D - horizontaler Wandhalterungsabstand E - Vertikaler Wandhalterungsabstand
F - Abstand von der Achse der unteren Wandhalterung bis Unterkante des Kollektors

Rohr:

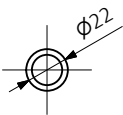



Standard Anschlussarten:



Verfügbare Größen:

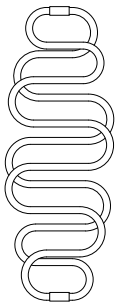

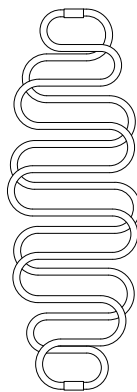

1360 x 500
 ↓ ↔



1760 x 600

Technische Daten:

Elektrische Version mit Heizspirale.

A ↓ [mm]	B ↔ [mm]	 [W]	D [mm]	E [mm]	F [mm]	 [dm ³]	 [kg]	Artikelnummer <small>(Konfigurations code s. 665)</small>
Pulverlack								
1360	500	284	160	600	340	-	13,46	WSPER136050
1760	600	455	290	600	540	-	18,52	WSPER176060
Galvanische Oberfläche								
1360	500	213	160	600	340	-	13,17	WSPER136050
1760	600	284	290	600	540	-	18,09	WSPER176060

EX

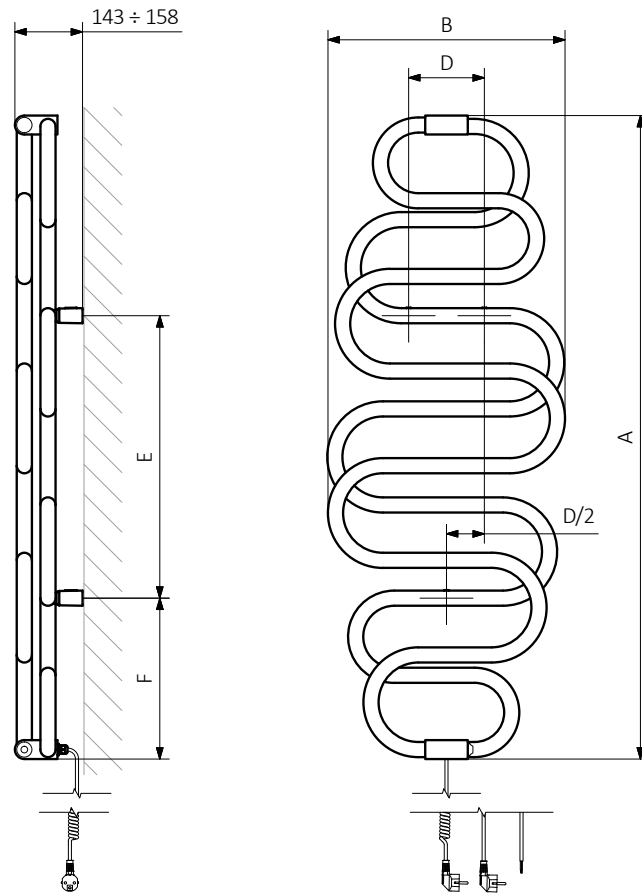

A - Höhe B - Breite C1-C5 - Anschlussabstand D - horizontaler Wandhalterungsabstand E - Vertikaler Wandhalterungsabstand
F - Abstand von der Achse der unteren Wandhalterung bis Unterkante des Kollektors

Rohr:

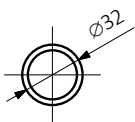



Standard Anschlussstypen:

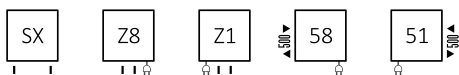

Elektroheizkörper siehe Seite 321

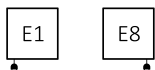

Weitere mögliche Anschlussstypen:

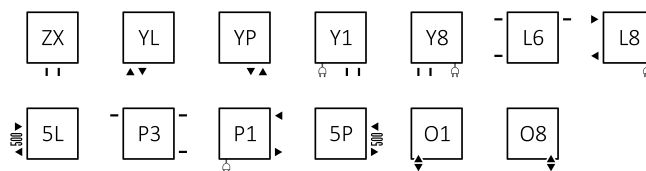

Technische Daten:

Betriebsdruck: 1000 kPa Maximale Betriebstemperatur: 95°C

A ↓ [mm]	B ↔ [mm]	C1 [mm]	C2 [mm]	C5 [mm]	75/65/20°C [W]	55/45/20°C [W]	☺ [W]	D [mm]	E [mm]	F [mm]	U [dm³]	⚖️ [kg]	Artikelnummer <small>(Konfigurations code s. 662)</small>
600	450	50	420	500	308	167	300	420	420	90	3,19	6,48	WGZUL060045
600	500	50	470	500	342	185	400	470	420	90	3,45	7,05	WGZUL060050
600	600	50	570	500	410	222	400	570	420	90	3,99	8,19	WGZUL060060
840	450	50	420	500	443	239	400	420	660	90	4,29	8,76	WGZUL084045
840	500	50	470	500	493	266	600	470	660	90	4,64	9,53	WGZUL084050
840	600	50	570	500	590	318	600	570	660	90	5,36	11,07	WGZUL084060
840	700	50	670	500	690	372	800	670	660	90	6,07	12,60	WGZUL084070
1040	450	50	420	500	556	299	600	420	860	90	5,26	10,80	WGZUL104045
1040	500	50	470	500	618	332	600	470	860	90	5,70	11,73	WGZUL104050
1040	600	50	570	500	743	399	800	570	860	90	6,56	13,61	WGZUL104060
1040	700	50	670	500	866	465	800	670	860	90	7,42	15,48	WGZUL104070
1240	450	50	420	500	669	359	800	420	1060	90	6,19	12,72	WGZUL124045
1240	500	50	470	500	744	399	800	470	1060	90	6,70	13,82	WGZUL124050
1240	600	50	570	500	893	479	1000	570	1060	90	7,71	16,03	WGZUL124060
1240	700	50	670	500	1041	559	1000	670	1060	90	8,72	18,23	WGZUL124070
1400	500	50	470	500	844	452	800	470	1220	90	7,53	15,57	WGZUL140050
1400	600	50	570	500	1013	543	1000	570	1220	90	8,66	18,05	WGZUL140060
1400	700	50	670	500	1182	633	1200	670	1220	90	9,79	20,52	WGZUL140070

Wir empfehlen: Set Winkeleck-Regelventil für Anschluss SX



Heizpatrone MOA



Verfügbare Größen:

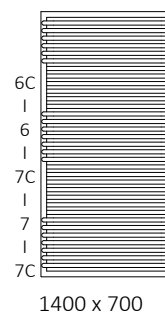
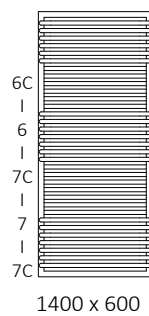
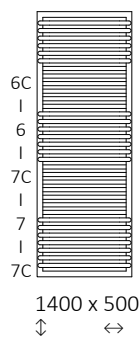
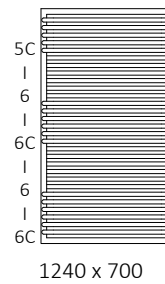
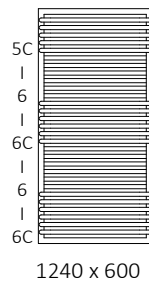
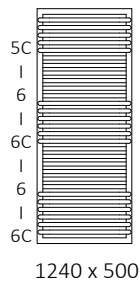
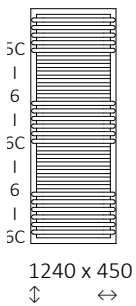
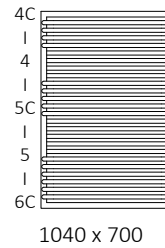
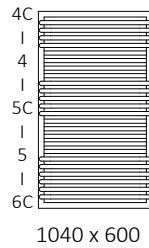
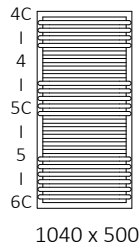
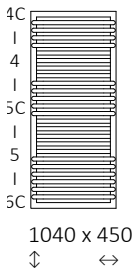
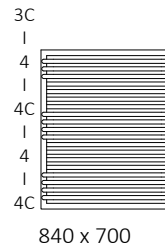
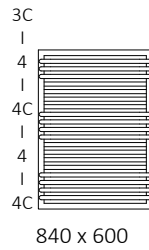
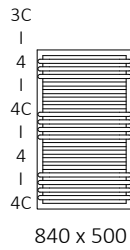
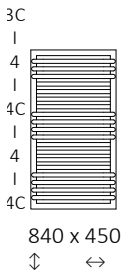
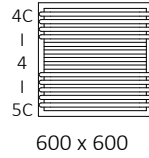
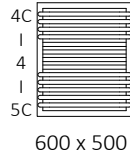
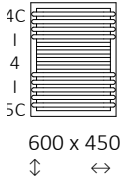

SX

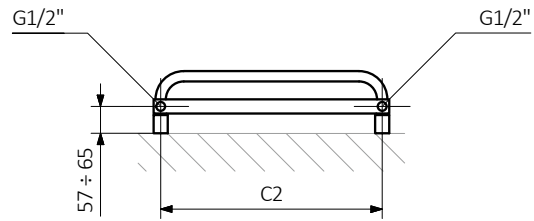

51

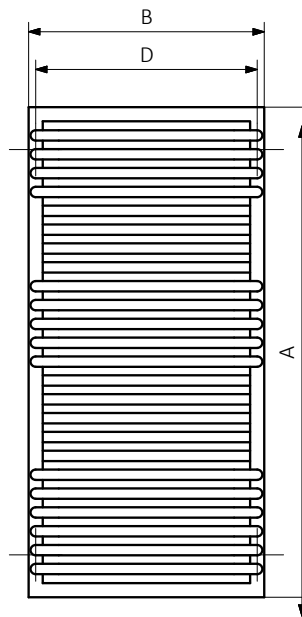
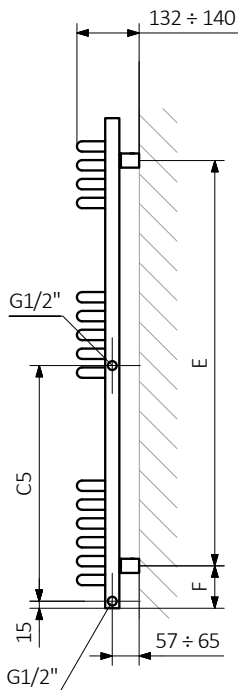
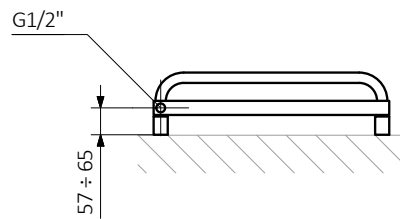

A – Höhe B – Breite C1-C5 – Anschlussabstand D – horizontaler Wandhalterungsabstand E – Vertikaler Wandhalterungsabstand F – Abstand von der Achse der unteren Wandhalterung bis Unterkante des Kollektors

Kollektor:

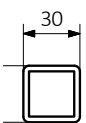

Rohr:

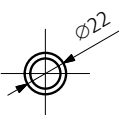

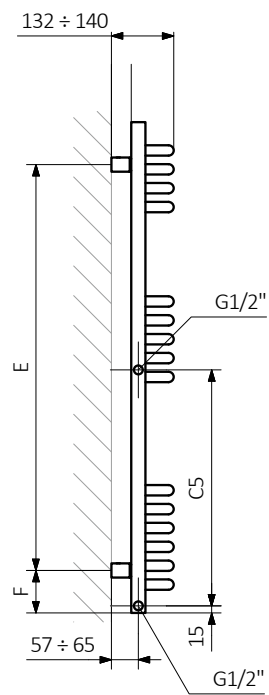
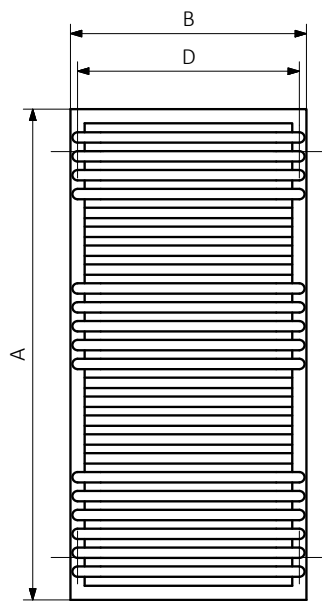
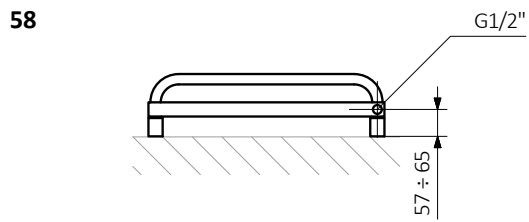
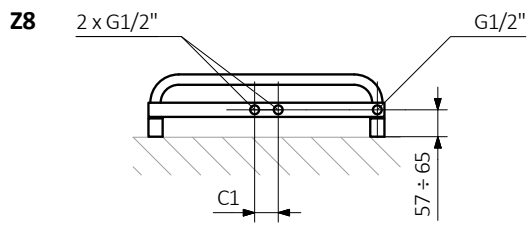



Standard Anschlussstypen:

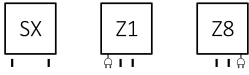

Elektroheizkörper siehe Seite 321

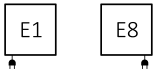

Weitere mögliche Anschlussstypen:

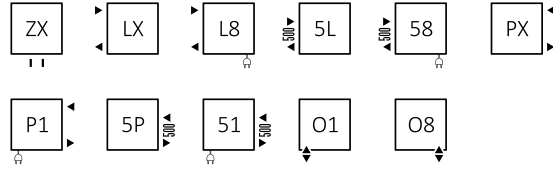

Verfügbare Größen:

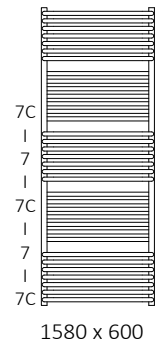
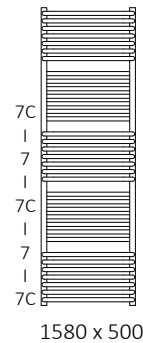
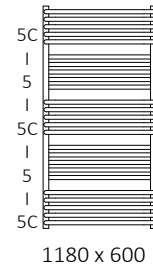
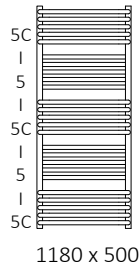
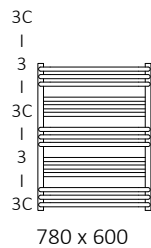
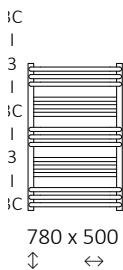

Technische Daten:

Betriebsdruck: 1000 kPa Maximale Betriebstemperatur: 95°C

A ↓ [mm]	B ↔ [mm]	C1 [mm]	C2 [mm]	75/65/20°C [W]	55/45/20°C [W]	[W]	D [mm]	E [mm]	F [mm]	[dm²]	[kg]	Artikelnummer <small>(Konfigurations code s. 662)</small>
-------------	-------------	------------	------------	-------------------	-------------------	-----	-----------	-----------	-----------	-------	------	--

Pulverlack

780	500	50	470	392	211	400	470	600	90	3,34	6,99	WGPAL078050
780	600	50	570	471	254	400	570	600	90	3,79	7,99	WGPAL078060
1180	500	50	470	638	342	600	470	1000	90	5,39	11,28	WGPAL118050
1180	600	50	570	766	411	800	570	1000	90	6,14	12,95	WGPAL118060
1580	500	50	470	883	473	800	470	1400	90	7,44	15,57	WGPAL158050
1580	600	50	570	1061	568	1000	570	1400	90	8,49	17,91	WGPAL158060

Galvanische Oberflächen

780	500	50	470	274	140	300	470	600	90	3,34	6,72	WGPAL078050
780	600	50	570	330	168	300	570	600	90	3,79	7,68	WGPAL078060
1180	500	50	470	447	228	400	470	1000	90	5,39	10,84	WGPAL118050
1180	600	50	570	536	273	600	570	1000	90	6,14	12,44	WGPAL118060
1580	500	50	470	618	315	600	470	1400	90	7,44	14,96	WGPAL158050
1580	600	50	570	743	379	800	570	1400	90	8,49	17,20	WGPAL158060

Wir empfehlen: Set Thermostat Verbundventil für Anschluß Z1 und Z8



Abdeckblende



Heizpatronen Steuerung KTX 3

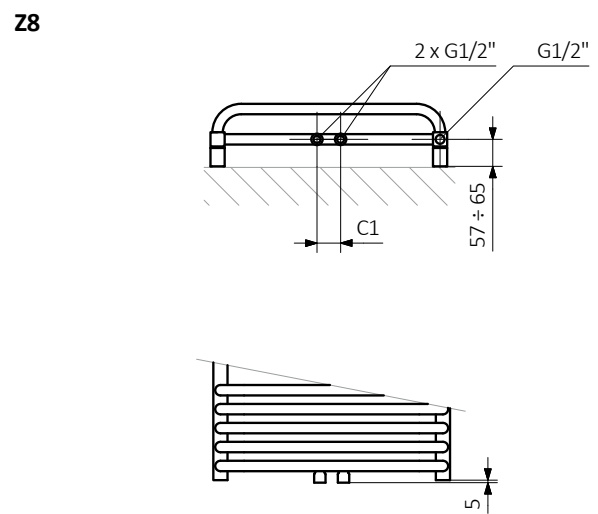
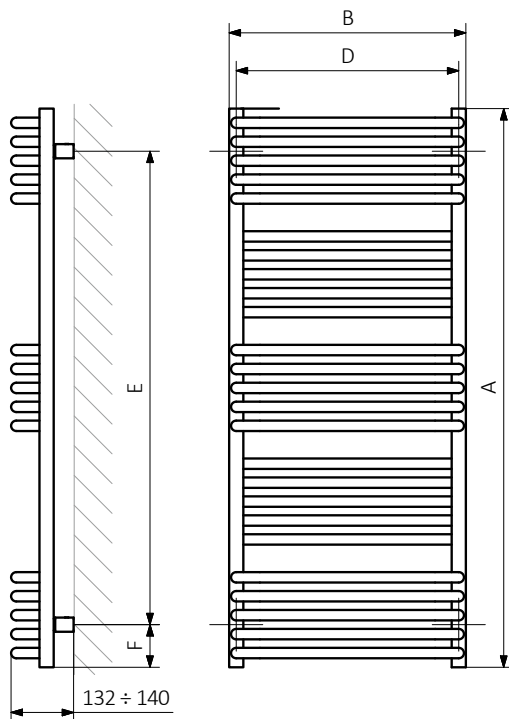
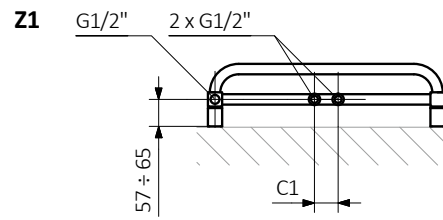
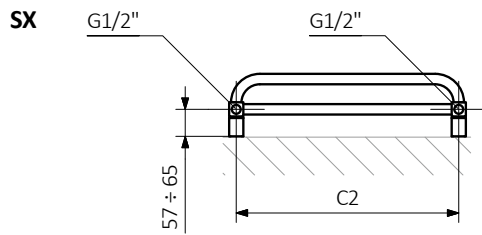

A - Höhe B - Breite C1-C5 - Anschlussabstand D - horizontaler Wandhalterungsabstand E - Vertikaler Wandhalterungsabstand F - Abstand von der Achse der unteren Wandhalterung bis Unterkante des Kollektors

Kollektor:

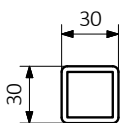

Rohr:

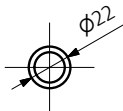



Standard Anschlussstypen:

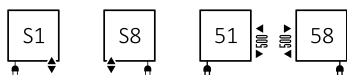

Elektroheizkörper siehe Seite 321

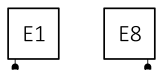

Weitere mögliche Anschlussstypen:

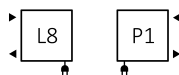

Verfügbare Größen:

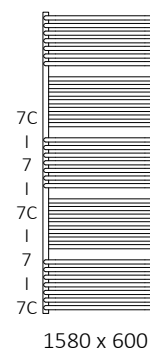
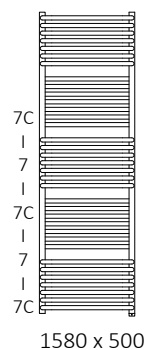
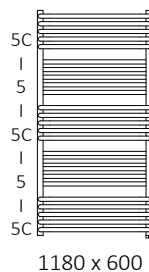
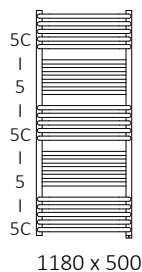
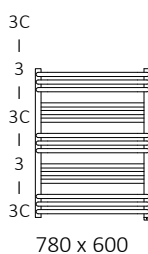
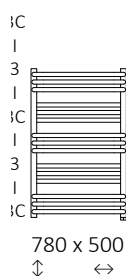

Technische Daten:

Betriebsdruck: 1000 kPa Maximale Betriebstemperatur: 82°C

A ↓ [mm]	B ↔ [mm]	C5 [mm]	75/65/20°C [W]	55/45/20°C [W]	 [W]	D [mm]	E [mm]	F [mm]	 [dm²]	 [kg]	Artikelnummer <small>(Konfigurations code s. 662)</small>
Pulverlack											
780	500	500	392	211	400	470	640	70	3,27	6,99	WZPAN078050
780	600	500	471	254	400	570	640	70	3,72	7,99	WZPAN078060
1180	500	500	638	342	600	470	1040	70	5,33	11,28	WZPAN118050
1180	600	500	766	411	800	570	1040	70	6,07	12,95	WZPAN118060
1580	500	500	883	473	800	470	1440	70	7,38	15,57	WZPAN158050
1580	600	500	1061	568	1000	570	1440	70	8,42	17,91	WZPAN158060
Galvanische Oberfläche											
780	500	500	274	140	300	470	640	70	3,27	6,72	WZPAN078050
780	600	500	330	168	300	570	640	70	3,72	7,68	WZPAN078060
1180	500	500	447	228	400	470	1040	70	5,33	10,84	WZPAN118050
1180	600	500	536	273	600	570	1040	70	6,07	12,44	WZPAN118060
1580	500	500	618	315	600	470	1440	70	7,38	14,96	WZPAN158050
1580	600	500	743	379	800	570	1440	70	8,42	17,20	WZPAN158060

Wir empfehlen: Set Lanzen-Thermostat-Verbund-eckventil für Anschluss S1 und S8

Abdeckblende



S8

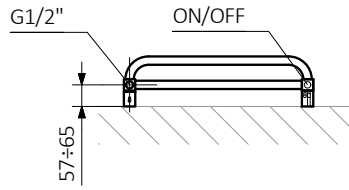

S1

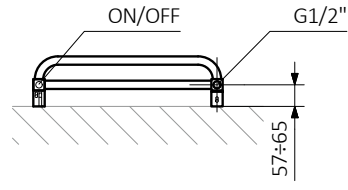

S1

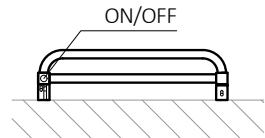

S8

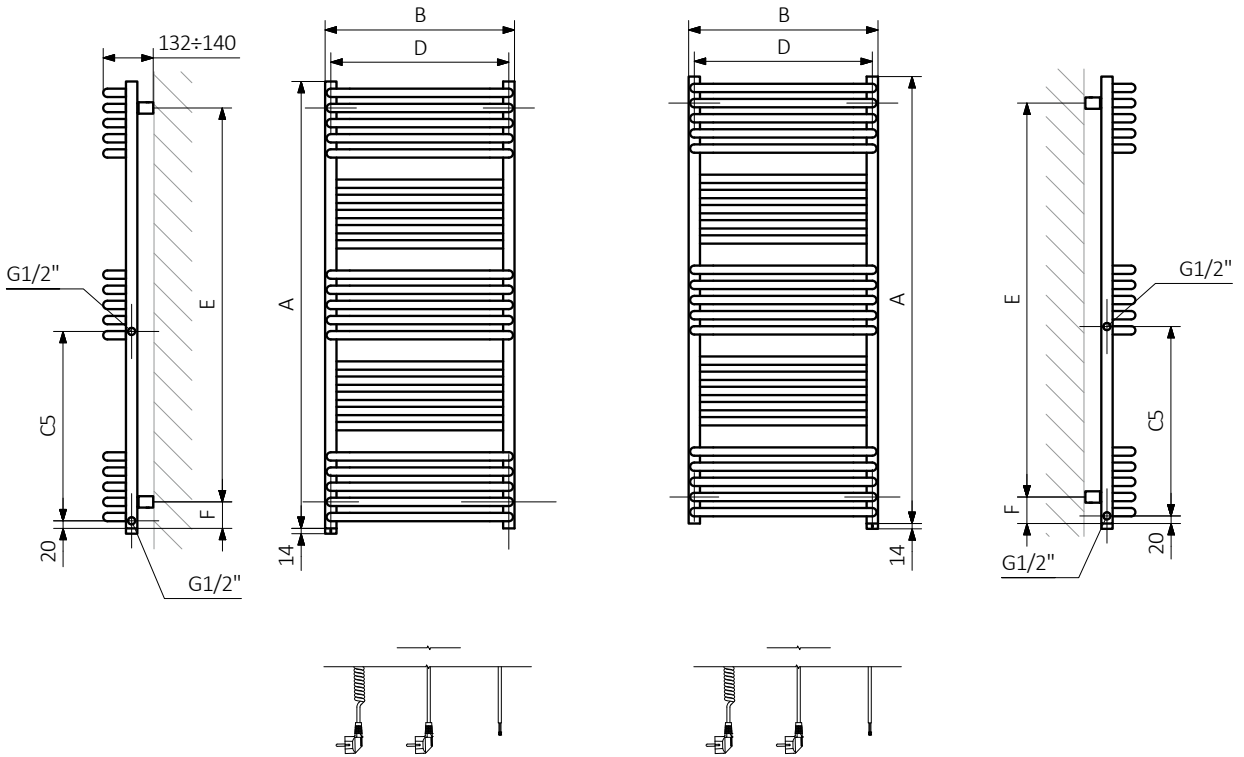
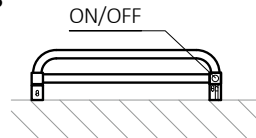

A - Höhe B - Breite C1-C5 - Anschlussabstand D - horizontaler Wandhalterungsabstand E - Vertikaler Wandhalterungsabstand F - Abstand von der Achse der unteren Wandhalterung bis Unterkante des Kollektors

Kollektor:

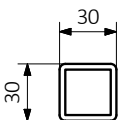

Rohr:

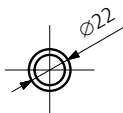



projekt: Terma

Standard Anschlussstypen:

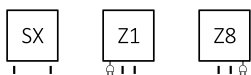

Elektroheizkörper siehe Seite 321

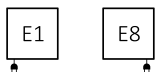

Weitere mögliche Anschlussstypen:

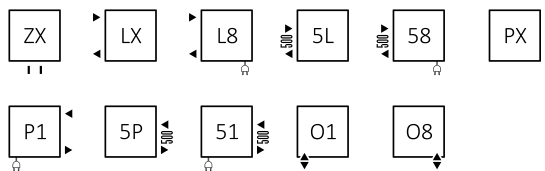

Verfügbare Größen:

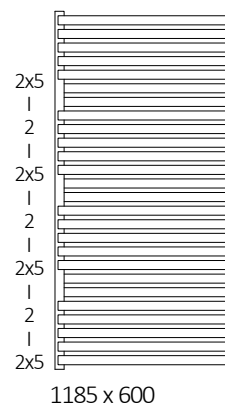
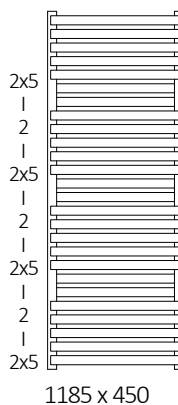
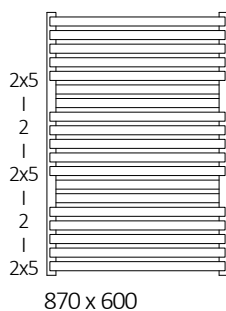
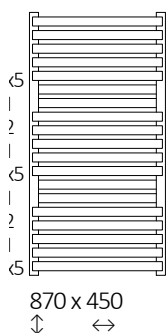

Technische Daten:

Betriebsdruck: 1000 kPa

Maximale Betriebstemperatur: 95°C

A ↓ [mm]	B ↔ [mm]	C1 [mm]	C2 [mm]	75/65/20°C [W]	55/45/20°C [W]	☺ [W]	D [mm]	E [mm]	F [mm]	⊞ [dm ²]	⚖ [kg]	Artikelnummer <small>(Konfigurations code s. 662)</small>
870	450	50	420	531	285	600	420	690	90	4,11	15,70	WGQBA087045
870	600	50	570	708	380	800	570	690	90	5,08	20,24	WGQBA087060
1185	450	50	420	835	446	800	420	1005	90	5,57	21,23	WGQBA118045
1185	600	50	570	1113	594	1200	570	1005	90	6,88	27,38	WGQBA118060

Wir empfehlen: Set Thermostat Verbunddeckventil für Anschluss Z1 und Z8

Abdeckblende

Heizpatronen Steuerung KTX 2



SX

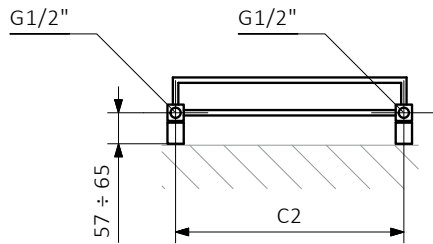

Z1

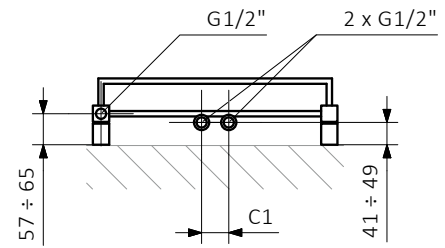

Z8

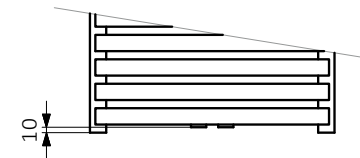
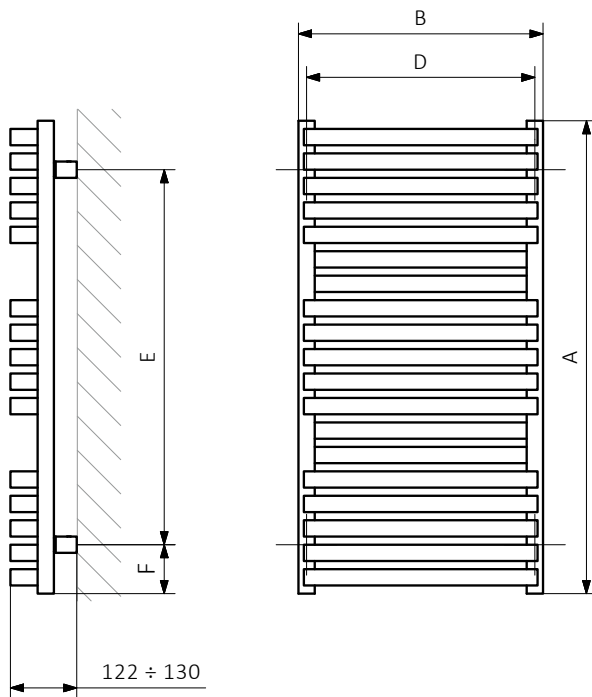
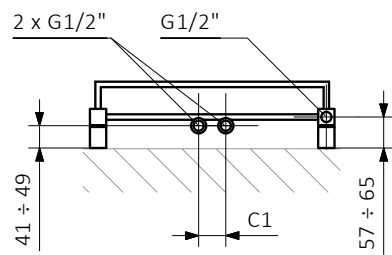

A – Höhe B – Breite C1-C5 – Anschlussabstand D – horizontaler Wandhalterungsabstand E – Vertikaler Wandhalterungsabstand F – Abstand von der Achse der unteren Wandhalterung bis Unterkante des Kollektors

Kollektor:

Rohr:

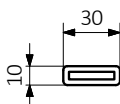
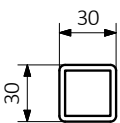

Quadrus Bold One

Seite 106



projekt: *Terma*

Standard Anschlussstypen:

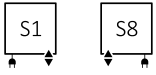

Elektroheizkörper siehe Seite 321

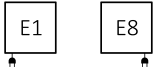

Weitere mögliche Anschlussstypen:

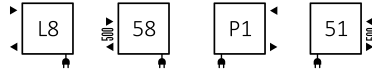

Verfügbare Größen:

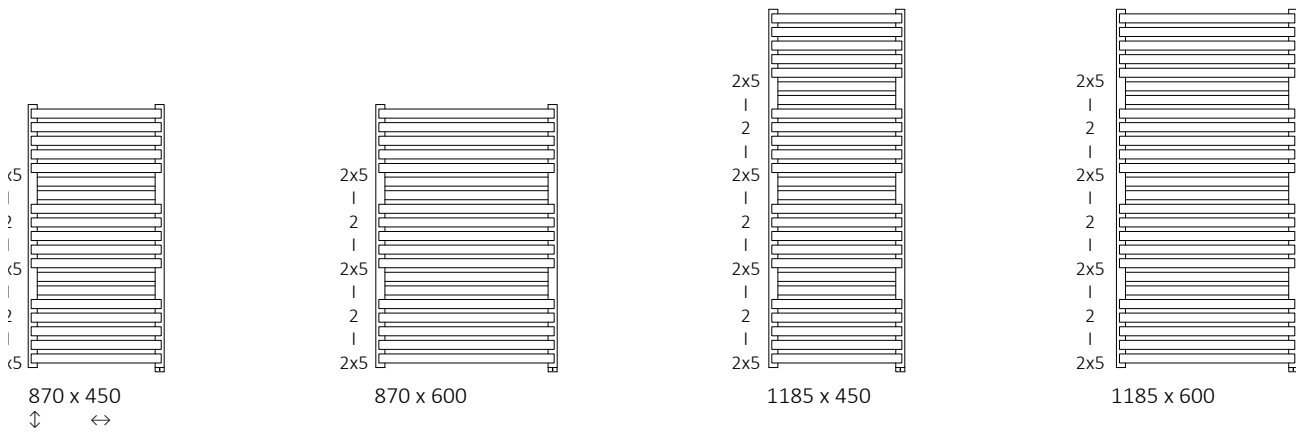

Technische Daten:

Betriebsdruck: 1000 kPa Maximale Betriebstemperatur: 82°C

A ↓ [mm]	B ↔ [mm]	75/65/20°C [W]	55/45/20°C [W]	[W]	D [mm]	E [mm]	F [mm]	[dm³]	[kg]	Artikelnummer <small>(Konfigurations code s. 663)</small>
870	450	531	285	600	420	720	75	4,05	15,70	WZQBN087045
870	600	708	380	800	570	720	75	5,01	20,24	WZQBN087060
1185	450	835	446	800	420	1035	75	5,50	21,23	WZQBN118045
1185	600	1113	594	1200	570	1035	75	6,81	27,38	WZQBN118060

Wir empfehlen: Set Lanzen-Thermostat-Verbunddeckventil für Anschluss S1 und S8

Abdeckblende



S1

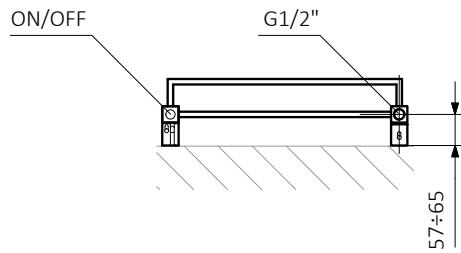

S8

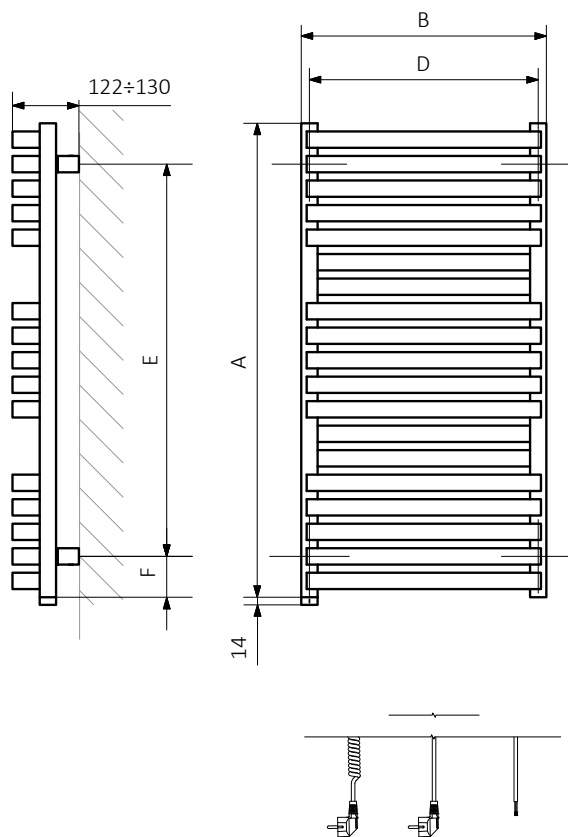
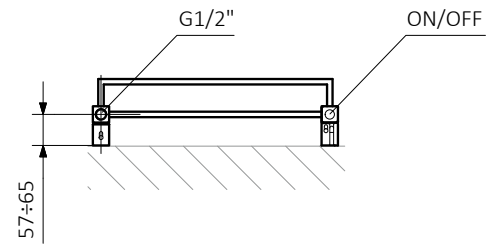

A – Höhe B – Breite C1-C5 – Anschlussabstand D – horizontaler Wandhalterungsabstand E – Vertikaler Wandhalterungsabstand F – Abstand von der Achse der unteren Wandhalterung bis Unterkante des Kollektors

Kollektor:

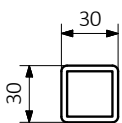

Rohr:

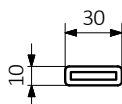

Quadrus Slim

Seite 110



projekt: *Terma*

Standard Anschlussstypen:

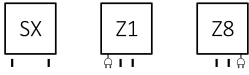

Elektroheizkörper siehe Seite 321

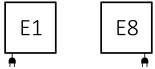

Weitere mögliche Anschlussstypen:

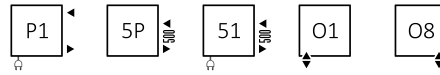
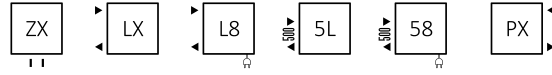

Verfügbare Größen:

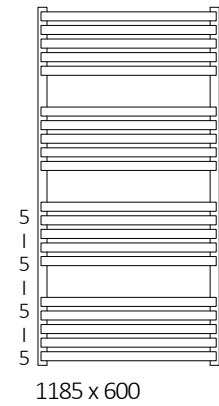
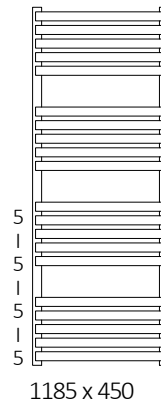
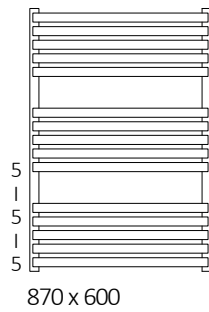
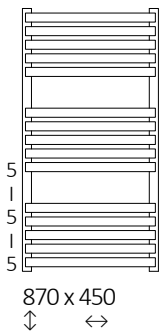

Technische Daten:

Betriebsdruck: 1000 kPa

Maximale Betriebstemperatur: 95°C

A ↓ [mm]	B ↔ [mm]	C1 [mm]	C2 [mm]	75/65/20°C [W]	55/45/20°C [W]	☺ [W]	D [mm]	E [mm]	F [mm]	⊞ [dm³]	⚖ [kg]	Artikelnummer <small>(Konfigurations code s. 662)</small>
870	450	50	420	409	217	400	420	690	90	2,60	8,81	WGQUS087045
870	600	50	570	559	296	600	570	690	90	3,03	10,81	WGQUS087060
1185	450	50	420	537	278	600	420	1005	90	3,50	11,76	WGQUS118045
1185	600	50	570	733	379	800	570	1005	90	4,07	14,43	WGQUS118060

Wir empfehlen: Set Thermostat Verbunddeckventil für Anschluss Z1 und Z8



Abdeckblende



Heizpatronen Steuerung KTX 4



Handtuchhalter ZIP H 10



SX

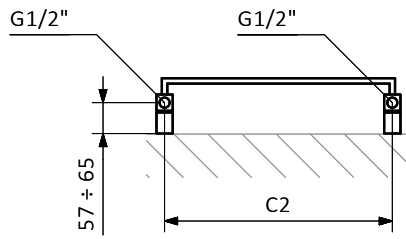

Z1

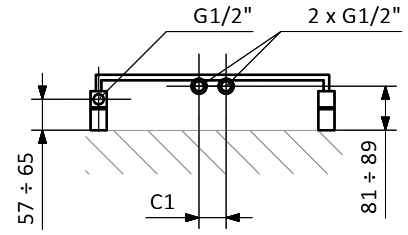

Z8

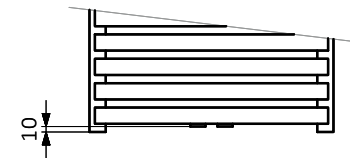
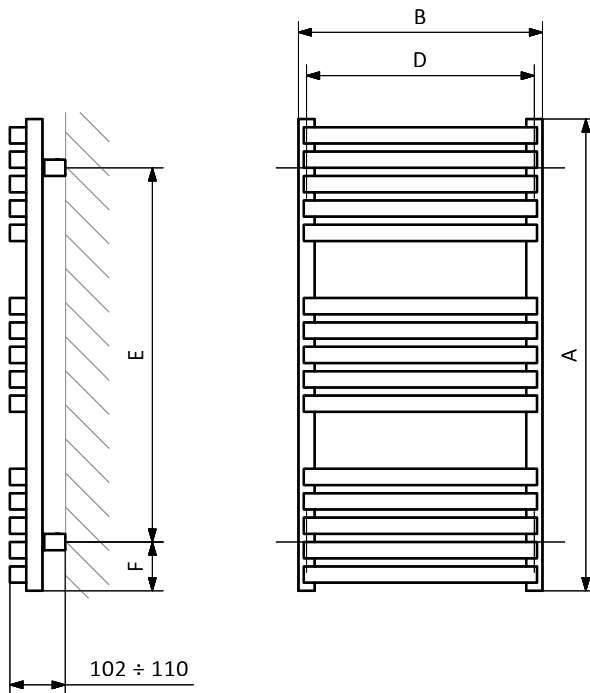
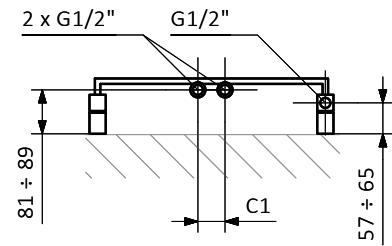

A – Höhe B – Breite C1-C5 – Anschlussabstand D – horizontaler Wandhalterungsabstand E – Vertikaler Wandhalterungsabstand F – Abstand von der Achse der unteren Wandhalterung bis Unterkante des Kollektors

Kollektor:

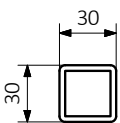

Rohr:

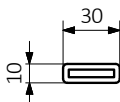

Quadrus Slim One

Seite 110



projekt: *Terma*

Standard Anschlussstypen:

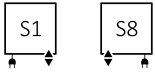

Elektroheizkörper siehe Seite 321

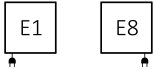

Weitere mögliche Anschlussstypen:

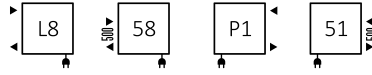

Verfügbare Größen:

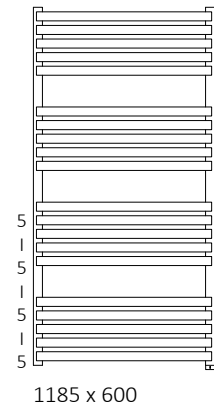
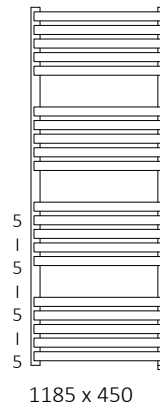
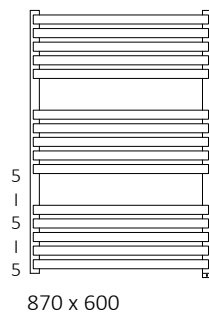
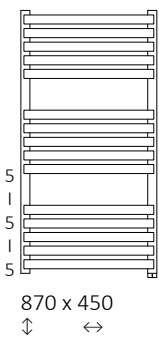

Technische Daten:

Betriebsdruck: 1000 kPa Maximale Betriebstemperatur: 82°C

A ↓ [mm]	B ↔ [mm]	75/65/20°C [W]	55/45/20°C [W]	[W]	D [mm]	E [mm]	F [mm]	[dm³]	[kg]	Artikelnummer <small>(Konfigurations code s. 663)</small>
870	450	409	217	400	420	720	75	2,53	8,81	WZQSN087045
870	600	559	296	600	570	720	75	2,96	10,81	WZQSN087060
1185	450	537	278	600	420	1035	75	3,43	11,76	WZQSN118045
1185	600	733	379	800	570	1035	75	4,00	14,43	WZQSN118060

Wir empfehlen: Set Lanzen-Thermostat-Verbundventil für Anschluss S1 und S8

Abdeckblende

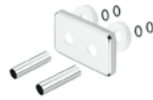

S8

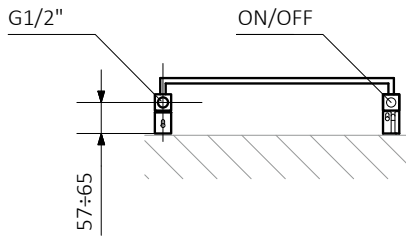

S1

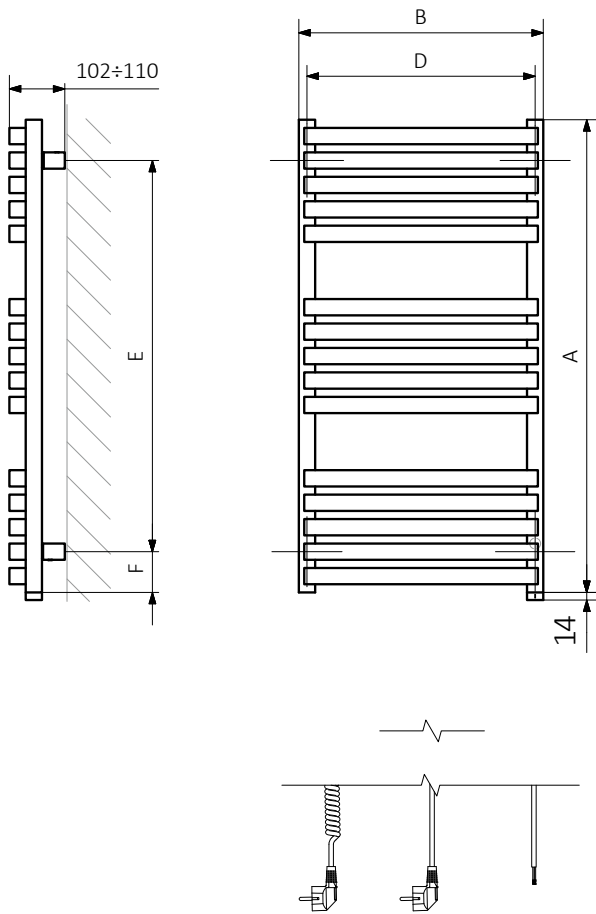
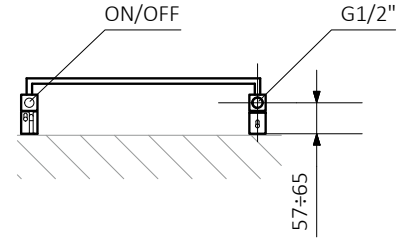

A – Höhe B – Breite C1-C5 – Anschlussabstand D – horizontaler Wandhalterungsabstand E – Vertikaler Wandhalterungsabstand F – Abstand von der Achse der unteren Wandhalterung bis Unterkante des Kollektors

Kollektor:

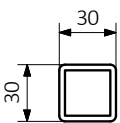

Rohr:

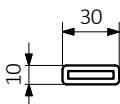



Standard Anschlussstypen:



Elektroheizkörper siehe Seite 321



Verfügbare Größen:

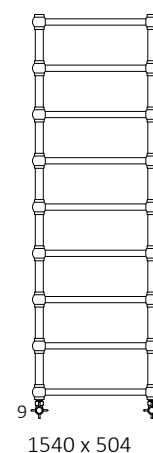
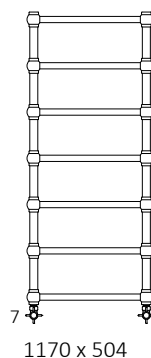
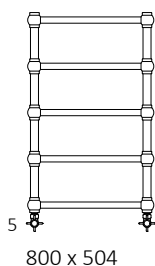
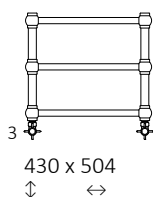

Technische Daten:

Betriebsdruck: 1000 kPa Maximale Betriebstemperatur: 95°C

A ↓ [mm]	B ↔ [mm]	C2 [mm]	75/65/20°C [W]	55/45/20°C [W]	☉ [W]	D [mm]	E [mm]	F [mm]	📄 [dm³]	📖 [kg]	Artikelnummer <small>(Konfigurations code s. 662)</small>
Pulverlack											
430	504	450	115	63	120	450	370	30	1,05	5,57	WGRE1043050
800	504	450	210	114	200	450	740	30	1,88	8,49	WGRE1080050
1170	504	450	308	165	300	450	1110	30	2,71	11,40	WGRE1117050
1540	504	450	405	216	400	450	1480	30	3,54	14,32	WGRE1154050
Galvanische Oberfläche											
430	504	450	81	44	120	450	370	30	1,05	5,48	WGRE1043050
800	504	450	147	80	120	450	740	30	1,88	8,33	WGRE1080050
1170	504	450	216	116	200	450	1110	30	2,71	11,19	WGRE1117050
1540	504	450	284	151	300	450	1480	30	3,54	14,05	WGRE1154050

Enthält: Wasser-Heizkörper wird geliefert mit kompletter Anschlussgarnitur Star (Regel-Eckventile) und Adaptern für die Installation (Alupex Ø 16x2 und Kupfer Ø 15). Alle Elemente dieser Armatur sind komplett verchromt.

Wir empfehlen: Set einteilige
Blende



SX

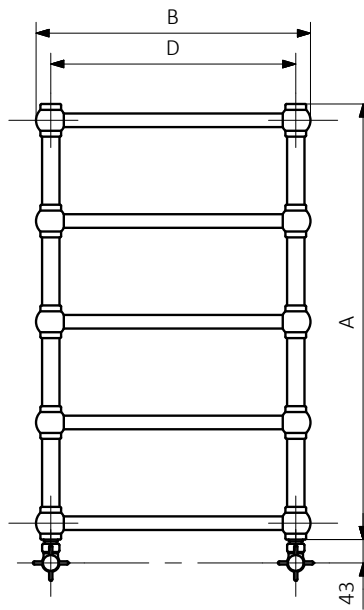
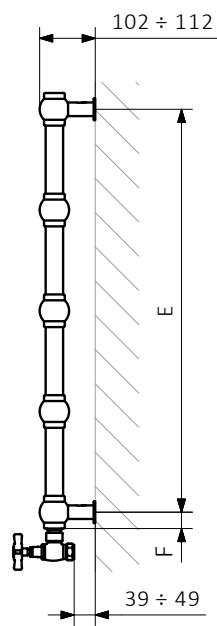
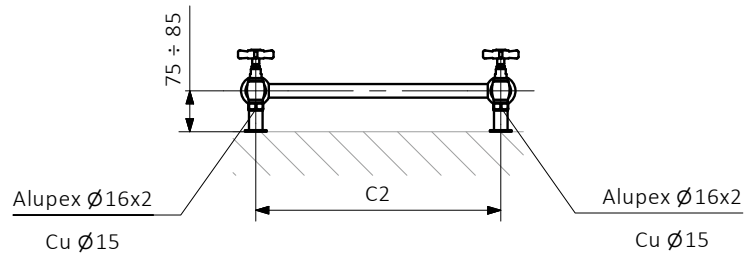

A – Höhe B – Breite C1-C5 – Anschlussabstand D – horizontaler Wandhalterungsabstand E – Vertikaler Wandhalterungsabstand F – Abstand von der Achse der unteren Wandhalterung bis Unterkante des Kollektors

Kollektor:

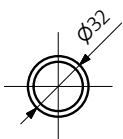

Rohr:

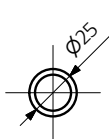



projekt: *Terma*

Standard Anschlussstypen:

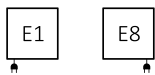

Verfügbare Größen:

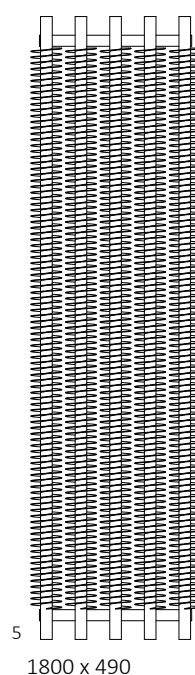
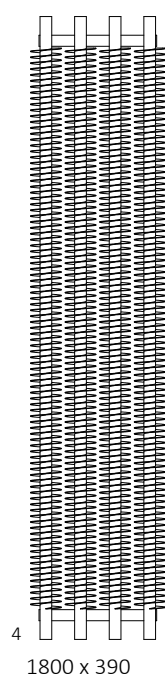
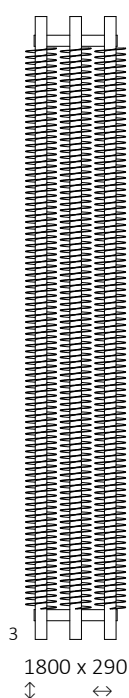

Technische Daten:

A ↕ [mm]	B ↔ [mm]	[W]	D [mm]	E [mm]	F [mm]	[dm³]	[kg]	Artikelnummer <small>(Konfigurations code s. 664)</small>
1800	290	600	100	1660	70	3,33	28,52	WLRVE180029
1800	390	800	200	1660	70	4,45	38,03	WLRVE180039
1800	490	1000	300	1660	70	5,57	47,55	WLRVE180049

Wir empfehlen: Heizpatrone
MOA



E8

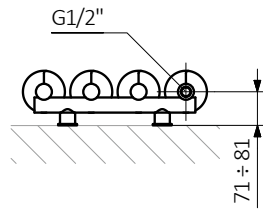

E1

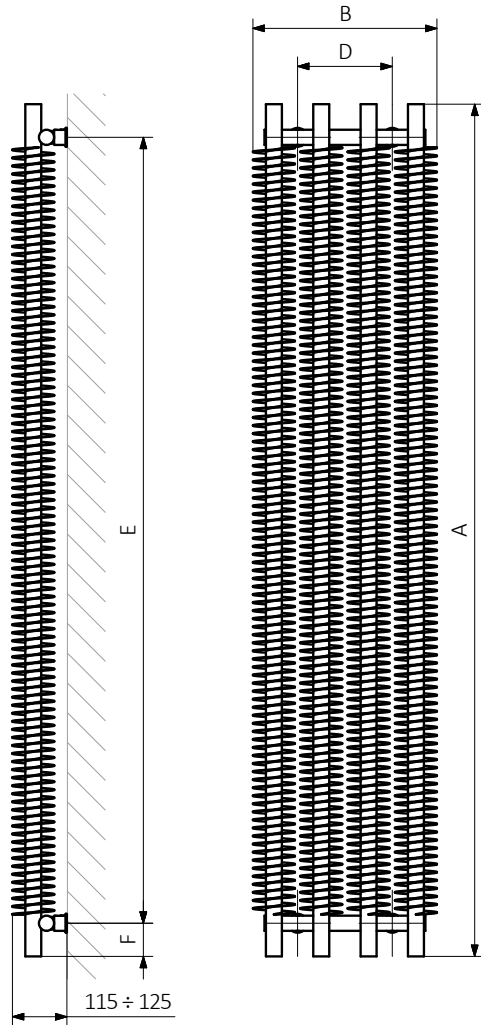
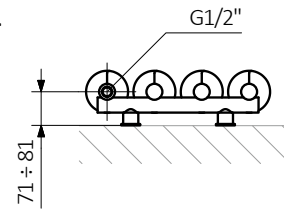

A - Höhe B - Breite C1-C5 - Anschlussabstand D - horizontaler Wandhalterungsabstand E - Vertikaler Wandhalterungsabstand
F - Abstand von der Achse der unteren Wandhalterung bis Unterkante des Kollektors

Kollektor:

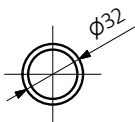

Rohr:

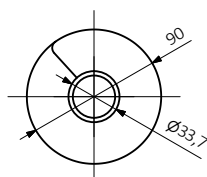



projekt: Jacek Ryń

Standard Anschlussstypen:

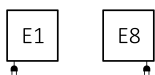

Verfügbare Größen:

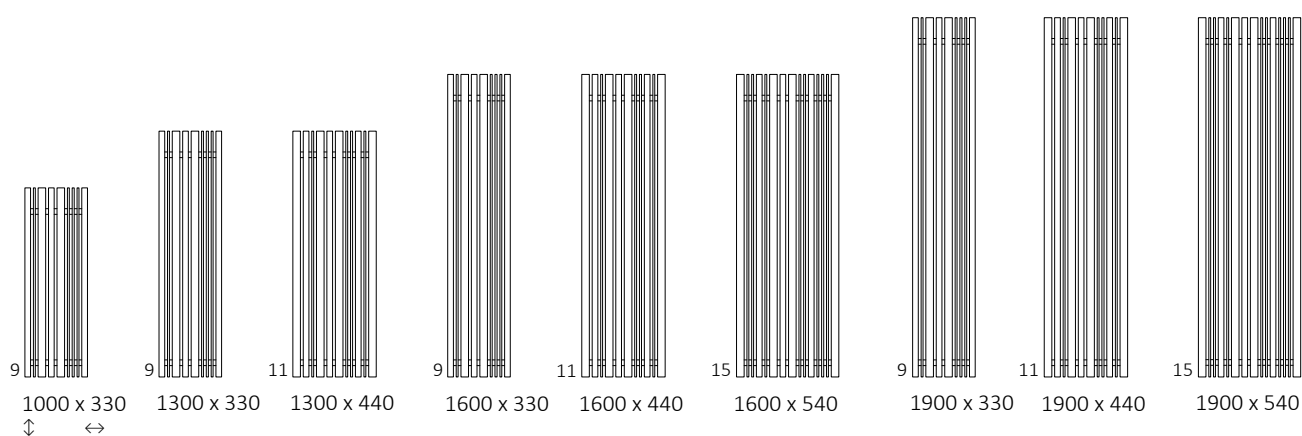

Technische Daten:

A ↓ [mm]	B ↔ [mm]	[W]	D [mm]	E [mm]	F [mm]	[dm³]	[kg]	Artikelnummer <small>(Konfigurations code s. 664)</small>
1000	330	600	220	800	75	5,53	18,10	WLSTV100033
1300	330	600	220	1100	75	7,05	23,06	WLSTV130033
1300	440	800	330	1100	75	9,80	29,81	WLSTV130044
1600	330	800	220	1400	75	8,58	28,04	WLSTV160033
1600	440	1000	330	1400	75	11,92	36,22	WLSTV160044
1600	540	1200	430	1400	75	13,45	43,99	WLSTV160054
1900	330	800	220	1700	75	10,10	33,01	WLSTV190033
1900	440	1200	330	1700	75	14,05	42,62	WLSTV190044
1900	540	1500	430	1700	75	15,84	51,79	WLSTV190054

Wir empfehlen: Elektroheizpatrone
SIM



E1

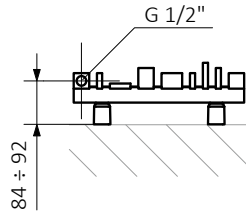

E8

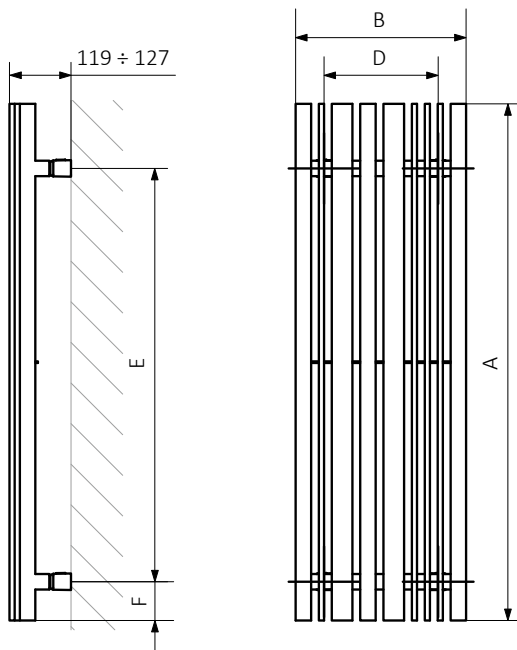
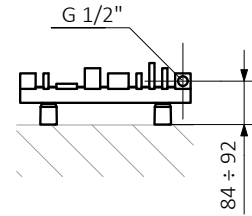

A - Höhe B - Breite C1-C5 - Anschlussabstand D - horizontaler Wandhalterungsabstand E - Vertikaler Wandhalterungsabstand
F - Abstand von der Achse der unteren Wandhalterung bis Unterkante des Kollektors

Kollektor:

Rohr:

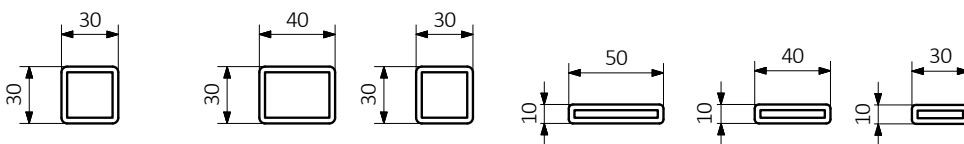



Standard Anschlussstypen:

A=560-610:



A=900-1900:

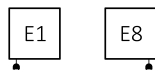

Technische Daten:

A ↓ [mm]	B ↔ [mm]	[W]	D [mm]	E [mm]	F [mm]	[dm³]	[kg]	Artikelnummer <small>(Konfigurationscode s. 664)</small>
560	480	400	450	380	90	5,72	14,77	WLTRG056048
560	680	600	650	380	90	8,01	20,74	WLTRG056068
560	880	600	850	380	90	10,31	26,71	WLTRG056088
560	1080	800	1050	380	90	12,60	32,68	WLTRG056108
560	1280	1000	1250	380	90	14,90	38,65	WLTRG056128
610	480	400	450	430	90	6,22	15,97	WLTRG061048
610	680	600	650	430	90	8,71	22,42	WLTRG061068
610	880	800	850	430	90	11,21	28,87	WLTRG061088
610	1080	800	1050	430	90	13,70	35,32	WLTRG061108
610	1280	1000	1250	430	90	16,19	41,76	WLTRG061128
900	380	400	350	720	90	7,29	18,30	WLTRG090038
900	480	600	450	720	90	9,11	22,92	WLTRG090048
900	580	800	550	720	90	10,94	27,53	WLTRG090058
900	680	800	650	720	90	12,76	32,15	WLTRG090068
1300	380	600	350	1120	90	10,48	25,97	WLTRG130038
1300	480	800	450	1120	90	13,10	32,50	WLTRG130048
1300	580	1000	550	1120	90	15,72	39,03	WLTRG130058
1300	680	1200	650	1120	90	18,34	45,56	WLTRG130068
1700	380	800	350	1520	90	13,67	33,64	WLTRG170038
1700	480	1000	450	1520	90	17,09	42,08	WLTRG170048
1700	580	1200	550	1520	90	20,51	50,53	WLTRG170058
1700	680	1500	650	1520	90	23,93	58,98	WLTRG170068
1900	380	1000	350	1720	90	15,26	37,47	WLTRG190038
1900	480	1200	450	1720	90	19,08	46,87	WLTRG190048
1900	580	1500	550	1720	90	22,90	56,28	WLTRG190058
1900	680	1500	650	1720	90	26,72	65,68	WLTRG190068

Wir empfehlen: Heizpatrone
ONE

Handtuchhalter
ZIP V 40



Verfügbare Größen:

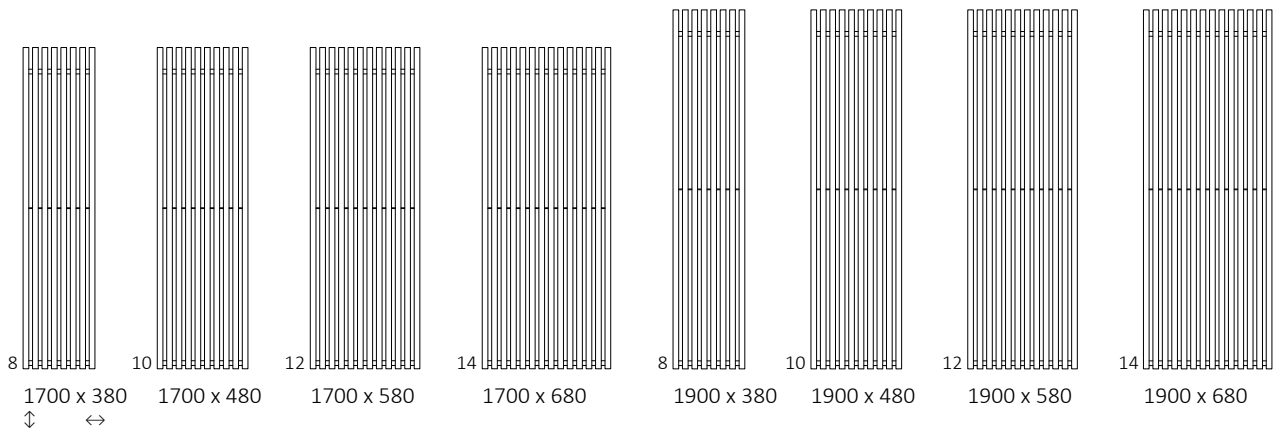
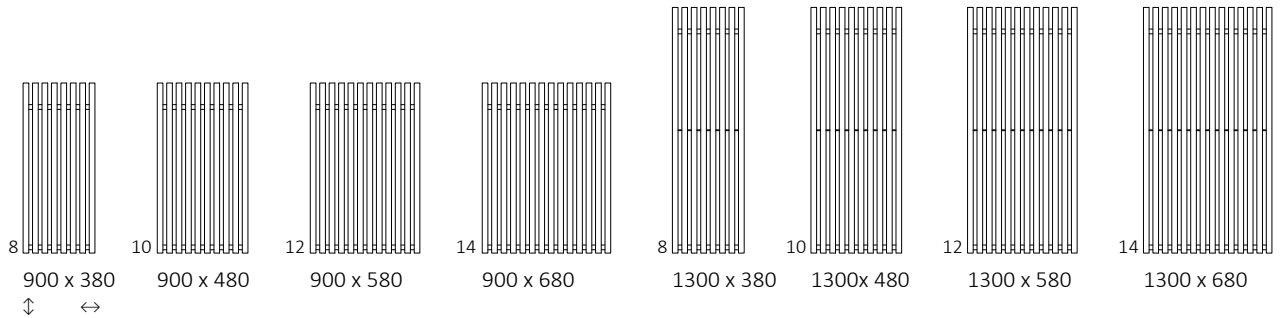
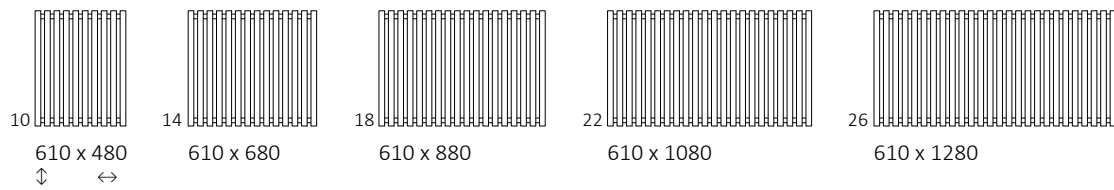
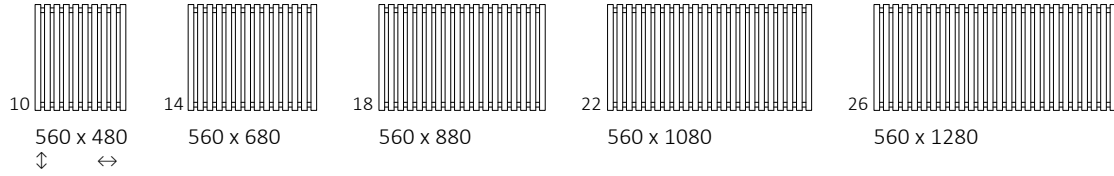

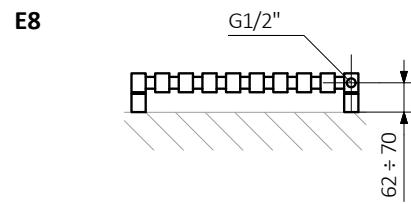
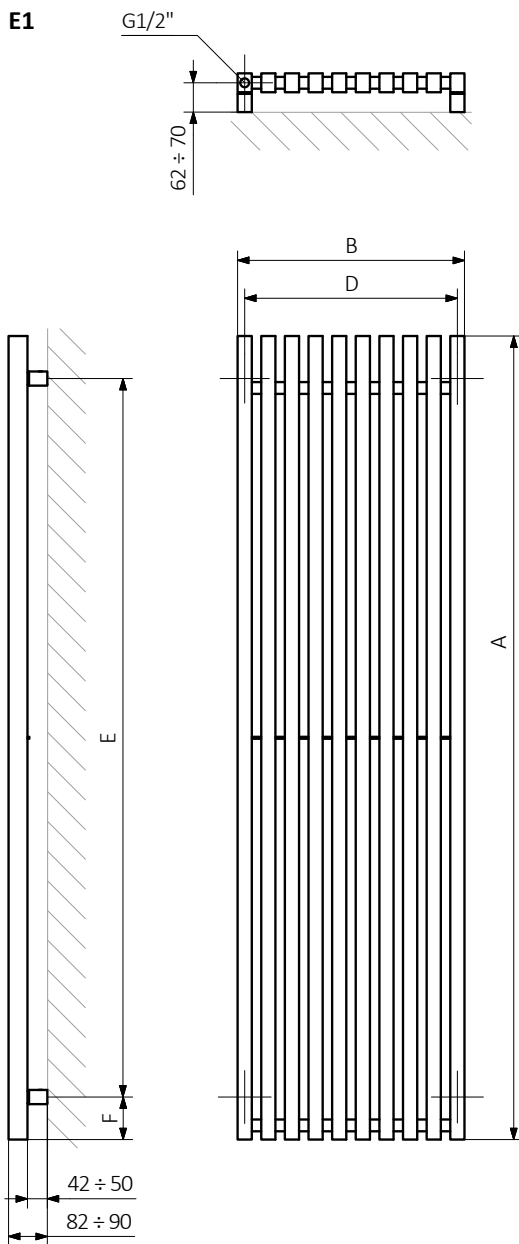

A – Höhe B – Breite C1-C5 – Anschlussabstand D – horizontaler Wandhalterungsabstand E – Vertikaler Wandhalterungsabstand
 F – Abstand von der Achse der unteren Wandhalterung bis Unterkante des Kollektors

Kollektor:

Rohr:

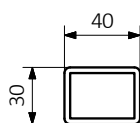
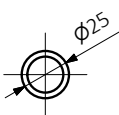

E2

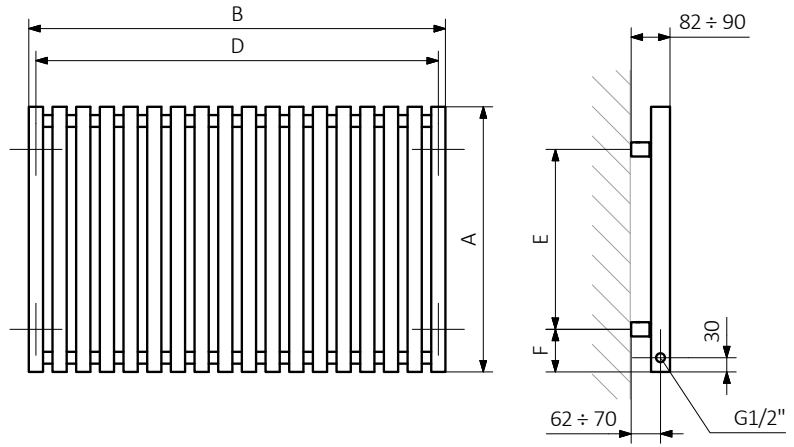

E7

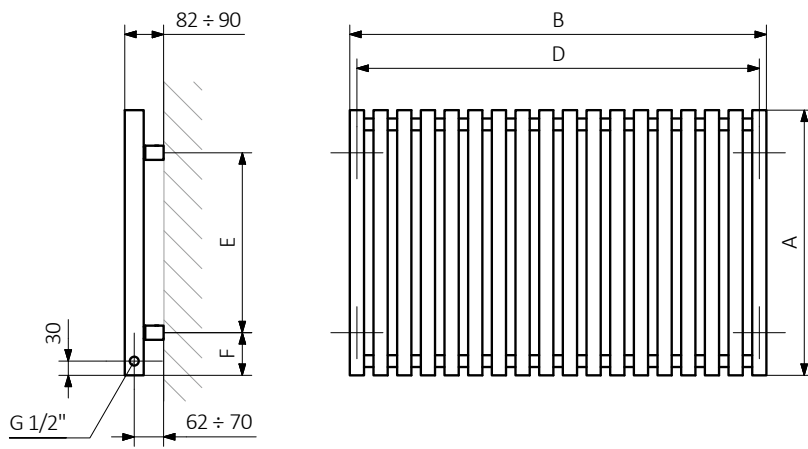



Standard Anschlussstypen:

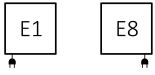

Verfügbare Größen:

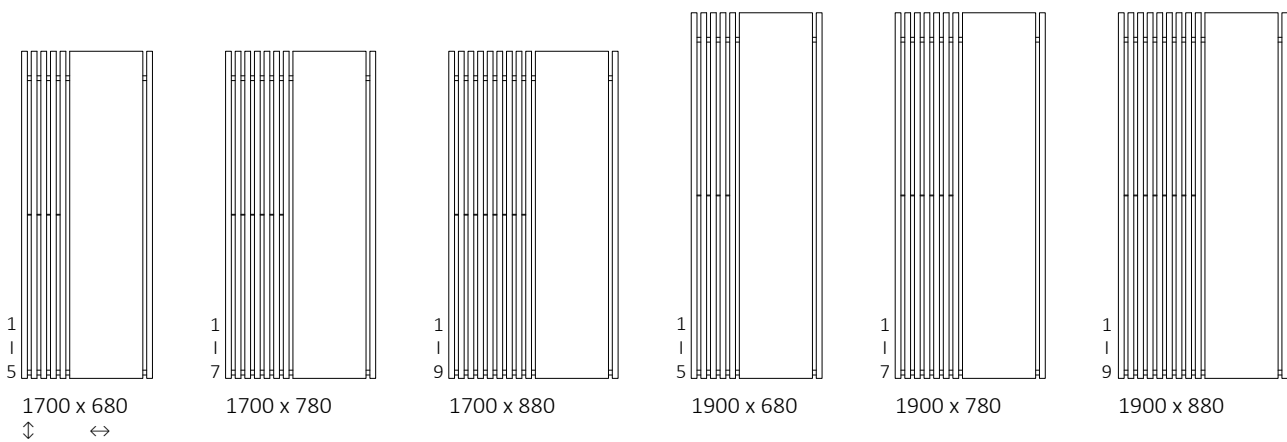

Technische Daten:

A ↓ [mm]	B ↔ [mm]	[W]	D [mm]	E [mm]	F [mm]	H [dm³]	[kg]	Artikelnummer <small>(Konfigurations code s. 664)</small>
1700	680	600	650	1520	90	10,55	37,76	WLTRL170068
1700	780	800	750	1520	90	13,97	46,21	WLTRL170078
1700	880	1000	850	1520	90	17,39	54,65	WLTRL170088
1900	680	800	650	1720	90	11,75	42,01	WLTRL190068
1900	780	1000	750	1720	90	15,57	51,42	WLTRL190078
1900	880	1200	850	1720	90	19,39	60,83	WLTRL190088

Wir empfehlen: Heizpatrone
ONE



Handtuchhalter
ZIP V 40



E1

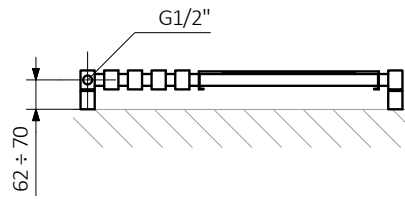

E8

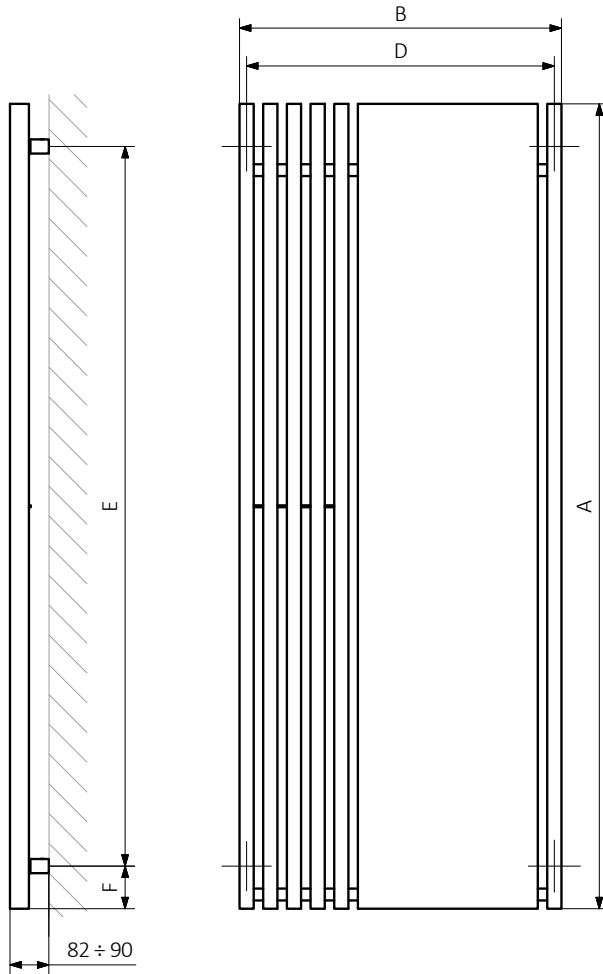
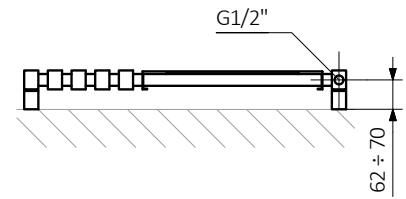

A - Höhe B - Breite C1-C5 - Anschlussabstand D - horizontaler Wandhalterungsabstand E - Vertikaler Wandhalterungsabstand F - Abstand von der Achse der unteren Wandhalterung bis Unterkante des Kollektors

Kollektor:

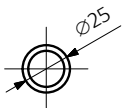

Rohr:

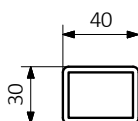



Standard Anschlussstypen:



Verfügbare Größen:

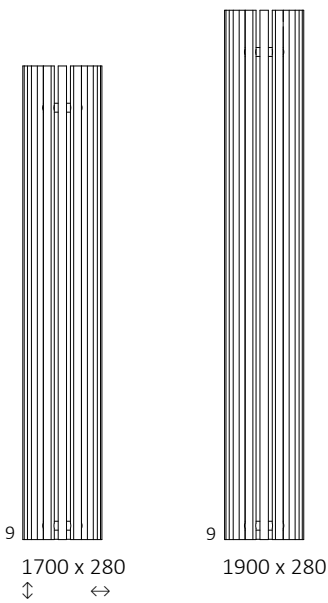

Technische Daten:

A ↓ [mm]	B ↔ [mm]	[W]	D [mm]	E [mm]	F [mm]	[dm³]	[kg]	Artikelnummer <small>(Konfigurations code s. 664)</small>
1700	280	1000	120	1500	50	11,64	32,04	WLV170028
1900	280	1000	120	1700	50	12,95	35,52	WLV190028

Wir empfehlen: Heizpatronen
Steuerung KTX 4



Handtuchhalter
ZIP V 30



EX

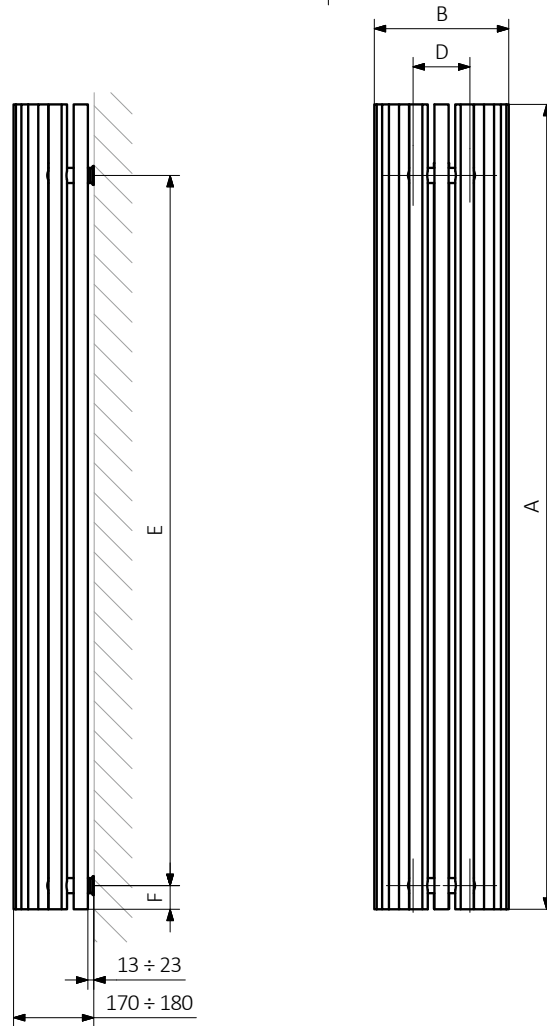
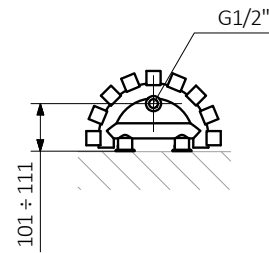

A - Höhe B - Breite C1-C5 - Anschlussabstand D - horizontaler Wandhalterungsabstand E - Vertikaler Wandhalterungsabstand F - Abstand von der Achse der unteren Wandhalterung bis Unterkante des Kollektors

Kollektor:

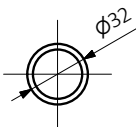

Rohr:

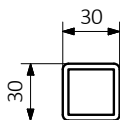



Standard Anschlussstypen:



Verfügbare Größen:

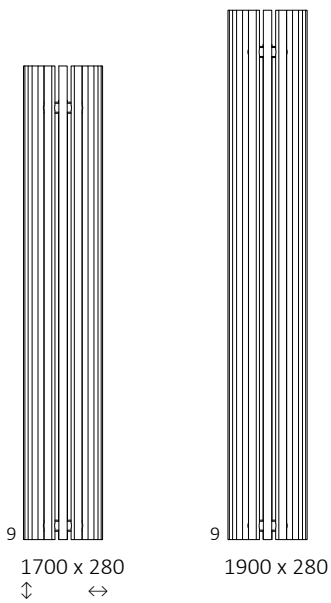

Technische Daten:

A ↓ [mm]	B ↔ [mm]	[W]	D [mm]	E [mm]	F [mm]	[dm³]	[kg]	Artikelnummer <small>(Konfigurationscode s. 664)</small>
1700	280	1000	151	1500	50	11,64	32,04	WLVEC170028
1900	280	1000	151	1700	50	12,95	35,52	WLVEC190028

Wir empfehlen: Heizpatronen
Steuerung KTX 3



Handtuchhalter
ZIP V 30



EX

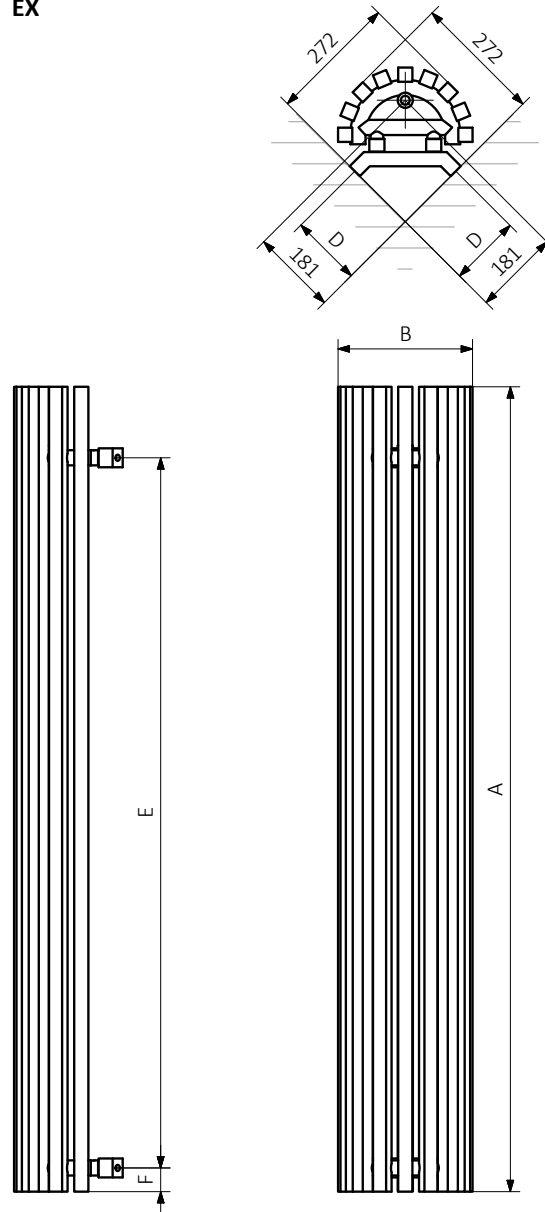

A – Höhe B – Breite C1-C5 – Anschlussabstand D – horizontaler Wandhalterungsabstand E – Vertikaler Wandhalterungsabstand
F – Abstand von der Achse der unteren Wandhalterung bis Unterkante des Kollektors

Kollektor:

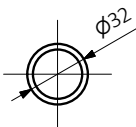

Rohr:

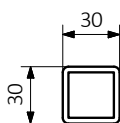



Standard Anschlussstypen:

A ↕ 600:

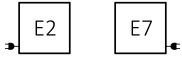

A ↕ 1800:

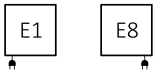

Technische Daten:

A ↕ [mm]	B ↔ [mm]	 [W]	D [mm]	E [mm]	F [mm]	 [dm³]	 [kg]	Artikelnummer <small>(Konfigurations code s. 664)</small>
600	590	800	550	500	50	10,72	24,39	WLTUV060059
600	790	1000	750	500	50	14,30	32,50	WLTUV060079
600	990	1200	950	500	50	17,87	40,60	WLTUV060099
600	1190	1500	1150	500	50	21,45	48,71	WLTUV060119
600	1390	1500	1350	500	50	25,03	56,82	WLTUV060139
1800	290	1000	250	1600	50	15,26	34,07	WLTUV180029
1800	490	1500	450	1600	50	25,44	56,67	WLTUV180049

Wir empfehlen: Heizpatrone
MOA



Verfügbare Größen:

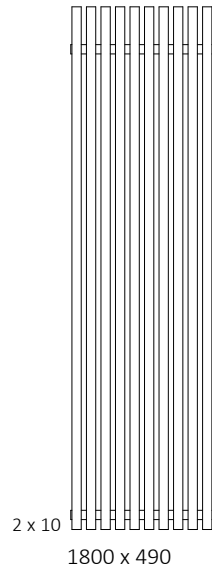
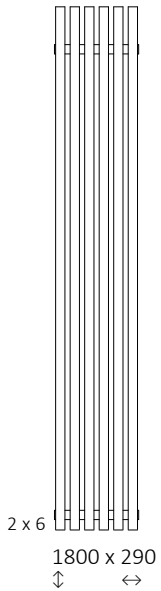
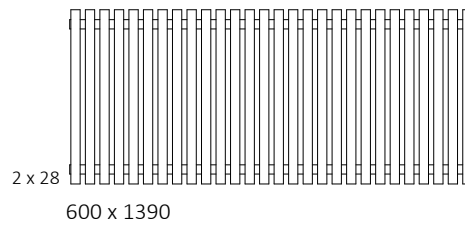
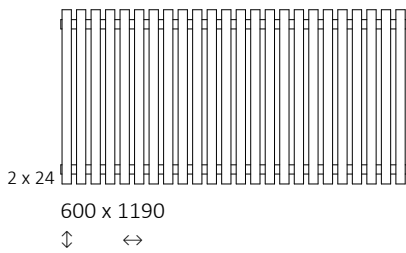
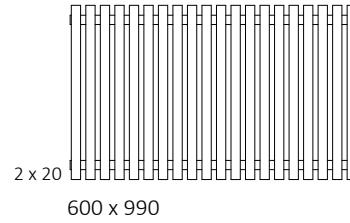
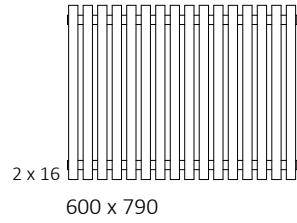
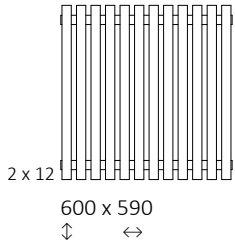

E2

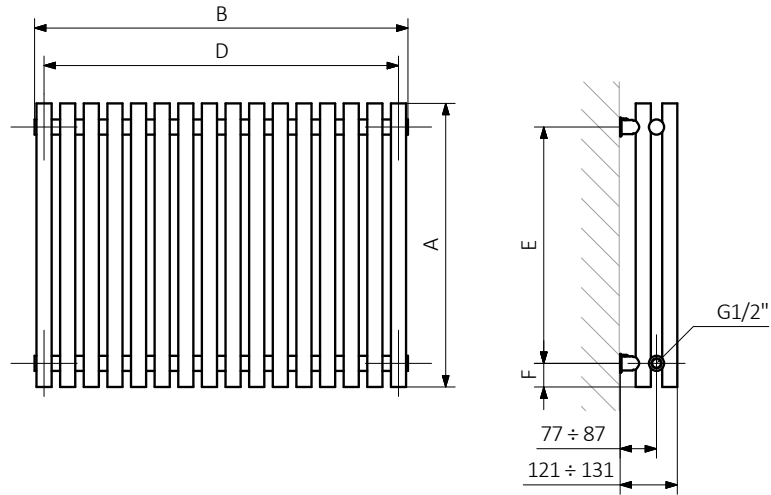

E7

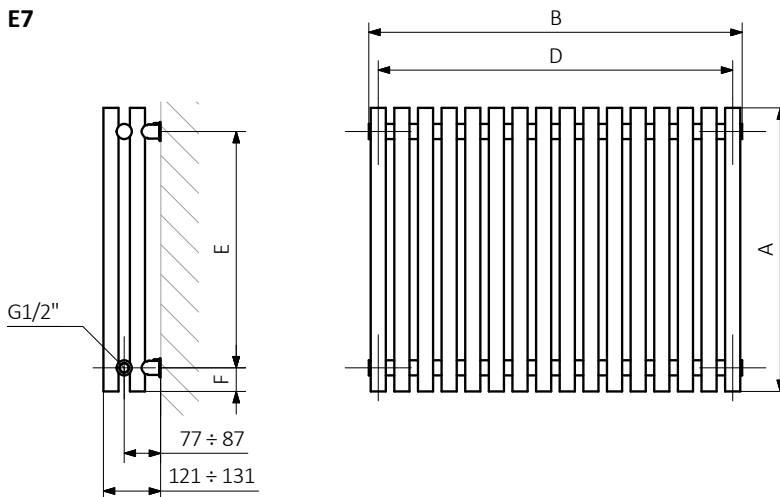

A – Höhe B – Breite C1-C5 – Anschlussabstand D – horizontaler Wandhalterungsabstand E – Vertikaler Wandhalterungsabstand
 F – Abstand von der Achse der unteren Wandhalterung bis Unterkante des Kollektors

Rohr:

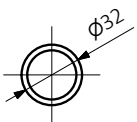

E1

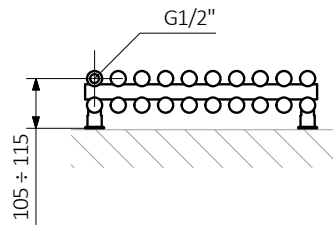

E8

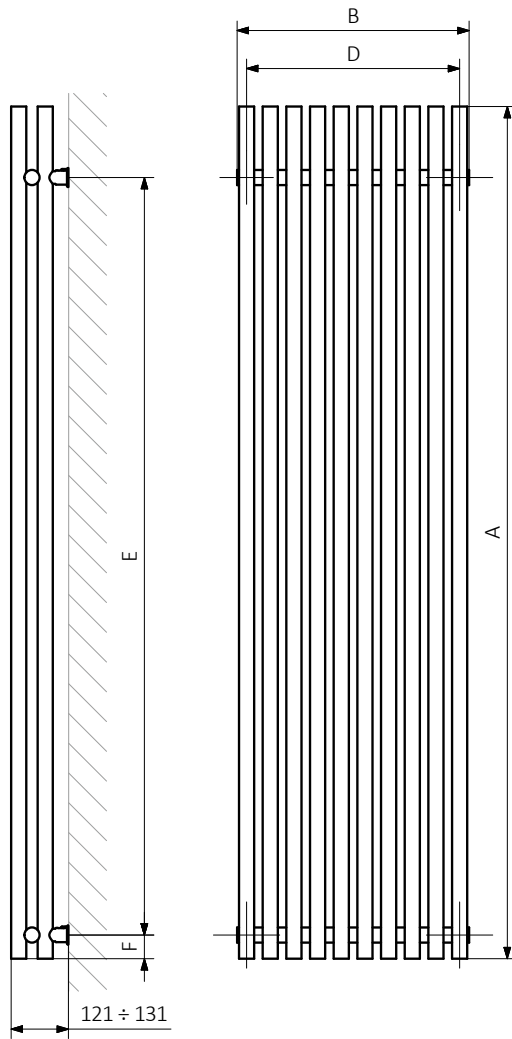
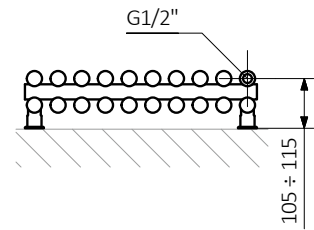



Standard Anschlussstypen:

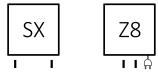

Elektroheizkörper siehe Seite 321

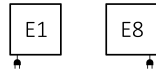

Weitere mögliche Anschlussstypen:

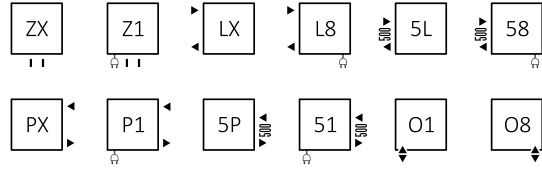

Verfügbare Größen:

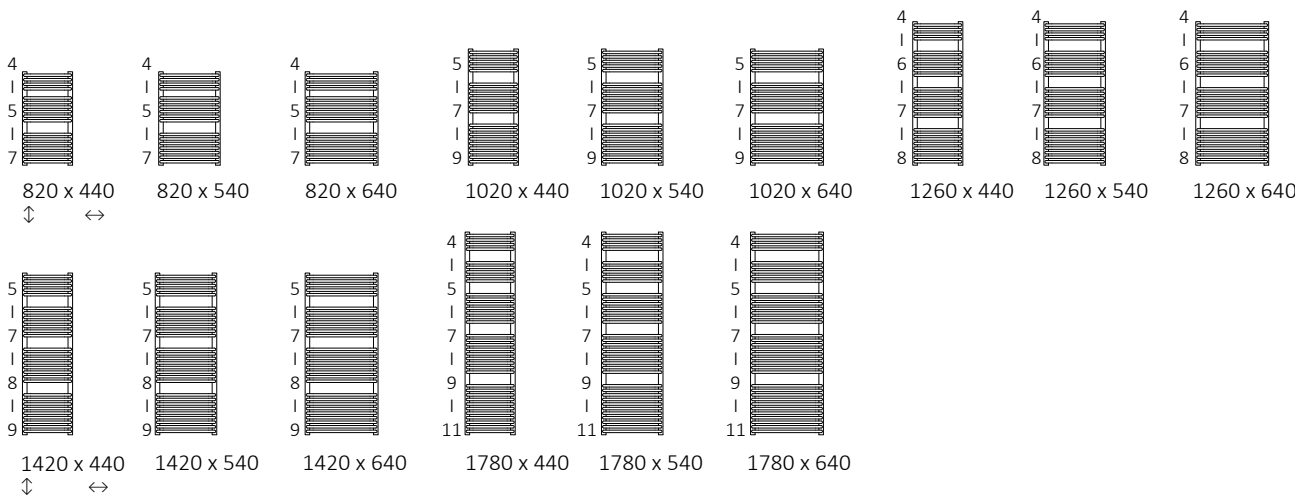

Technische Daten:

Betriebsdruck: 800 kPa

Maximale Betriebstemperatur: 95°C

A ↓ [mm]	B ↔ [mm]	C1 [mm]	C2 [mm]	75/65/20°C [W]	55/45/20°C [W]	☉ [W]	D [mm]	E [mm]	F [mm]	⊞ [dm²]	⚖️ [kg]	Artikelnummer <small>(Konfigurations code s. 662)</small>
820	440	50	400	533	288	600	400	640	90	5,44	12,15	WGTYT082044
820	540	50	500	645	348	600	500	640	90	6,39	14,29	WGTYT082054
820	640	50	600	755	407	800	600	640	90	7,35	16,43	WGTYT082064
1020	440	50	400	666	358	600	400	840	90	7,03	15,67	WGTYT102044
1020	540	50	500	806	433	800	500	840	90	8,29	18,47	WGTYT102054
1020	640	50	600	943	507	1000	600	840	90	9,54	21,28	WGTYT102064
1260	440	50	400	828	444	800	400	1080	90	8,46	18,82	WGTYT126044
1260	540	50	500	1002	537	1000	500	1080	90	9,95	22,16	WGTYT126054
1260	640	50	600	1173	628	1200	600	1080	90	11,44	25,50	WGTYT126064
1420	440	50	400	930	497	1000	400	1240	90	9,73	21,63	WGTYT142044
1420	540	50	500	1126	602	1200	500	1240	90	11,46	25,51	WGTYT142054
1420	640	50	600	1317	704	1200	600	1240	90	13,20	29,38	WGTYT142064
1780	440	50	400	1167	623	1200	400	1600	90	12,11	26,89	WGTYT178044
1780	540	50	500	1412	753	1500	500	1600	90	14,26	31,70	WGTYT178054
1780	640	50	600	1652	881	1500	600	1600	90	16,41	36,51	WGTYT178064

Wir empfehlen: Set Thermostat Verbund-eckventil für Anschluss Z8



Abdeckblende



Heizpatrone
MOA

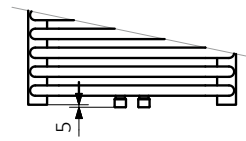
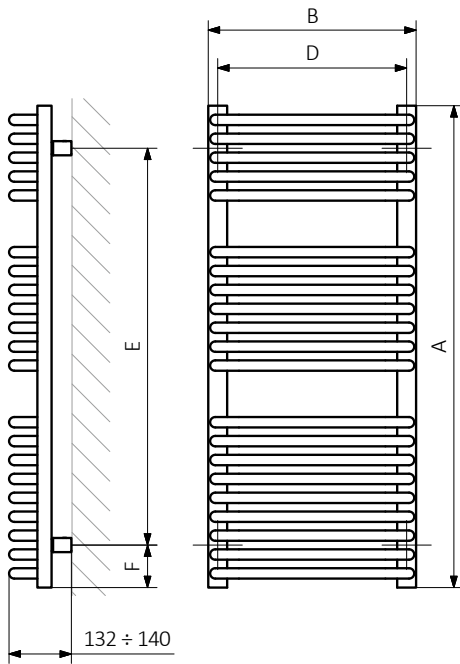
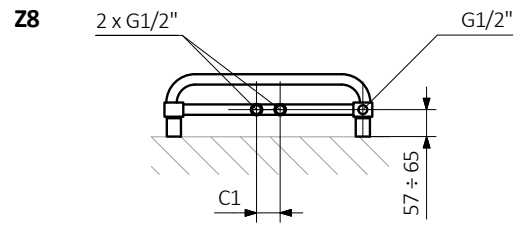
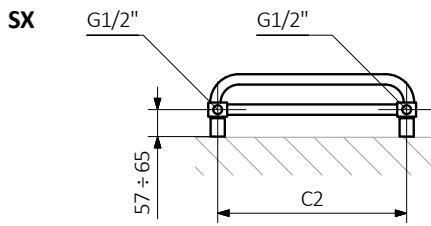

A - Höhe B - Breite C1-C5 - Anschlussabstand D - horizontaler Wandhalterungsabstand E - Vertikaler Wandhalterungsabstand F - Abstand von der Achse der unteren Wandhalterung bis Unterkante des Kollektors

Kollektor:

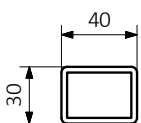

Rohr:

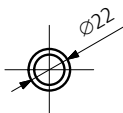



Standard Anschlussstypen:

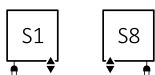

Elektroheizkörper siehe Seite 321

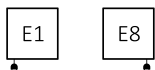

Weitere mögliche Anschlussstypen:

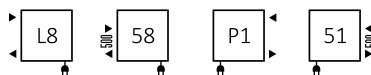

Verfügbare Größen:

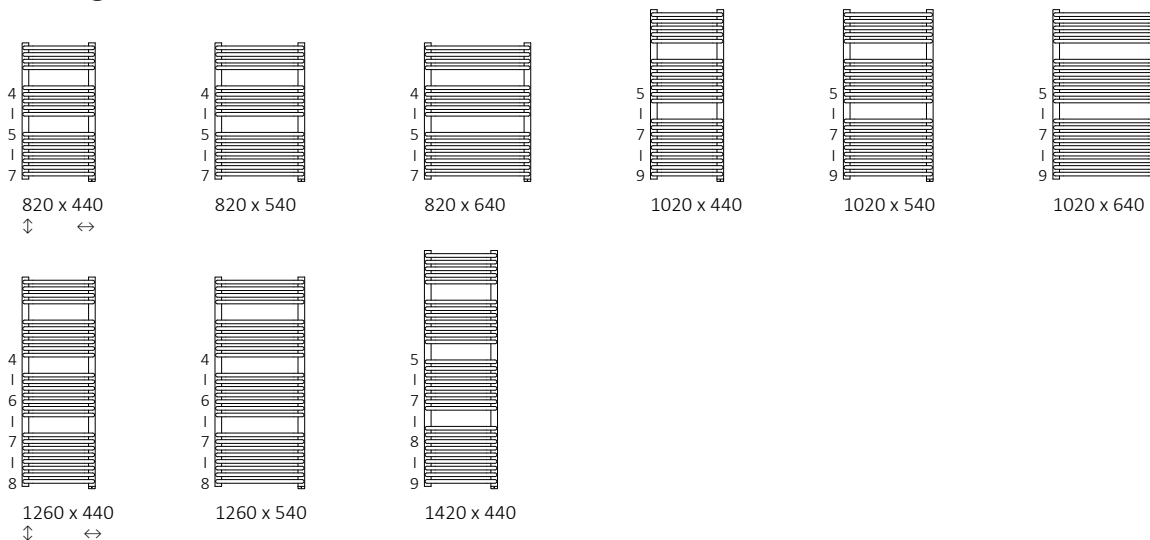

Technische Daten:

Betriebsdruck: 800 kPa

Maximale Betriebstemperatur: 82°C

A ↓ [mm]	B ↔ [mm]	75 65 20°C [W]	55 45 20°C [W]	[W]	D [mm]	E [mm]	F [mm]	 [dm³]	 [kg]	Artikelnummer <small>(Konfigurations code s. 663)</small>
820	440	533	288	600	400	680	70	5,35	12,15	WZTYN082044
820	540	645	348	600	500	680	70	6,31	14,29	WZTYN082054
820	640	755	407	800	600	680	70	7,27	16,43	WZTYN082064
1020	440	666	358	600	400	880	70	6,95	15,67	WZTYN102044
1020	540	806	433	800	500	880	70	8,20	18,47	WZTYN102054
1020	640	943	507	1000	600	880	70	9,46	21,28	WZTYN102064
1260	440	828	444	800	400	1120	70	8,37	18,82	WZTYN126044
1260	540	1002	537	1000	500	1120	70	9,87	22,16	WZTYN126054
1420	440	930	497	1000	400	1280	70	9,65	21,63	WZTYN142044

Wir empfehlen: Set Lanzen-Thermostat-Verbund-eckventil für Anschluss S1 und S8

Abdeckblende

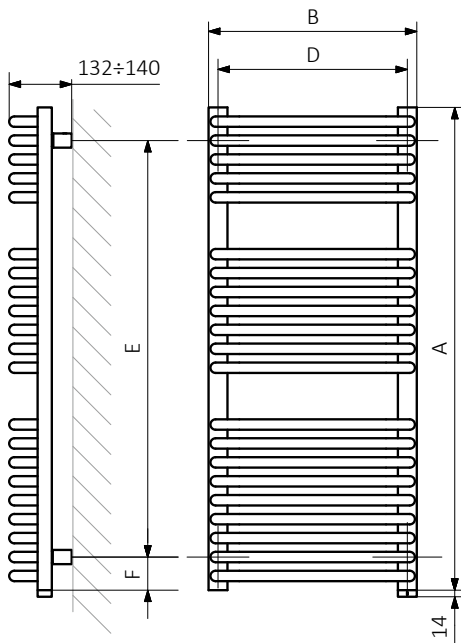
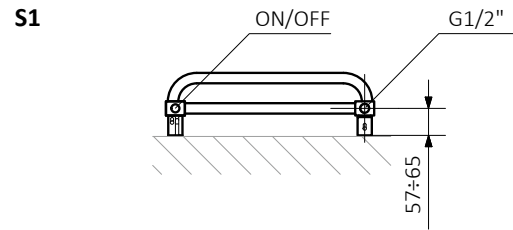
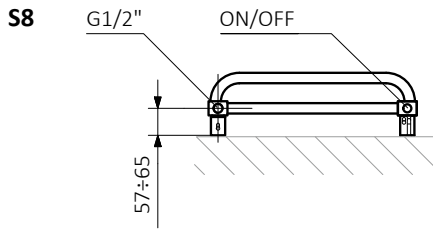

A - Höhe B - Breite C1-C5 - Anschlussabstand D - horizontaler Wandhalterungsabstand E - Vertikaler Wandhalterungsabstand F - Abstand von der Achse der unteren Wandhalterung bis Unterkante des Kollektors

Kollektor:

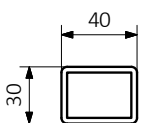

Rohr:

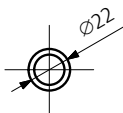



Standard Anschlussstypen:



Elektroheizkörper siehe Seite 321



Verfügbare Größen:

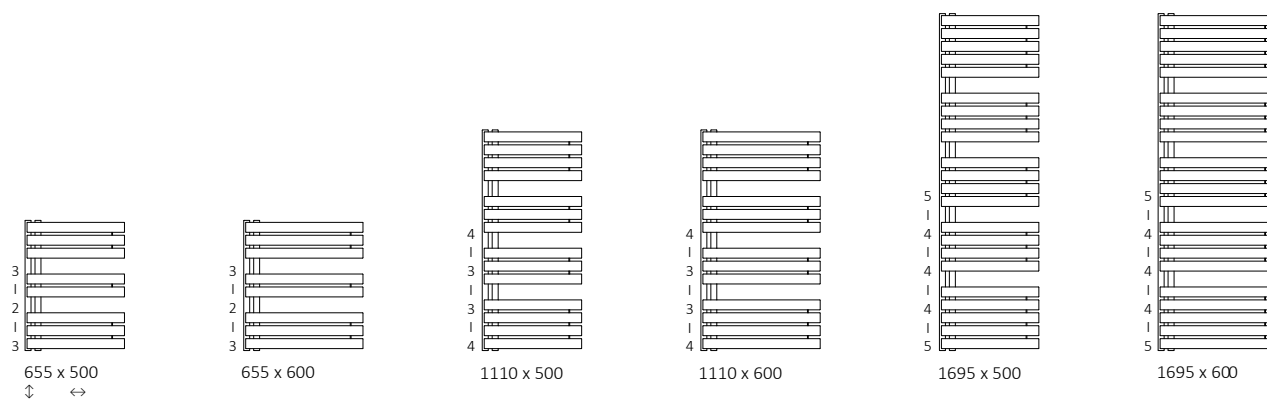

Technische Daten:

Betriebsdruck: 600 kPa

Maximale Betriebstemperatur: 95°C

A ↓ [mm]	B ↔ [mm]	C1 [mm]	75/65/20°C [W]	55/45/20°C [W]	 [W]	D [mm]	E [mm]	F [mm]	 [dm³]	 [kg]	Artikelnummer <small>(Konfigurations code s. 662)</small>
655	500	50	450	241	400	50	455	100	3,45	12,39	WGWAS065050
655	600	50	506	271	600	50	455	100	3,98	14,56	WGWAS065060
1110	500	50	764	406	800	50	910	100	5,99	21,30	WGWAS111050
1110	600	50	857	456	800	50	910	100	6,91	25,10	WGWAS111060
1695	500	50	1167	620	1200	50	1495	100	9,34	33,11	WGWAS169050
1695	600	50	1310	696	1200	50	1495	100	10,79	39,07	WGWAS169060

Wir empfehlen: Set Thermostat Verbunddeckventil mit T-Stück zum Anschluss einer Heizpatrone für Anschluss GD



Abdeckblende

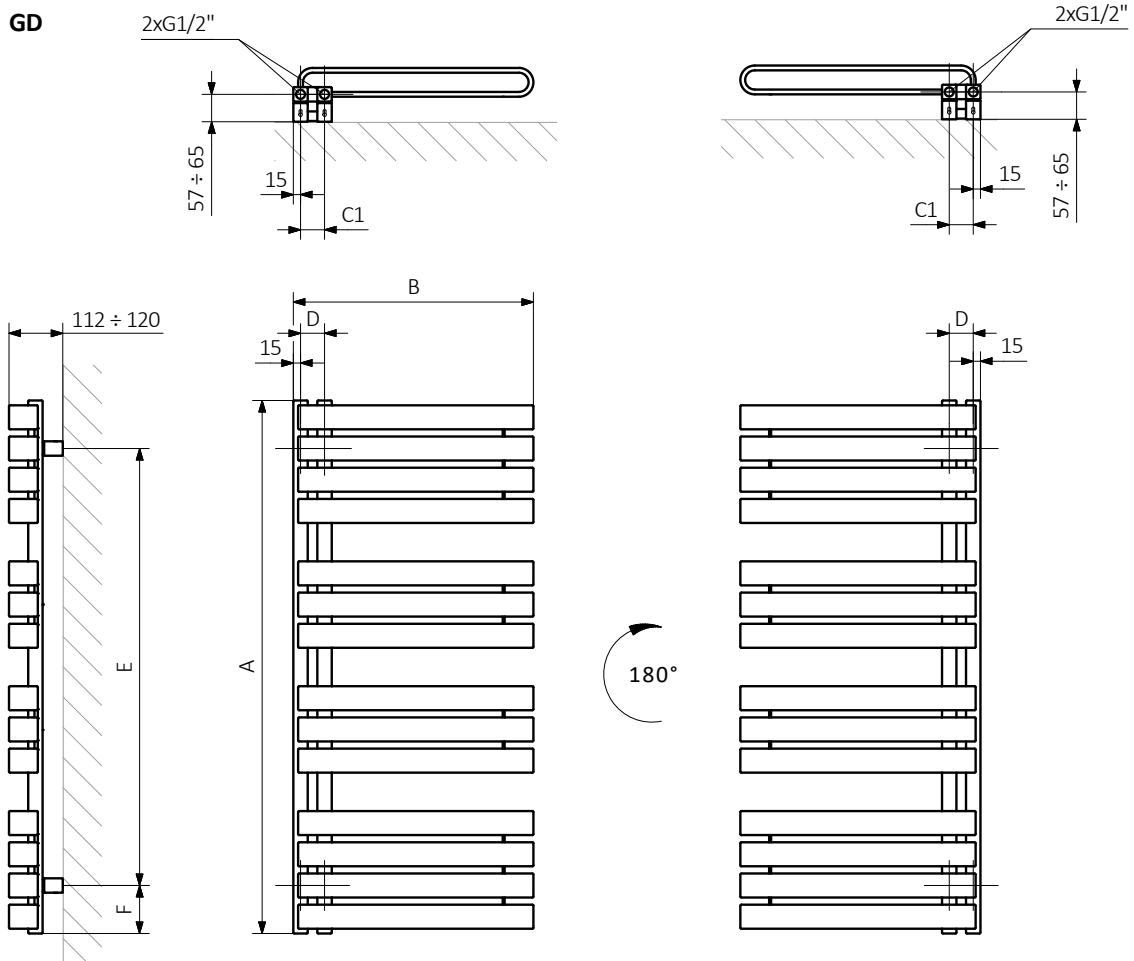

A – Höhe B – Breite C1-C5 – Anschlussabstand D – horizontaler Wandhalterungsabstand E – Vertikaler Wandhalterungsabstand F – Abstand von der Achse der unteren Wandhalterung bis Unterkante des Kollektors

Kollektor:

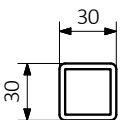

Rohr:

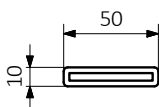



Standard Anschlussstypen:

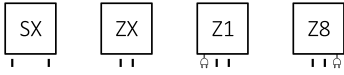

Elektroheizkörper siehe Seite 321

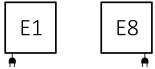

Weitere mögliche Anschlussstypen:

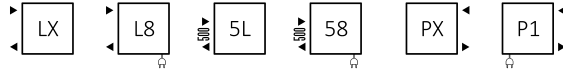

Verfügbare Größen:

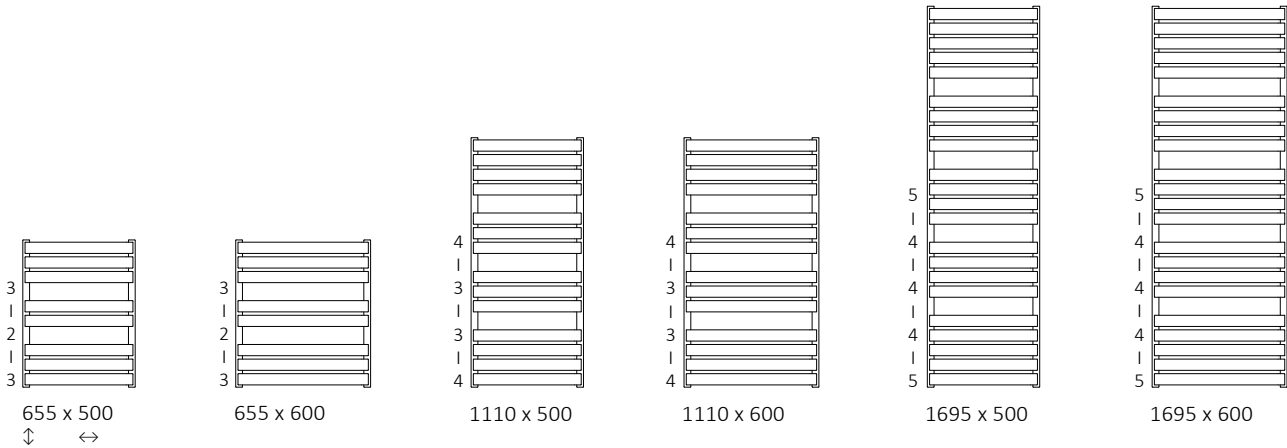

Technische Daten:

Betriebsdruck: 600 kPa

Maximale Betriebstemperatur: 95°C

A ↓ [mm]	B ↔ [mm]	C1 [mm]	C2 [mm]	75/65/20°C [W]	55/45/20°C [W]	[W]	D [mm]	E [mm]	F [mm]	[dm ²]	[kg]	Artikelnummer <small>(Konfigurations code s. 662)</small>
655	500	50	470	325	176	300	470	455	100	2,32	12,33	WGWAT065050
655	600	50	570	383	208	400	570	455	100	2,59	14,45	WGWAT065060
1110	500	50	470	553	298	600	470	910	100	4,02	21,19	WGWAT111050
1110	600	50	570	650	350	600	570	910	100	4,48	24,92	WGWAT111060
1695	500	50	470	846	453	800	470	1495	100	6,24	32,94	WGWAT169050
1695	600	50	570	1000	535	1000	570	1495	100	6,96	38,80	WGWAT169060

Wir empfehlen: Set Thermostat Verbunddeckventil für Anschluss ZX, Z1 und Z8.

Abdeckblende

Heizpatronen Steuerung KTX 3



SX

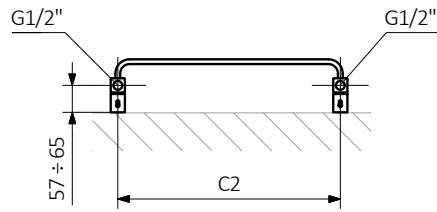

ZX

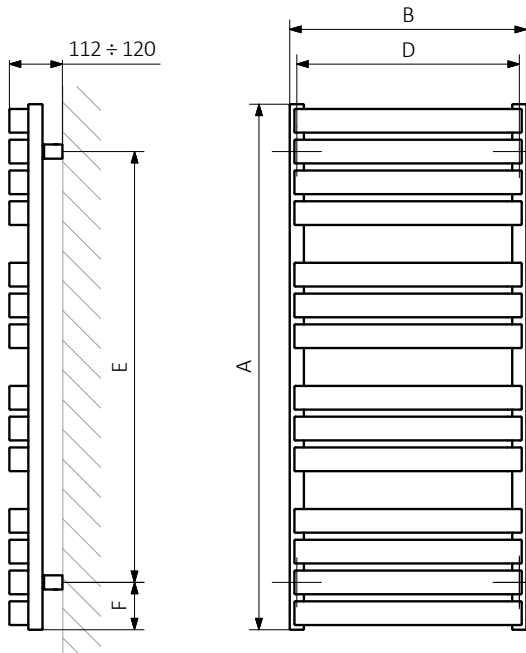
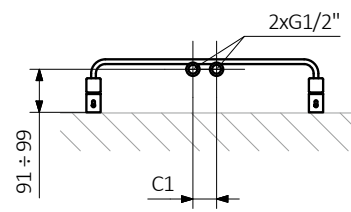

Z1

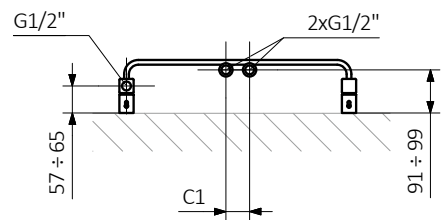

Z8

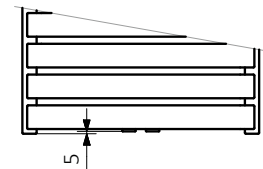
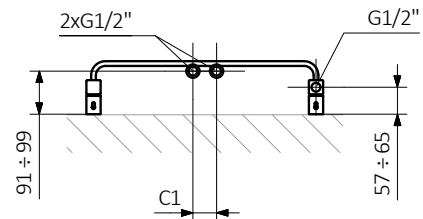

A - Höhe B - Breite C1-C5 - Anschlussabstand D - horizontaler Wandhalterungsabstand E - Vertikaler Wandhalterungsabstand F - Abstand von der Achse der unteren Wandhalterung bis Unterkante des Kollektors

Kollektor:

Rohr:

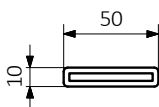
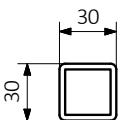

Warp T One

Seite 136



Standard Anschlussstypen:

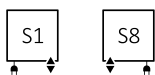

Elektroheizkörper siehe Seite 321

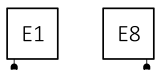

Verfügbare Größen:

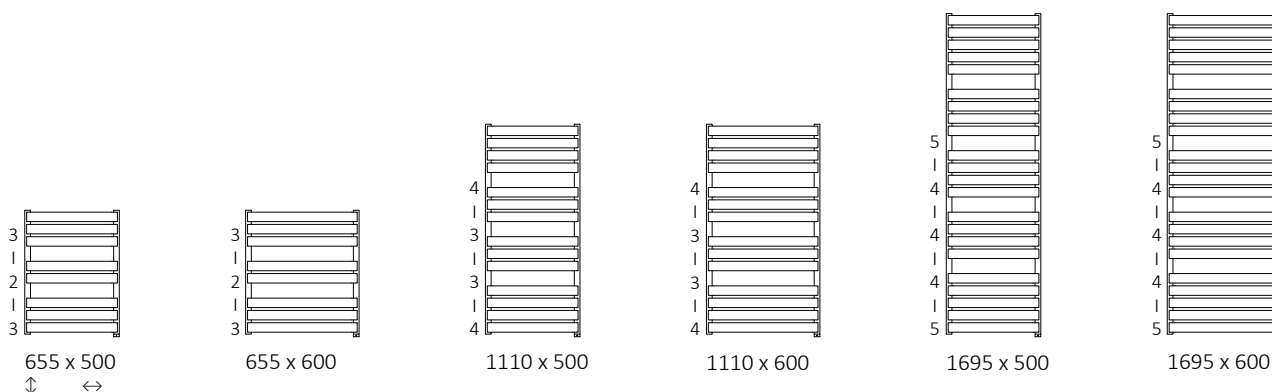

Technische Daten:

Betriebsdruck: 600 kPa

Maximale Betriebstemperatur: 82°C

A ↓ [mm]	B ↔ [mm]	75/65/20°C [W]	55/45/20°C [W]	☉ [W]	D [mm]	E [mm]	F [mm]	⊞ [dm³]	⚖ [kg]	Artikelnummer <small>(Konfigurations code s. 663)</small>
655	500	325	176	300	470	515	70	2,23	12,33	WZW TN065050
655	600	383	208	400	570	515	70	2,50	14,45	WZW TN065060
1110	500	553	298	600	470	970	70	3,93	21,19	WZW TN111050
1110	600	650	350	600	570	970	70	4,39	24,92	WZW TN111060
1695	500	846	453	800	470	1555	70	6,15	32,94	WZW TN169050
1695	600	1000	535	1000	570	1555	70	6,87	38,80	WZW TN169060

Wir empfehlen: Set Lanzen-Thermostat-Verbund-eckventil für Anschluss S1 und S8

Abdeckblende



S8

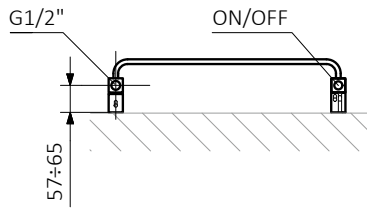

S1

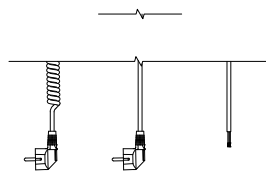
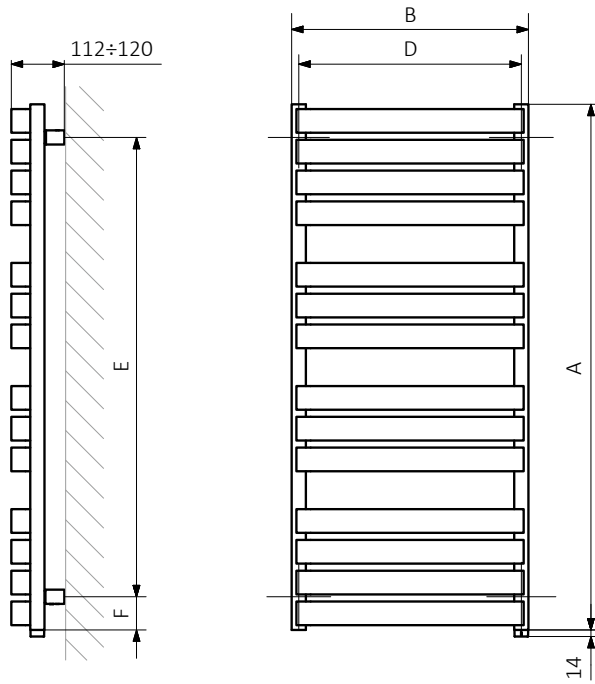
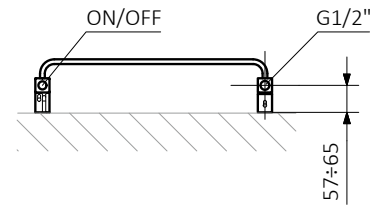

A - Höhe B - Breite C1-C5 - Anschlussabstand D - horizontaler Wandhalterungsabstand E - Vertikaler Wandhalterungsabstand F - Abstand von der Achse der unteren Wandhalterung bis Unterkante des Kollektors

Kollektor:

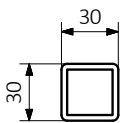

Rohr:

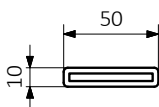



Standard Anschlussstypen:

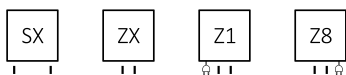

Elektroheizkörper siehe Seite 321

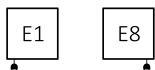

Weitere mögliche Anschlussstypen:

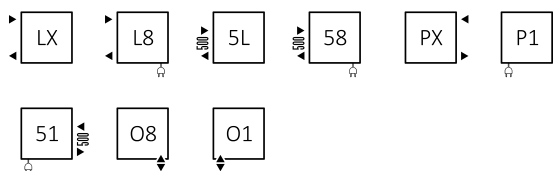

Verfügbare Größen:

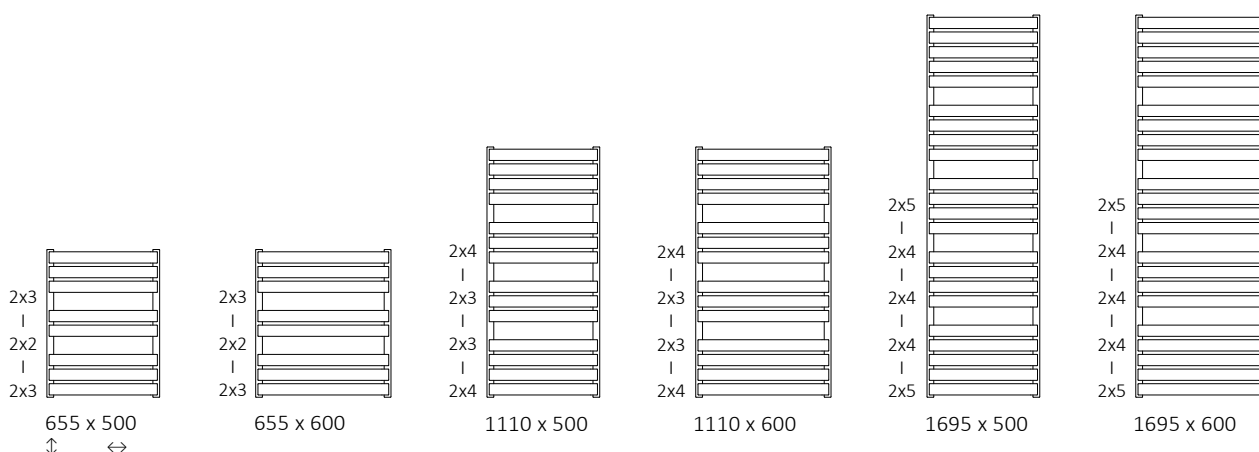

Technische Daten:

Betriebsdruck: 600 kPa

Maximale Betriebstemperatur: 95°C

A ↓ [mm]	B ↔ [mm]	C1 [mm]	C2 [mm]	75/65/20°C [W]	55/45/20°C [W]	☉ [W]	D [mm]	E [mm]	F [mm]	H [dm ²]	G [kg]	Artikelnummer <small>(Konfigurations code s. 662)</small>
655	500	50	470	460	249	400	470	455	100	3,48	12,40	WGWTB065050
655	600	50	570	545	294	600	570	455	100	4,00	14,56	WGWTB065060
1110	500	50	470	780	419	800	470	910	100	6,04	21,30	WGWTB111050
1110	600	50	570	924	491	1000	570	910	100	6,96	25,10	WGWTB111060
1695	500	50	470	1190	636	1200	470	1495	100	9,42	33,12	WGWTB169050
1695	600	50	570	1410	746	1500	570	1495	100	10,86	39,09	WGWTB169060

Wir empfehlen: Set Thermostat Verbundventil für Anschluss ZX, Z1 und Z8.

Abdeckblende

Heizpatronen
Steuerung KTX 4



SX

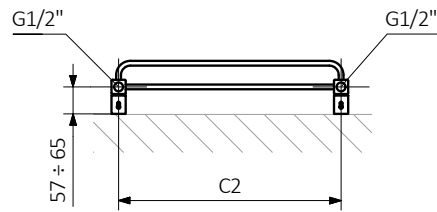

ZX

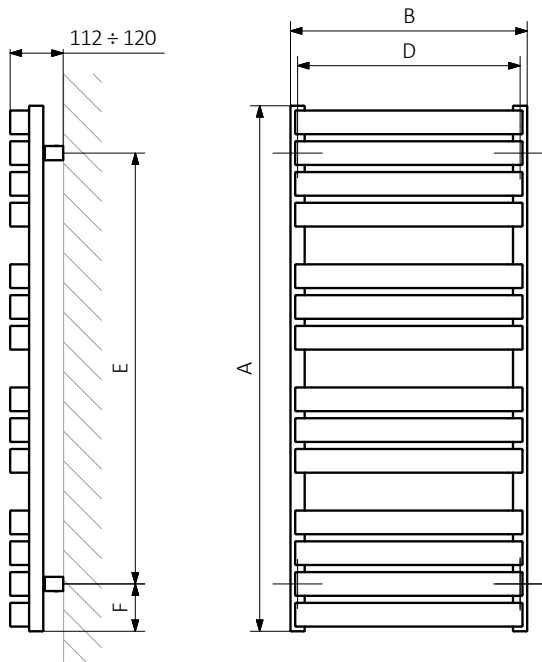
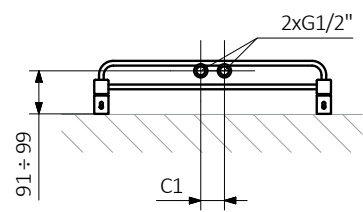

Z1

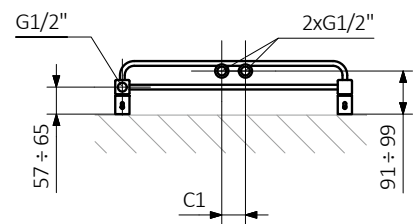

Z8

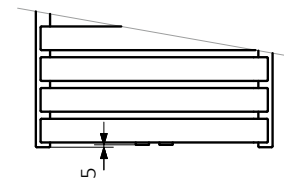
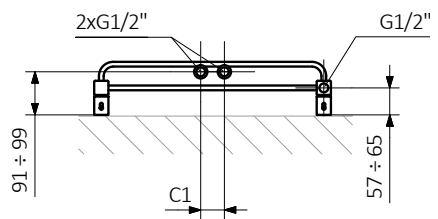

A - Höhe B - Breite C1-C5 - Anschlussabstand D - horizontaler Wandhalterungsabstand E - Vertikaler Wandhalterungsabstand F - Abstand von der Achse der unteren Wandhalterung bis Unterkante des Kollektors

Kollektor:

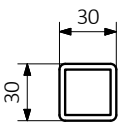

Rohr:

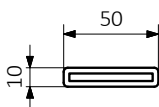



Standard Anschlussarten:

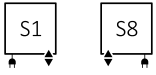

Elektroheizkörper siehe Seite 321

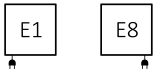

Verfügbare Größen:

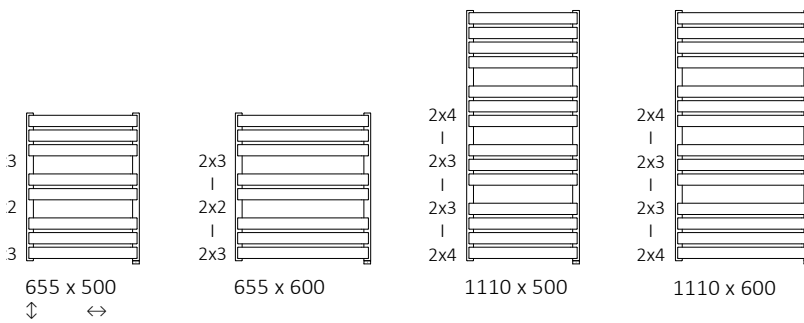

Technische Daten:

Betriebsdruck: 600 kPa

Maximale Betriebstemperatur: 82°C

A ↓ [mm]	B ↔ [mm]	75/65/20°C [W]	55/45/20°C [W]	☉ [W]	D [mm]	E [mm]	F [mm]	U [dm³]	⚖️ [kg]	Artikelnummer <small>(Konfigurationscode s. 663)</small>
655	500	460	249	400	470	515	70	3,48	12,40	WZWBN065050
655	600	545	294	600	570	515	70	4,00	14,56	WZWBN065060
1110	500	780	419	800	470	970	70	6,04	21,30	WZWBN111050
1110	600	924	491	1000	570	970	70	6,96	25,10	WZWBN111060

Wir empfehlen: Set Lanzen-Thermostat-Verbundventil für Anschluss S1 und S8

Abdeckblende



S8

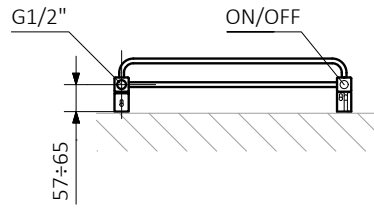

S1

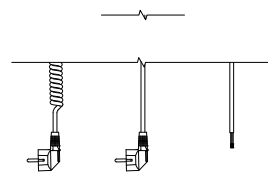
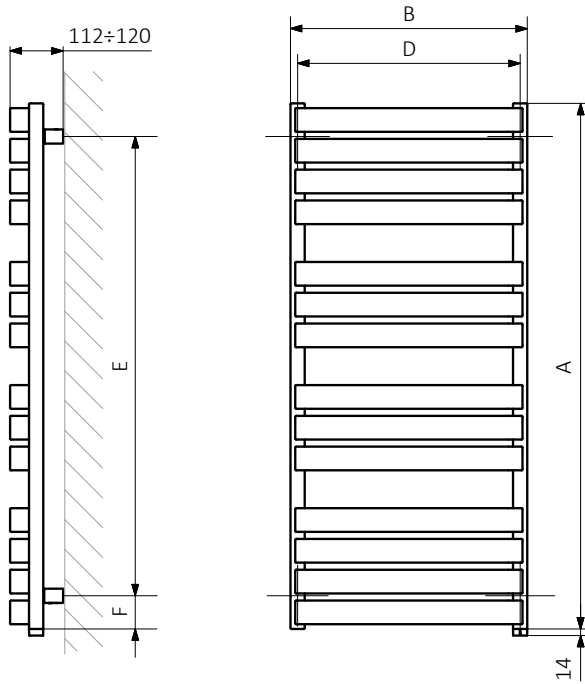
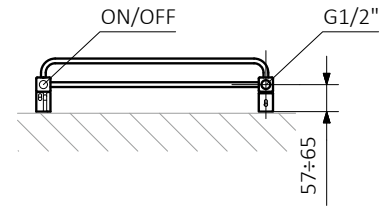

A – Höhe B – Breite C1-C5 – Anschlussabstand D – horizontaler Wandhalterungsabstand E – Vertikaler Wandhalterungsabstand F – Abstand von der Achse der unteren Wandhalterung bis Unterkante des Kollektors

Kollektor:

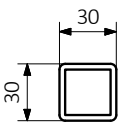

Rohr:

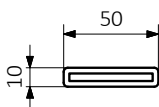



Standard Anschlussstypen:

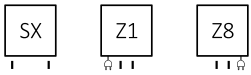

Elektroheizkörper siehe Seite 321

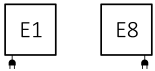

Weitere mögliche Anschlussstypen:

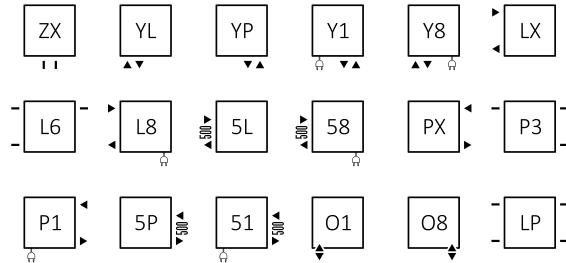

Verfügbare Größen:

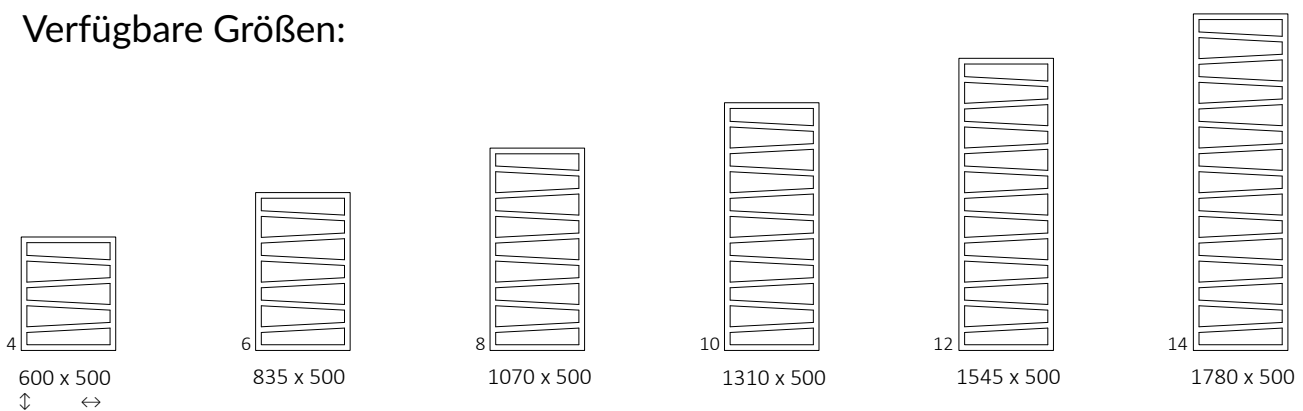

Technische Daten:

Betriebsdruck: 1000 kPa Maximale Betriebstemperatur: 95°C

A ↓ [mm]	B ↔ [mm]	C1 [mm]	C2 [mm]	75/65/20°C [W]	55/45/20°C [W]	Ⓢ [W]	D [mm]	E [mm]	F [mm]	Ⓜ [dm ²]	Ⓢ [kg]	Artikelnummer <small>(Konfigurations code s. 662)</small>
Pulverlack												
600	500	50	470	248	134	300	470	420	90	2,77	5,07	WGZIG060050
835	500	50	470	320	172	300	470	655	90	3,74	6,86	WGZIG083050
1070	500	50	470	406	218	400	470	890	90	4,72	8,64	WGZIG107050
1310	500	50	470	490	263	600	470	1130	90	5,70	10,44	WGZIG131050
1545	500	50	470	581	311	600	470	1365	90	6,67	12,23	WGZIG154050
1780	500	50	470	627	335	600	470	1600	90	7,65	14,01	WGZIG178050
Galvanische Oberfläche												
600	500	50	470	174	94	200	470	420	90	2,77	4,90	WGZIG060050
835	500	50	470	224	120	200	470	655	90	3,74	6,60	WGZIG083050
1070	500	50	470	284	153	300	470	890	90	4,72	8,40	WGZIG107050
1310	500	50	470	343	184	400	470	1130	90	5,70	10,10	WGZIG131050
1545	500	50	470	407	218	400	470	1365	90	6,67	11,80	WGZIG154050
1780	500	50	470	439	235	400	470	1600	90	7,65	13,50	WGZIG178050

Wir empfehlen: Set Thermostat Verbunddeck-
ventil für Anschluss ZX und Z8



Abdeckblende



Heizpatrone
ONE

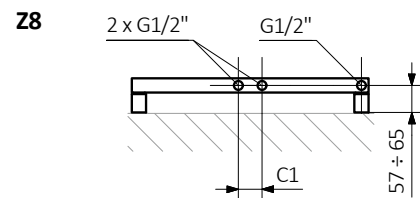
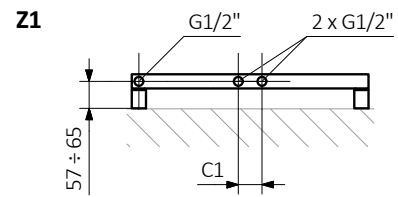
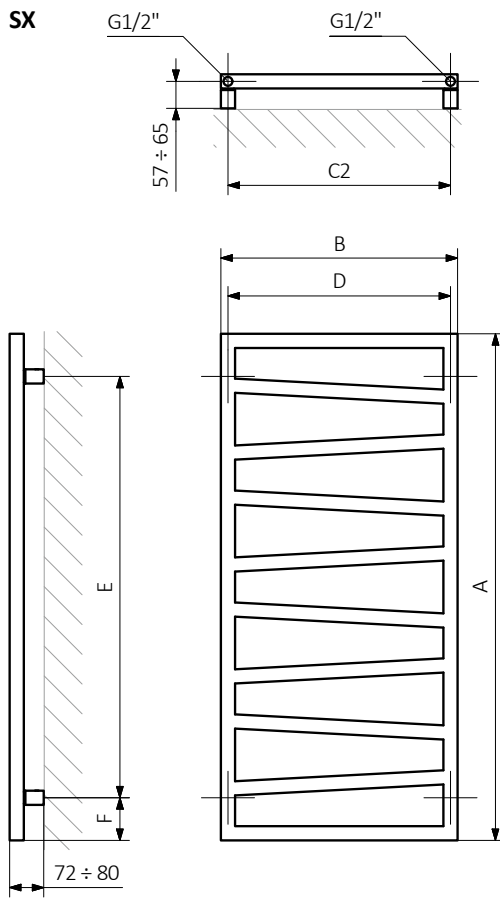

A – Höhe B – Breite C1-C5 – Anschlussabstand D – horizontaler Wandhalterungsabstand E – Vertikaler Wandhalterungsabstand
F – Abstand von der Achse der unteren Wandhalterung bis Unterkante des Kollektors

Rohr:

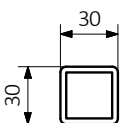

Ungefähre Installationsparameter

Sollte die Installation mit anderen Parametern arbeiten als denen in der Tabelle angegebenen Leistungen oder haben wir eine andere Raumtemperatur als 20°C, müssen wir Korrekturfaktoren verwenden um eine ordnungsgemäße Berechnung der Heizleistung ermöglichen zu können (nächste Seite).

Art der Wärmequelle	Parameter	voraussichtlicher Einsatzort
Zentralheizung	90/70/20°C	Wohnung in altem Wohnblock
Zentralheizung	75/65/20°C	Wohnung in modernem Wohnblock
Festbrennstoffkessel	90/70/20°C	Einfamilienhaus
Gas- / Ölkessel	75/65/20°C	Einfamilienhaus
Kondensationskessel	55/45/20°C	Einfamilienhaus
Wärmepumpe	42/28/20°C	Einfamilienhaus
Brennwertheizung	70/55/20°C	Einfamilienhaus

Raumtemperatur

Die Raumtemperatur hat einen direkten Einfluss auf die Leistungsfähigkeit unseres Körpers. Die Aufrechterhaltung der nach unseren Bedürfnissen eingestellten Innentemperatur im Raum erlaubt es uns nicht nur die Menge Energie zu nutzen, die wir wirklich brauchen, aber sie sorgt vor allem dafür, dass wir uns spürbar wohler fühlen. Es ist bekannt, dass die Temperatur an den individuellen Lebensstil ebenso wie den Raumcharakter angepasst werden sollte. Zum Beispiel in Wohnräumen sollte die Temperatur 21°C nicht überschreiten, in der Küche – wo die Tempe-

ratur während des Kochens steigt – 19-20°C. In zu warmen Räumen kann man sich nicht erholen, daher sollte im Schlafzimmer eine Temperatur von 17-19°C eingestellt werden. Im Badezimmer sollte es am wärmsten sein – bis zu 25°C – da es keiner von uns mag aus der heißen Wanne in ein kaltes Zimmer zu steigen. Nachfolgend schlagen wir eine dem Charakter des Raums angepasste Temperatur vor. Die angegebenen Temperaturen sind lediglich empfohlene Werte.

Wohnzimmer	20-21°C
Schlafzimmer	17-19°C
Kinderzimmer	20-21°C
Badezimmer	22-25°C
Küche	19°C
Haushaltsraum, Vorratsraum, Waschküche	12-15°C

Leistungsfähigkeit und Auswahl von Heizkörpern

Die Leistungsfähigkeit der Heizkörper in den Tabellen dieses Kataloges werden für die Parameter 75/65/20°C und 55/45/20°C (Vorlauftemperatur / Rücklauftemperatur / Lufttemperatur im Raum) angegeben. Um eine geeignete Heizung für den auszustattenden Raum auszuwählen, muss man eine Wärmebilanz nach den geltenden Normen erstellen. Zur Berechnung des Wärmebedarfs für den Raum können folgende Regeln angewendet werden:

- Für Räume und Vorräume in Standard-Gebäuden mit einer Raumhöhe von 2,6 m und einer Raumtemperatur von 20°C schlagen wir 70-80 W/m² vor. Falls der Raum mehr als ein Fenster oder mehr als eine Außenwand hat sollten 80-100 W/m² veranschlagt werden.

- Für Badezimmer in Standard-Gebäuden mit einer Raumhöhe von 2,6 m und einer Raumtemperatur von 24°C schlagen wir 100-120 W/m² vor. Falls im Badezimmer ein Fenster vorhanden sein sollte oder eine Wand eine Außenwand ist, sollten 130-150 W/m² angenommen werden. Die angegebenen Zahlen sind geschätzte Werte. Um den genauen Leistungsbedarf des Raumes zu bestimmen, sollten Sie die entsprechenden Daten vom Hausverwalter einholen. Diese sind bei Planung der sanitären Anlagen zu berücksichtigen, ansonsten sollte der Projektverantwortliche mit entsprechenden Messungen beauftragt werden.

Beispiel:

Raum: Badezimmer, Grundfläche S=5 m² Höhe 2,6 m mit einem Fenster

Angenommener Richtwert
 $q = 140 \text{ W/m}^2$

Den benötigten Wärmebedarf für den Raum Q berechnen wir wie folgt:

$$Q = S \times q$$

$$Q = 5 \times 140 \text{ W/m}^2$$

$$Q = 700 \text{ W}$$

Der geschätzte Wärmebedarf für den o.g. Raum beträgt ca. 700 W.

Tabelle der Korrekturfaktoren

Die Tabelle der Korrekturfaktoren dient zur Berechnung von Heizleistungen für andere Parameter als 75/65/20°C.

Beispiel:

Der berechnete Wärmebedarf für einen vorgegebenen Raum beträgt 1120 W. Der Installationsentwurf enthält folgende Parameter:

Vorlauftemperatur $T_z = 70^\circ\text{C}$

Rücklauftemperatur $T_p = 55^\circ\text{C}$

Raumtemperatur $T_i = 24^\circ\text{C}$

Für diese Parameter entnehmen wir den Faktor aus der nachfolgenden Tabelle $k = 1,42$. Durch Multiplikation des benötigten Wärmebedarfs (1120 W) mit dem abgelesenen Faktor k , erhält man den Wert

1590 W. Mit diesem Wert können wir einen Heizkörper für die Kenn-daten 75/65/20°C aus dem Katalog auswählen.

Zusammenfassend gesagt: Um die Heizleistung von 1120 W bei den „niedrigeren“ Netzparametern (im Beispiel: 70/55/24°C) zu erhalten, muss man eine Heizung wählen, die bei den „höheren“ Parametern (75/65/20°C) eine Leistung von 1590 W hat.



Wir möchten Sie auch auf unser Webportal hinweisen. Hier haben Sie die Möglichkeit schnell und einfach die benötigte Wärmeleistung zu ermitteln und mit Hilfe der gewünschten Eigenschaften und der technischen Parameter einen passenden Heizkörper auszuwählen. Ein Filtertool sorgt für eine einfache und schnelle Auswahl der Produkte, die Ihren Wünschen entsprechen.



Tz [°C]	Tp [°C]	Ti [°C]					
		5	8	12	16	20	24
95	85	0.50	0.52	0.56	0.60	0.64	0.70
	80	0.52	0.55	0.59	0.63	0.68	0.73
	75	0.54	0.57	0.61	0.66	0.72	0.78
	70	0.57	0.60	0.65	0.70	0.76	0.83
90	80	0.54	0.57	0.61	0.66	0.71	0.77
	75	0.57	0.60	0.64	0.69	0.75	0.82
	70	0.59	0.63	0.67	0.73	0.80	0.87
	65	0.62	0.66	0.71	0.78	0.85	0.94
85	75	0.59	0.62	0.67	0.72	0.79	0.86
	70	0.62	0.65	0.71	0.77	0.84	0.92
	65	0.65	0.69	0.75	0.81	0.89	0.99
	60	0.69	0.73	0.79	0.87	0.96	1.07
80	70	0.64	0.68	0.74	0.81	0.88	0.97
	65	0.68	0.72	0.78	0.86	0.94	1.05
	60	0.72	0.76	0.83	0.92	1.02	1.14
	55	0.76	0.81	0.89	0.99	1.10	1.24
75	65	0.71	0.75	0.82	0.90	1.00	1.12
	60	0.75	0.80	0.88	0.97	1.08	1.21
	55	0.80	0.85	0.94	1.04	1.17	1.33
	50	0.85	0.91	1.01	1.13	1.29	1.48
70	60	0.79	0.84	0.93	1.03	1.15	1.30
	55	0.84	0.90	0.99	1.11	1.25	1.42
	50	0.89	0.96	1.07	1.21	1.37	1.59
	45	0.96	1.04	1.17	1.33	1.53	1.80
65	60	0.83	0.89	0.98	1.10	1.23	1.40
	55	0.88	0.95	1.05	1.18	1.34	1.54
	50	0.94	1.02	1.14	1.29	1.48	1.72
60	55	0.93	1.01	1.13	1.27	1.45	1.68
	50	1.00	1.08	1.22	1.39	1.60	1.88
	45	1.08	1.17	1.33	1.53	1.79	2.14
55	50	1.07	1.16	1.31	1.50	1.75	2.07
	45	1.15	1.26	1.43	1.66	1.96	2.37
	40	1.25	1.38	1.59	1.87	2.25	2.80
50	45	1.23	1.35	1.56	1.82	2.17	2.67
	40	1.34	1.49	1.73	2.05	2.50	3.16
	35	1.48	1.65	1.95	2.37	2.98	3.96
45	40	1.45	1.62	1.90	2.28	2.83	3.66
	35	1.60	1.80	2.15	2.64	3.38	4.61



Tz – Vorlauftemperatur Tp – Rücklauftemperatur im beheizten Zimmer Ti – Raumtemperatur im beheizten Raum



Elektro-Heizkörper



Pulverlack



Modell	A ↓	B ↔	 [W]	 [dm ³]	 [kg]	Artikelnummer <small>(Konfigurations code s. 664)</small>
ALEX	540	300	200	1,75	4,99	WLALE054030
ALEX	540	400	200	2,04	5,86	WLALE054040
ALEX	540	500	300	2,32	6,73	WLALE054050
ALEX	540	600	400	2,60	7,60	WLALE054060
ALEX	760	300	300	2,46	6,94	WLALE076030
ALEX	760	400	300	2,85	8,16	WLALE076040
ALEX	760	500	400	3,25	9,38	WLALE076050
ALEX	760	600	600	3,65	10,59	WLALE076060
ALEX	1140	300	400	3,78	10,62	WLALE114030
ALEX	1140	400	400	4,41	12,54	WLALE114040
ALEX	1140	500	600	5,03	14,45	WLALE114050
ALEX	1140	600	800	5,65	16,37	WLALE114060
ALEX	1580	500	800	6,90	19,75	WLALE158050
ALEX	1580	600	1000	7,75	22,36	WLALE158060
ALEX	1580	700	1000	8,60	24,97	WLALE158070
ALEX	1580	800	1200	9,45	27,59	WLALE158080
ALEX ONE	760	300	300	2,39	6,94	WWALN076030
ALEX ONE	760	400	300	2,79	8,16	WWALN076040
ALEX ONE	760	500	400	3,19	9,38	WWALN076050
ALEX ONE	760	600	600	3,58	10,59	WWALN076060
ALEX ONE	1140	300	400	3,72	10,62	WWALN114030
ALEX ONE	1140	400	400	4,34	12,54	WWALN114040
ALEX ONE	1140	500	600	4,97	14,45	WWALN114050
ALEX ONE	1140	600	800	5,59	16,37	WWALN114060
ALEX ONE	1580	500	800	6,83	19,75	WWALN158050
ALEX ONE	1580	600	1000	7,68	22,36	WWALN158060
ALEX ONE	1580	700	1000	8,53	25,66	WWALN158070
ANGUS V E	1140	360	400	5,18	15,7	WLANG114036
ANGUS V E	1300	440	600	6,92	21,0	WLANG130044
ANGUS V E	1460	520	800	8,88	26,9	WLANG146052
ANGUS V E	1620	600	1000	11,07	33,5	WLANG162060
ANGUS V E	1780	680	1200	13,48	40,8	WLANG178068
ANGUS H	360	1140	400	5,18	15,70	WLANH036114
ANGUS H	440	1300	600	6,92	20,97	WLANH044130
ANGUS H	520	1460	800	8,88	26,90	WLANH052146
ANGUS H	600	1620	800	11,07	33,54	WLANH060162
ANGUS H	680	1780	1000	13,48	40,84	WLANH068178
BONE	760	500	300	3,09	9,84	WLBON076050
BONE	760	600	400	3,46	11,27	WLBON076060
BONE	1260	500	600	4,93	15,44	WLBON126050
BONE	1260	600	600	5,51	17,65	WLBON126060
BONE	1510	500	600	5,92	18,48	WLBON151050
BONE	1510	600	800	6,61	21,13	WLBON151060
BONE DW	1610	500	600	5,92	18,48	WLBSD161050
BONE DW	1910	500	800	7,24	22,66	WLBSD191050
BONE ONE	760	500	300	2,99	9,76	WWBNN076050
BONE ONE	760	600	400	3,37	11,20	WWBNN076060
BONE ONE	1260	500	600	4,84	15,37	WWBNN126050



Modell	A ↓	B ↔	 [W]	 [dm²]	 [kg]	Artikelnummer <small>(Konfigurations code s. 664)</small>
BONE ONE	1260	600	600	5,41	17,57	WWBNN126060
BONE ONE	1510	500	600	5,82	18,39	WWBNN151050
BONE ONE	1510	600	800	6,51	21,05	WWBNN151060
CANE E	1300	390	600	6,8	19,01	WLCAN130039
CANE E	1600	390	800	7,7	21,53	WLCAN160039
CANE E	1900	390	800	8,6	24,71	WLCAN190039
CASE SLIM (METALL)	1360	420	400	5,26	33,38	WLCSS136042
CASE SLIM (METALL)	1360	520	600	6,23	40,72	WLCSS136052
CASE SLIM (METALL)	1360	620	600	7,19	48,03	WLCSS136062
CASE SLIM (METALL)	1585	420	400	6,18	38,93	WLCSS158042
CASE SLIM (METALL)	1585	520	600	7,31	47,48	WLCSS158052
CASE SLIM (METALL)	1585	620	800	8,45	56,03	WLCSS158062
CASE SLIM (METALL)	1810	420	600	7,09	44,47	WLCSS181042
CASE SLIM (METALL)	1810	520	600	8,40	54,24	WLCSS181052
CASE SLIM (METALL)	1810	620	800	9,70	64,02	WLCSS181062
CASE SLIM (GLAS)	1360	420	400	5,26	40,5	WLCSG136042
CASE SLIM (GLAS)	1360	520	600	6,23	49,5	WLCSG136052
CASE SLIM (GLAS)	1360	620	600	7,19	58,6	WLCSG136062
CASE SLIM (GLAS)	1585	420	400	6,18	47,3	WLCSG158042
CASE SLIM (GLAS)	1585	520	600	7,31	57,8	WLCSG158052
CASE SLIM (GLAS)	1585	620	800	8,45	68,4	WLCSG158062
CASE SLIM (GLAS)	1810	420	600	7,09	54,0	WLCSG181042
CASE SLIM (GLAS)	1810	520	600	8,40	66,1	WLCSG181052
CASE SLIM (GLAS)	1810	620	800	9,70	78,1	WLCSG181062
CASE SLIM (SPIEGEL)	1360	420	400	5,26	33,4	WLCSM136042
CASE SLIM (SPIEGEL)	1360	520	600	6,23	40,7	WLCSM136052
CASE SLIM (SPIEGEL)	1360	620	600	7,19	48,0	WLCSM136062
CASE SLIM (SPIEGEL)	1585	420	400	6,18	38,9	WLCSM158042
CASE SLIM (SPIEGEL)	1585	520	600	7,31	47,5	WLCSM158052
CASE SLIM (SPIEGEL)	1585	620	800	8,45	56,0	WLCSM158062
CASE SLIM (SPIEGEL)	1810	420	600	7,09	44,5	WLCSM181042
CASE SLIM (SPIEGEL)	1810	520	600	8,40	54,2	WLCSM181052
CASE SLIM (SPIEGEL)	1810	620	800	9,70	64,0	WLCSM181062
CASE SLIM (GRAFIK)	1360	420	400	5,26	41,5	WLCSP136042
CASE SLIM (GRAFIK)	1360	520	600	6,23	50,5	WLCSP136052
CASE SLIM (GRAFIK)	1360	620	600	7,19	59,6	WLCSP136062
CASE SLIM (GRAFIK)	1585	420	400	6,18	48,3	WLCSP158042
CASE SLIM (GRAFIK)	1585	520	600	7,31	58,8	WLCSP158052
CASE SLIM (GRAFIK)	1585	620	800	8,45	69,4	WLCSP158062
CASE SLIM (GRAFIK)	1810	420	600	7,09	55,0	WLCSP181042
CASE SLIM (GRAFIK)	1810	520	600	8,40	67,1	WLCSP181052
CASE SLIM (GRAFIK)	1810	620	800	9,70	79,1	WLCSP181062
CASE SLIM (BETON)	1360	420	400	5,26	36,47	WLCSB136042
CASE SLIM (BETON)	1360	520	600	6,23	44,27	WLCSB136052
CASE SLIM (BETON)	1360	620	600	7,19	52,11	WLCSB136062
CASE SLIM (BETON)	1585	420	400	6,18	42,43	WLCSB158042
CASE SLIM (BETON)	1585	520	600	7,31	51,50	WLCSB158052
CASE SLIM (BETON)	1585	620	800	8,45	60,57	WLCSB158062



Modell	A ↓	B ↔	 [W]	 [dm ²]	 [kg]	Artikelnummer <small>(Konfigurations code s. 664)</small>
CASE SLIM (BETON)	1810	420	600	7,09	48,30	WLCSB181042
CASE SLIM (BETON)	1810	520	600	8,40	58,67	WLCSB181052
CASE SLIM (BETON)	1810	620	800	9,70	69,03	WLCSB181062
CITY	510	500	300	1,82	8,06	WLCIT051050
CITY	510	600	400	2,03	9,21	WLCIT051060
CITY	780	500	400	2,81	12,40	WLCIT078050
CITY	780	600	600	3,13	14,17	WLCIT078060
CITY	1050	500	600	3,79	16,71	WLCIT105050
CITY	1050	600	800	4,23	19,12	WLCIT105060
CITY	1320	500	800	4,78	21,04	WLCIT132050
CITY	1320	600	800	5,32	24,07	WLCIT132060
CITY	1590	500	800	5,66	24,84	WLCIT159050
CITY	1590	600	1000	6,30	28,40	WLCIT159060
CITY	1860	500	1000	6,74	29,75	WLCIT186050
CITY	1860	600	1200	7,52	34,04	WLCIT186060
CITY ONE	780	500	400	2,74	12,34	WWCIN078050
CITY ONE	780	600	600	3,06	14,11	WWCIN078060
CITY ONE	1050	500	600	3,72	16,65	WWCIN105050
CITY ONE	1050	600	800	4,16	19,06	WWCIN105060
CITY ONE	1320	500	800	4,71	20,99	WWCIN132050
CITY ONE	1320	600	800	5,25	24,01	WWCIN132060
CITY ONE	1590	500	800	5,59	24,79	WWCIN159050
CITY ONE	1590	600	1000	6,23	28,35	WWCIN159060
CITY ONE	1860	500	1000	6,67	29,69	WWCIN186050
DELFIN	440	820	800	6,41	19,49	WLDLF044082
DELFIN	440	1020	800	8,01	24,31	WLDLF044102
DELFIN	440	1220	1000	9,60	29,12	WLDLF044122
DELFIN	540	820	800	7,61	23,13	WLDLF054082
DELFIN	540	1020	1000	9,50	28,86	WLDLF054102
DELFIN	540	1220	1200	11,39	34,58	WLDLF054122
DELFIN	640	820	1000	8,80	26,78	WLDLF064082
DELFIN	640	1020	1200	10,99	33,40	WLDLF064102
DELFIN	640	1220	1500	13,19	40,04	WLDLF064122
DEXTER	860	400	400	2,70	9,51	WLDEX086040
DEXTER	860	500	400	2,99	11,07	WLDEX086050
DEXTER	860	600	600	3,27	12,64	WLDEX086060
DEXTER	1220	400	400	3,82	13,33	WLDEX122040
DEXTER	1220	500	600	4,21	15,52	WLDEX122050
DEXTER	1220	600	800	4,61	17,70	WLDEX122060
DEXTER	1760	400	600	5,55	19,41	WLDEX176040
DEXTER	1760	500	800	6,14	22,64	WLDEX176050
DEXTER	1760	600	1000	6,72	25,86	WLDEX176060
DEXTER ONE	860	400	400	2,61	9,43	WWDEN086040
DEXTER ONE	860	500	400	2,90	11,00	WWDEN086050
DEXTER ONE	860	600	600	3,18	12,57	WWDEN086060
DEXTER ONE	1220	400	400	3,73	13,26	WWDEN122040
DEXTER ONE	1220	500	600	4,12	15,45	WWDEN122050
DEXTER ONE	1220	600	800	4,52	17,63	WWDEN122060



Modell	A ↑	B ↔	 [W]	 [dm ²]	 [kg]	Artikelnummer <small>(Konfigurations code s. 664)</small>
DEXTER ONE	1760	400	600	5,46	19,33	WWDEN176040
DEXTER ONE	1760	500	800	6,05	22,57	WWDEN176050
DEXTER ONE	1760	600	1000	6,63	25,79	WWDEN176060
DIAMOND	880	400	300	2,58	7,6	WLDIM088040
DIAMOND	880	500	300	2,97	8,8	WLDIM088050
DIAMOND	880	600	400	3,36	10,0	WLDIM088060
DIAMOND	1120	400	400	3,26	9,5	WLDIM112040
DIAMOND	1120	500	400	3,74	11,0	WLDIM112050
DIAMOND	1120	600	400	4,22	12,5	WLDIM112060
DIAMOND	1360	400	400	3,93	11,4	WLDIM136040
DIAMOND	1360	500	600	4,51	13,2	WLDIM136050
DIAMOND	1360	600	600	5,09	15,0	WLDIM136060
DIAMOND	1600	400	400	4,61	13,4	WLDIM160040
DIAMOND	1600	500	600	5,28	15,5	WLDIM160050
DIAMOND	1600	600	600	5,96	17,6	WLDIM160060
DOMI	786	400	300	2,13	6,50	WLDOM078040
DOMI	786	500	400	2,54	7,75	WLDOM078050
DOMI	786	600	400	2,86	8,93	WLDOM078060
DOMI	1116	400	400	3,27	9,74	WLDOM111040
DOMI	1116	500	600	3,76	11,54	WLDOM111050
DOMI	1116	600	600	4,25	13,33	WLDOM111060
DOMI	1479	400	600	4,31	12,77	WLDOM147040
DOMI	1479	500	600	4,95	15,13	WLDOM147050
DOMI	1479	600	800	5,59	17,48	WLDOM147060
EASY	640	200	120	1,76	4,34	WLEAS064020
EASY	960	200	200	2,64	6,39	WLEAS096020
EASY	1280	200	300	3,52	8,45	WLEAS128020
EASY	1600	200	300	4,40	10,50	WLEAS160020
EASY	1920	200	400	5,27	12,55	WLEAS192020
EASY DW	1660	200	300	4,40	10,50	WLEAW166020
EASY DW	1980	200	400	5,27	12,55	WLEAW198020
EASY ONE	960	200	200	2,53	6,45	WWEAN096020
EASY ONE	1280	200	300	3,41	8,54	WWEAN128020
EASY ONE	1600	200	300	4,29	10,64	WWEAN160020
EASY ONE	1920	200	400	5,16	12,73	WWEAN192020
FIONA	660	400	300	2,18	6,3	WLFIN066040
FIONA	660	430	300	2,29	6,6	WLFIN066043
FIONA	660	480	300	2,46	7,1	WLFIN066048
FIONA	660	500	300	2,54	7,3	WLFIN066050
FIONA	660	530	300	2,64	7,7	WLFIN066053
FIONA	660	580	300	2,82	8,2	WLFIN066058
FIONA	660	600	400	2,89	8,4	WLFIN066060
FIONA	660	630	400	3,00	8,8	WLFIN066063
FIONA	660	680	400	3,18	9,3	WLFIN066068
FIONA	900	400	300	2,93	8,4	WLFIN090040
FIONA	900	430	400	3,08	8,8	WLFIN090043
FIONA	900	480	400	3,32	9,5	WLFIN090048
FIONA	900	500	400	3,41	9,8	WLFIN090050



Modell	A ↓	B ↔	 [W]	 [dm³]	 [kg]	Artikelnummer <small>(Konfigurations code s. 664)</small>
FIONA	900	530	400	3,55	10,3	WLFIN090053
FIONA	900	580	400	3,79	11,0	WLFIN090058
FIONA	900	600	400	3,89	11,3	WLFIN090060
FIONA	900	630	400	4,03	11,7	WLFIN090063
FIONA	900	680	600	4,27	12,4	WLFIN090068
FIONA	1140	400	400	3,69	10,5	WLFIN114040
FIONA	1140	430	400	3,87	11,1	WLFIN114043
FIONA	1140	480	400	4,17	12,0	WLFIN114048
FIONA	1140	500	600	4,29	12,3	WLFIN114050
FIONA	1140	530	600	4,47	12,9	WLFIN114053
FIONA	1140	580	600	4,76	13,8	WLFIN114058
FIONA	1140	600	600	4,88	14,2	WLFIN114060
FIONA	1140	630	600	5,06	14,7	WLFIN114063
FIONA	1140	680	600	5,36	15,6	WLFIN114068
FIONA	1380	400	600	4,44	12,6	WLFIN138040
FIONA	1380	430	600	4,66	13,3	WLFIN138043
FIONA	1380	480	600	5,02	14,4	WLFIN138048
FIONA	1380	500	600	5,16	14,8	WLFIN138050
FIONA	1380	530	600	5,38	15,5	WLFIN138053
FIONA	1380	580	600	5,73	16,6	WLFIN138058
FIONA	1380	600	800	5,88	17,0	WLFIN138060
FIONA	1380	630	800	6,09	17,7	WLFIN138063
FIONA	1380	680	800	6,45	18,8	WLFIN138068
FIONA	1620	400	600	5,20	14,8	WLFIN162040
FIONA	1620	430	600	5,45	15,5	WLFIN162043
FIONA	1620	480	600	5,87	16,8	WLFIN162048
FIONA	1620	500	800	6,04	17,3	WLFIN162050
FIONA	1620	530	800	6,29	18,1	WLFIN162053
FIONA	1620	580	800	6,70	19,4	WLFIN162058
FIONA	1620	600	800	6,87	19,9	WLFIN162060
FIONA	1620	630	800	7,12	20,6	WLFIN162063
FIONA	1620	680	1000	7,54	21,9	WLFIN162068
FIONA	1860	400	600	5,95	16,9	WLFIN186040
FIONA	1860	430	800	6,24	17,8	WLFIN186043
FIONA	1860	480	800	6,72	19,2	WLFIN186048
FIONA	1860	500	800	6,91	19,8	WLFIN186050
FIONA	1860	530	800	7,20	20,7	WLFIN186053
FIONA	1860	580	1000	7,67	22,2	WLFIN186058
FIONA	1860	600	1000	7,87	22,7	WLFIN186060
FIONA	1860	630	1000	8,15	23,6	WLFIN186063
FIONA	1860	680	1000	8,63	25,1	WLFIN186068
FIONA ONE	900	400	400	2,87	8,3	WWFIE090040
FIONA ONE	900	430	400	3,01	8,8	WWFIE090043
FIONA ONE	900	480	400	3,25	9,5	WWFIE090048
FIONA ONE	900	500	400	3,35	9,8	WWFIE090050
FIONA ONE	900	530	400	3,49	10,2	WWFIE090053
FIONA ONE	900	580	400	3,73	10,9	WWFIE090058
FIONA ONE	900	600	400	3,82	11,2	WWFIE090060



Modell	A ↑	B ↔	 [W]	 [dm ²]	 [kg]	Artikelnummer <small>(Konfigurations code s. 664)</small>
FIONA ONE	900	630	400	3,97	11,7	WWFIE090063
FIONA ONE	900	680	400	4,21	12,4	WWFIE090068
FIONA ONE	1140	400	400	3,62	10,5	WWFIE114040
FIONA ONE	1140	430	400	3,80	11,0	WWFIE114043
FIONA ONE	1140	480	400	4,10	11,9	WWFIE114048
FIONA ONE	1140	500	400	4,22	12,3	WWFIE114050
FIONA ONE	1140	530	600	4,40	12,8	WWFIE114053
FIONA ONE	1140	580	600	4,70	13,7	WWFIE114058
FIONA ONE	1140	600	600	4,82	14,1	WWFIE114060
FIONA ONE	1140	630	600	5,00	14,6	WWFIE114063
FIONA ONE	1140	680	600	5,30	15,6	WWFIE114068
FIONA ONE	1380	400	600	4,38	12,6	WWFIE138040
FIONA ONE	1380	430	600	4,59	13,3	WWFIE138043
FIONA ONE	1380	480	600	4,95	14,3	WWFIE138048
FIONA ONE	1380	500	600	5,09	14,8	WWFIE138050
FIONA ONE	1380	530	600	5,31	15,4	WWFIE138053
FIONA ONE	1380	580	600	5,67	16,5	WWFIE138058
FIONA ONE	1380	600	600	5,81	17,0	WWFIE138060
FIONA ONE	1380	630	800	6,03	17,6	WWFIE138063
FIONA ONE	1380	680	800	6,38	18,7	WWFIE138068
FIONA ONE	1620	400	800	5,13	14,7	WWFIE162040
FIONA ONE	1620	430	600	5,38	15,5	WWFIE162043
FIONA ONE	1620	480	600	5,80	16,8	WWFIE162048
FIONA ONE	1620	500	600	5,97	17,3	WWFIE162050
FIONA ONE	1620	530	800	6,22	18,0	WWFIE162053
FIONA ONE	1620	580	800	6,64	19,3	WWFIE162058
FIONA ONE	1620	600	800	6,81	19,8	WWFIE162060
FIONA ONE	1620	630	800	7,06	20,6	WWFIE162063
FIONA ONE	1620	680	800	7,47	21,9	WWFIE162068
FIONA ONE	1860	400	800	5,89	16,9	WWFIE186040
FIONA ONE	1860	430	800	6,18	17,7	WWFIE186043
FIONA ONE	1860	480	800	6,65	19,2	WWFIE186048
FIONA ONE	1860	500	800	6,84	19,8	WWFIE186050
FIONA ONE	1860	530	800	7,13	20,7	WWFIE186053
FIONA ONE	1860	580	1000	7,61	22,1	WWFIE186058
FIONA ONE	1860	600	1000	7,80	22,7	WWFIE186060
FIONA ONE	1860	630	1000	8,09	23,6	WWFIE186063
FIONA ONE	1860	680	1000	8,56	25,0	WWFIE186068
INCORNER	465	350	300	1,53	6,61	WLQIN046035
INCORNER	735	350	400	2,34	10,06	WLQIN073035
INCORNER	1005	350	600	3,16	13,50	WLQIN100035
INCORNER	1275	350	800	3,98	16,95	WLQIN127035
INCORNER	1545	350	800	4,80	20,41	WLQIN154035
IRON D	730	400	400	3,29	15,9	WLIRD073040
IRON D	730	500	600	3,89	18,8	WLIRD073050
IRON D	730	600	600	4,48	21,8	WLIRD073060
IRON D	925	400	600	4,32	20,8	WLIRD092040
IRON D	925	500	800	5,11	24,7	WLIRD092050



Modell	A ↓	B ↔	 [W]	 [dm ³]	 [kg]	Artikelnummer <small>(Konfigurations code s. 664)</small>
IRON D	925	600	800	5,90	28,6	WLIRD092060
IRON D	1120	400	800	5,36	25,7	WLIRD112040
IRON D	1120	500	800	6,34	30,6	WLIRD112050
IRON D	1120	600	1000	7,33	35,4	WLIRD112060
IRON D	1315	400	800	6,39	30,6	WLIRD131040
IRON D	1315	500	1000	7,57	36,4	WLIRD131050
IRON D	1315	600	1200	8,76	42,3	WLIRD131060
IRON D	1510	400	1000	7,42	35,5	WLIRD151040
IRON D	1510	500	1000	8,80	42,3	WLIRD151050
IRON D	1510	600	1200	10,18	49,1	WLIRD151060
IRON D	1705	400	1000	8,45	40,4	WLIRD170040
IRON D	1705	500	1200	10,03	48,2	WLIRD170050
IRON D	1705	600	1500	11,61	56,0	WLIRD170060
KIOTO	555	480	300	1,97	8,69	WLKIO055048
KIOTO	870	480	400	3,01	13,14	WLKIO087048
KIOTO	1185	480	600	4,05	17,59	WLKIO118048
KIOTO	1500	480	800	5,09	22,04	WLKIO150048
KIOTO	1815	480	1000	6,13	26,50	WLKIO181048
KIOTO ONE	870	480	400	2,96	13,10	WWKIN087048
KIOTO ONE	1185	480	600	4,00	17,55	WWKIN118048
KIOTO ONE	1500	480	800	5,04	22,00	WWKIN150048
KIOTO ONE	1815	480	1000	6,08	26,45	WWKIN181048
LENA	660	400	300	2,23	6,4	WLLEN066040
LENA	660	436	300	2,36	6,8	WLLEN066043
LENA	660	486	300	2,54	7,3	WLLEN066048
LENA	660	500	300	2,59	7,5	WLLEN066050
LENA	660	536	300	2,72	7,9	WLLEN066053
LENA	660	586	400	2,90	8,4	WLLEN066058
LENA	660	600	400	2,95	8,6	WLLEN066060
LENA	660	636	400	3,08	9,0	WLLEN066063
LENA	660	686	400	3,26	9,5	WLLEN066068
LENA	900	400	300	3,01	8,6	WLLEN090040
LENA	900	436	400	3,18	9,1	WLLEN090043
LENA	900	486	400	3,42	9,8	WLLEN090048
LENA	900	500	400	3,48	10,1	WLLEN090050
LENA	900	536	400	3,65	10,6	WLLEN090053
LENA	900	586	400	3,89	11,3	WLLEN090058
LENA	900	600	400	3,96	11,5	WLLEN090060
LENA	900	636	600	4,13	12,0	WLLEN090063
LENA	900	686	600	4,37	12,8	WLLEN090068
LENA	1140	400	400	3,78	10,8	WLLEN114040
LENA	1140	436	400	3,99	11,4	WLLEN114043
LENA	1140	486	600	4,29	12,3	WLLEN114048
LENA	1140	500	600	4,38	12,6	WLLEN114050
LENA	1140	536	600	4,59	13,3	WLLEN114053
LENA	1140	586	600	4,89	14,2	WLLEN114058
LENA	1140	600	600	4,97	14,4	WLLEN114060
LENA	1140	636	600	5,19	15,1	WLLEN114063



Modell	A ↓	B ↔	 [W]	 [dm ²]	 [kg]	Artikelnummer <small>(Konfigurations code s. 664)</small>
LENA	1140	686	600	5,49	16,0	WLLLEN114068
LENA	1380	400	600	4,55	13,0	WLLLEN138040
LENA	1380	436	600	4,81	13,8	WLLLEN138043
LENA	1380	486	600	5,17	14,9	WLLLEN138048
LENA	1380	500	600	5,27	15,2	WLLLEN138050
LENA	1380	536	600	5,53	15,9	WLLLEN138053
LENA	1380	586	800	5,88	17,0	WLLLEN138058
LENA	1380	600	800	5,98	17,3	WLLLEN138060
LENA	1380	636	800	6,24	18,1	WLLLEN138063
LENA	1380	686	800	6,60	19,2	WLLLEN138068
LENA	1620	400	600	5,32	15,2	WLLLEN162040
LENA	1620	436	600	5,63	16,1	WLLLEN162043
LENA	1620	486	800	6,04	17,3	WLLLEN162048
LENA	1620	500	800	6,16	17,7	WLLLEN162050
LENA	1620	536	800	6,46	18,6	WLLLEN162053
LENA	1620	586	800	6,88	19,9	WLLLEN162058
LENA	1620	600	800	7,00	20,3	WLLLEN162060
LENA	1620	636	800	7,30	21,2	WLLLEN162063
LENA	1620	686	1000	7,72	22,5	WLLLEN162068
LENA	1860	400	600	6,10	17,4	WLLLEN186040
LENA	1860	436	800	6,44	18,4	WLLLEN186043
LENA	1860	486	800	6,92	19,9	WLLLEN186048
LENA	1860	500	800	7,05	20,3	WLLLEN186050
LENA	1860	536	800	7,40	21,3	WLLLEN186053
LENA	1860	586	1000	7,87	22,8	WLLLEN186058
LENA	1860	600	1000	8,01	23,2	WLLLEN186060
LENA	1860	636	1000	8,35	24,2	WLLLEN186063
LENA	1860	686	1000	8,83	25,7	WLLLEN186068
LIMA	500	300	120	1,50	4,3	WLLLIM050030
LIMA	500	400	200	1,79	5,2	WLLLIM050040
LIMA	500	500	200	2,09	6,1	WLLLIM050050
LIMA	500	600	300	2,39	7,0	WLLLIM050060
LIMA	500	700	300	2,69	7,9	WLLLIM050070
LIMA	500	1000	400	3,59	10,6	WLLLIM050100
LIMA	500	1200	600	4,18	12,5	WLLLIM050120
LIMA	820	300	300	2,53	7,2	WLLLIM082030
LIMA	820	400	300	3,07	8,8	WLLLIM082040
LIMA	820	500	400	3,61	10,5	WLLLIM082050
LIMA	820	600	400	4,15	12,1	WLLLIM082060
LIMA	820	700	600	4,68	13,7	WLLLIM082070
LIMA	1140	300	400	3,57	10,1	WLLLIM114030
LIMA	1140	400	400	4,35	12,5	WLLLIM114040
LIMA	1140	500	600	5,13	14,9	WLLLIM114050
LIMA	1140	600	800	5,90	17,2	WLLLIM114060
LIMA	1140	700	800	6,68	19,6	WLLLIM114070
LIMA	1460	300	400	4,66	13,2	WLLLIM146030
LIMA	1460	400	600	5,68	16,3	WLLLIM146040
LIMA	1460	500	800	6,69	19,4	WLLLIM146050



Modell	A ↓	B ↔	 [W]	 [dm³]	 [kg]	Artikelnummer <small>(Konfigurations code s. 664)</small>
LIMA	1460	600	800	7,71	22,5	WLLIM146060
LIMA	1460	700	1000	8,73	25,6	WLLIM146070
LIMA	1700	300	600	5,47	15,5	WLLIM170030
LIMA	1700	400	800	6,66	19,1	WLLIM170040
LIMA	1700	500	800	7,86	22,8	WLLIM170050
LIMA	1700	600	1000	9,05	26,4	WLLIM170060
LIMA	1700	700	1200	10,25	30,0	WLLIM170070
LIMA ONE	820	300	300	2,47	6,94	WWLIE082030
LIMA ONE	820	400	300	3,01	8,54	WWLIE082040
LIMA ONE	820	500	400	3,54	10,12	WWLIE082050
LIMA ONE	820	600	400	4,08	11,70	WWLIE082060
LIMA ONE	820	700	600	4,62	13,29	WWLIE082070
LIMA ONE	1140	300	400	3,51	9,78	WWLIE114030
LIMA ONE	1140	400	400	4,28	12,08	WWLIE114040
LIMA ONE	1140	500	600	5,06	14,37	WWLIE114050
LIMA ONE	1140	600	800	5,84	16,67	WWLIE114060
LIMA ONE	1140	700	800	6,61	18,96	WWLIE114070
LIMA ONE	1460	300	400	4,60	12,79	WWLIE146030
LIMA ONE	1460	400	600	5,61	15,78	WWLIE146040
LIMA ONE	1460	500	800	6,63	18,78	WWLIE146050
LIMA ONE	1460	600	800	7,64	21,78	WWLIE146060
LIMA ONE	1460	700	1000	8,66	24,78	WWLIE146070
LIMA ONE	1700	300	600	5,40	14,99	WWLIE170030
LIMA ONE	1700	400	800	6,60	18,53	WWLIE170040
LIMA ONE	1700	500	800	7,79	22,05	WWLIE170050
LIMA ONE	1700	600	1000	8,99	25,58	WWLIE170060
MANTIS	860	440	400	3,03	11,79	WLMAT086044
MANTIS	860	540	400	3,41	13,82	WLMAT086054
MANTIS	1260	440	600	4,44	17,46	WLMAT126044
MANTIS	1260	540	600	5,00	20,36	WLMAT126054
MANTIS	1560	440	600	5,47	21,47	WLMAT156044
MANTIS	1560	540	800	6,17	25,06	WLMAT156054
MANTIS ONE	860	440	400	2,94	11,72	WWMAE086044
MANTIS ONE	860	540	400	3,32	13,75	WWMAE086054
MANTIS ONE	1260	440	600	4,35	17,38	WWMAE126044
MANTIS ONE	1260	540	600	4,91	20,29	WWMAE126054
MANTIS ONE	1560	440	600	5,38	21,40	WWMAE156044
MANTIS ONE	1560	540	800	6,08	24,98	WWMAE156054
MARLIN	600	430	300	1,57	6,30	WLMAR060043
MARLIN	600	530	300	1,76	7,35	WLMAR060053
MARLIN	600	630	400	1,94	8,38	WLMAR060063
MARLIN	780	430	300	2,11	8,55	WLMAR078043
MARLIN	780	530	400	2,38	10,01	WLMAR078053
MARLIN	780	630	400	2,64	11,46	WLMAR078063
MARLIN	1185	430	400	3,25	13,15	WLMAR118043
MARLIN	1185	530	600	3,66	15,44	WLMAR118053
MARLIN	1185	630	800	4,08	17,73	WLMAR118063
MARLIN	1680	430	600	4,66	18,89	WLMAR168043



Modell	A ↑	B ↔	 [W]	 [dm ²]	 [kg]	Artikelnummer <small>(Konfigurations code s. 664)</small>
MARLIN	1680	530	800	5,27	22,24	WLMAR168053
MARLIN	1680	630	1000	5,87	25,56	WLMAR168063
MARLIN ONE	780	430	300	2,11	8,50	WWMRN078043
MARLIN ONE	780	530	400	2,38	9,96	WWMRN078053
MARLIN ONE	780	630	400	2,64	11,41	WWMRN078063
MARLIN ONE	1185	430	400	3,25	13,11	WWMRN118043
MARLIN ONE	1185	530	600	3,66	15,40	WWMRN118053
MARLIN ONE	1185	630	800	4,08	17,69	WWMRN118063
MARLIN ONE	1680	430	600	4,66	18,85	WWMRN168043
MARLIN ONE	1680	530	800	5,27	22,20	WWMRN168053
MARLIN ONE	1680	630	1000	5,87	25,52	WWMRN168063
MICHELLE	780	400	400	2,84	12,40	WLMIC078040
MICHELLE	780	500	400	3,29	14,05	WLMIC078050
MICHELLE	780	600	600	3,75	15,73	WLMIC078060
MICHELLE	1200	400	600	4,46	19,45	WLMIC120040
MICHELLE	1200	500	800	5,18	22,09	WLMIC120050
MICHELLE	1200	600	800	5,90	24,72	WLMIC120060
MICHELLE	1620	400	800	6,10	26,55	WLMIC162040
MICHELLE	1620	500	1000	7,08	30,15	WLMIC162050
MICHELLE	1620	600	1200	8,06	33,75	WLMIC162060
MIKE	710	230	200	1,40	4,51	WLMIK071023
MIKE	735	430	400	2,07	7,60	WLMIK073043
MIKE	735	530	400	2,34	8,89	WLMIK073053
MIKE	960	230	300	1,89	6,05	WLMIK096023
MIKE	1035	430	400	2,89	10,55	WLMIK103043
MIKE	1035	530	600	3,26	12,33	WLMIK103053
MIKE	1210	230	300	2,38	7,59	WLMIK121023
MIKE	1335	430	600	3,71	13,52	WLMIK133043
MIKE	1335	530	800	4,19	15,79	WLMIK133053
MIKE	1460	230	400	2,86	9,12	WLMIK146023
MIKE	1635	430	800	4,53	16,48	WLMIK163043
MIKE	1635	530	800	5,11	19,25	WLMIK163053
MIKE	1710	230	400	3,35	10,65	WLMIK171023
MIKE ONE	710	230	200	1,34	4,34	WWMIN071023
MIKE ONE	735	430	400	2,00	7,36	WWMIN073043
MIKE ONE	735	530	400	2,27	8,60	WWMIN073053
MIKE ONE	960	230	300	1,82	5,83	WWMIN096023
MIKE ONE	1035	430	400	2,82	10,23	WWMIN103043
MIKE ONE	1035	530	600	3,20	11,95	WWMIN103053
MIKE ONE	1210	230	300	2,31	7,32	WWMIN121023
MIKE ONE	1335	430	600	3,64	13,10	WWMIN133043
MIKE ONE	1335	530	800	4,12	15,30	WWMIN133053
MIKE ONE	1460	230	400	2,80	8,81	WWMIN146023
MIKE ONE	1635	430	800	4,46	15,97	WWMIN163043
MIKE ONE	1635	530	800	5,05	18,64	WWMIN163053
MIKE ONE	1710	230	400	3,29	10,30	WWMIN171023
NEMO	300	645	400	2,42	10,68	WLNEM030064
NEMO	300	915	600	3,45	15,21	WLNEM030091

Modell	A ↓	B ↔	 [W]	 [dm³]	 [kg]	Artikelnummer <small>(Konfigurations code s. 664)</small>
NEMO	300	1185	800	4,48	19,76	WLNEM030118
NEMO	300	1455	800	5,51	24,29	WLNEM030145
NEMO	300	1725	1000	6,54	28,85	WLNEM030172
NEMO	530	375	400	2,09	10,03	WLNEM053037
NEMO	530	645	600	3,64	17,45	WLNEM053064
NEMO	530	915	800	5,19	24,87	WLNEM053091
NEMO	530	1185	1200	6,74	32,31	WLNEM053118
NEMO	530	1455	1500	8,29	39,74	WLNEM053145
NEMO	530	1725	1500	9,84	47,19	WLNEM053172
OUTCORNER	465	300	300	1,56	6,77	WLQON046030
OUTCORNER	735	300	400	2,39	10,31	WLQON073030
OUTCORNER	1005	300	600	3,22	13,84	WLQON100030
OUTCORNER	1275	300	800	4,05	17,37	WLQON127030
OUTCORNER	1545	300	800	4,89	20,91	WLQON154030
PAJAK E	923	431	300	2,07	10,56	WLPAJ092043
PAJAK E	923	531	400	2,14	10,98	WLPAJ092053
PAJAK E	923	631	400	2,40	11,93	WLPAJ092063
PAJAK E	1323	431	400	2,64	12,10	WLPAJ132043
PAJAK E	1323	531	400	2,71	12,57	WLPAJ132053
PAJAK E	1323	631	600	2,96	13,48	WLPAJ132063
PAJAK E	1723	431	400	3,20	13,66	WLPAJ172043
PAJAK E	1723	531	600	3,26	14,12	WLPAJ172053
PAJAK E	1723	631	600	3,52	15,07	WLPAJ172063
PERLA E	1360	500	284	–	13,46	WSPER136050
PERLA E	1760	600	455	–	18,52	WSPER176060
Poc	600	450	300	3,19	9,06	WLZUL060045
Poc	600	500	400	3,45	9,84	WLZUL060050
Poc	600	600	400	3,99	11,42	WLZUL060060
Poc	840	450	400	4,29	12,23	WLZUL084045
Poc	840	500	600	4,64	13,29	WLZUL084050
Poc	840	600	600	5,36	15,41	WLZUL084060
Poc	840	700	800	6,07	17,52	WLZUL084070
Poc	1040	450	600	5,26	15,06	WLZUL104045
Poc	1040	500	600	5,70	16,35	WLZUL104050
Poc	1040	600	800	6,56	18,92	WLZUL104060
Poc	1040	700	800	7,42	21,49	WLZUL104070
Poc	1240	450	800	6,19	17,73	WLZUL124045
Poc	1240	500	800	6,70	19,25	WLZUL124050
Poc	1240	600	1000	7,71	22,28	WLZUL124060
Poc	1240	700	1000	8,72	25,29	WLZUL124070
Poc	1400	500	800	7,53	21,67	WLZUL140050
Poc	1400	600	1000	8,66	25,06	WLZUL140060
Poc	1400	700	1200	9,79	28,45	WLZUL140070
POLA	780	500	400	3,34	9,70	WLPAL078050
POLA	780	600	400	3,79	11,06	WLPAL078060
POLA	1180	500	600	5,39	15,65	WLPAL118050
POLA	1180	600	800	6,14	17,92	WLPAL118060
POLA	1580	500	800	7,44	21,60	WLPAL158050

Modell	A ↑	B ↔	 [W]	 [dm ²]	 [kg]	Artikelnummer <small>(Konfigurations code s. 664)</small>
POLA	1580	600	1000	8,49	24,79	WLPAL158060
POLA ONE	780	500	400	3,27	9,64	WWPAN078050
POLA ONE	780	600	400	3,72	11,00	WWPAN078060
POLA ONE	1180	500	600	5,33	15,60	WWPAN118050
POLA ONE	1180	600	800	6,07	17,87	WWPAN118060
POLA ONE	1580	500	800	7,38	21,55	WWPAN158050
POLA ONE	1580	600	1000	8,42	24,73	WWPAN158060
QUADRUS BOLD	870	450	600	4,11	19,03	WLQBA087045
QUADRUS BOLD	870	600	800	5,08	24,35	WLQBA087060
QUADRUS BOLD	1185	450	800	5,57	25,74	WLQBA118045
QUADRUS BOLD	1185	600	1000	6,88	32,95	WLQBA118060
QUADRUS BOLD ONE	870	450	600	4,05	18,98	WWQBN087045
QUADRUS BOLD ONE	870	600	800	5,01	24,30	WWQBN087060
QUADRUS BOLD ONE	1185	450	800	5,50	25,69	WWQBN118045
QUADRUS BOLD ONE	1185	600	1000	6,81	32,90	WWQBN118060
QUADRUS SLIM	870	450	400	2,60	10,92	WLQUS087045
QUADRUS SLIM	870	600	600	3,03	13,26	WLQUS087060
QUADRUS SLIM	1185	450	600	3,50	14,60	WLQUS118045
QUADRUS SLIM	1185	600	800	4,07	17,73	WLQUS118060
QUADRUS SLIM ONE	870	450	400	2,53	10,86	WWQSN087045
QUADRUS SLIM ONE	870	600	600	2,96	13,21	WWQSN087060
QUADRUS SLIM ONE	1185	450	600	3,43	14,54	WWQSN118045
QUADRUS SLIM ONE	1185	600	800	4,00	17,67	WWQSN118060
RETRO	430	504	120	1,05	5,42	WLRE1043050
RETRO	800	504	200	1,88	9,01	WLRE1080050
RETRO	1170	504	300	2,71	12,60	WLRE1117050
RETRO	1540	504	400	3,54	16,19	WLRE1154050
RIBBON V E	1800	290	600	3,33	28,52	WLRVE180029
RIBBON V E	1800	390	800	4,45	38,03	WLRVE180039
RIBBON V E	1800	490	1000	5,57	47,55	WLRVE180049
SIMPLE	480	500	200	1,96	5,43	WLSIM048050
SIMPLE	600	500	200	2,45	6,72	WLSIM060050
SIMPLE	720	500	300	2,94	8,02	WLSIM072050
SIMPLE	840	500	300	3,43	9,32	WLSIM084050
SIMPLE	960	500	400	3,92	10,61	WLSIM096050
SIMPLE	1080	500	400	4,41	11,90	WLSIM108050
SIMPLE	1200	500	400	4,90	13,20	WLSIM120050
SIMPLE	1440	500	600	5,89	15,80	WLSIM144050
SIMPLE	1680	500	600	6,87	18,39	WLSIM168050
SIMPLE	1920	500	800	7,85	20,99	WLSIM192050
SIMPLE DW	1515	500	600	5,89	15,80	WLSDW151050
SIMPLE DW	1755	500	600	6,87	18,39	WLSDW175050
SIMPLE DW	1995	500	800	7,85	20,99	WLSDW199050
SIMPLE ONE	720	500	300	2,87	7,96	WWSIE072050
SIMPLE ONE	840	500	300	3,36	9,26	WWSIE084050
SIMPLE ONE	960	500	400	3,85	10,55	WWSIE096050
SIMPLE ONE	1080	500	400	4,34	11,85	WWSIE108050
SIMPLE ONE	1200	500	400	4,83	13,14	WWSIE120050



Modell	A ↓	B ↔	 [W]	 [dm ³]	 [kg]	Artikelnummer <small>(Konfigurations code s. 664)</small>
SIMPLE ONE	1440	500	600	5,81	15,74	WWSIE144050
SIMPLE ONE	1680	500	600	6,79	18,33	WWSIE168050
SIMPLE ONE	1920	500	800	7,78	20,93	WWSIE192050
SHERWOOD V E	1000	330	600	5,53	18,10	WLSTV100033
SHERWOOD V E	1300	330	600	7,05	23,06	WLSTV130033
SHERWOOD V E	1300	440	800	9,80	29,81	WLSTV130044
SHERWOOD V E	1600	330	800	8,58	28,04	WLSTV160033
SHERWOOD V E	1600	440	1000	11,92	36,22	WLSTV160044
SHERWOOD V E	1600	540	1200	13,45	43,99	WLSTV160054
SHERWOOD V E	1900	330	800	10,10	33,01	WLSTV190033
SHERWOOD V E	1900	440	1200	14,05	42,62	WLSTV190044
SHERWOOD V E	1900	540	1500	15,84	51,79	WLSTV190054
TRIGA E	560	480	400	5,72	14,77	WLTRG056048
TRIGA E	560	680	600	8,01	20,74	WLTRG056068
TRIGA E	560	880	600	10,31	26,71	WLTRG056088
TRIGA E	560	1080	800	12,60	32,68	WLTRG056108
TRIGA E	560	1280	1000	14,90	38,65	WLTRG056128
TRIGA E	610	480	400	6,22	15,97	WLTRG061048
TRIGA E	610	680	600	8,71	22,42	WLTRG061068
TRIGA E	610	880	800	11,21	28,87	WLTRG061088
TRIGA E	610	1080	800	13,70	35,32	WLTRG061108
TRIGA E	610	1280	1000	16,19	41,76	WLTRG061128
TRIGA E	900	380	400	7,29	18,30	WLTRG090038
TRIGA E	900	480	600	9,11	22,92	WLTRG090048
TRIGA E	900	580	800	10,94	27,53	WLTRG090058
TRIGA E	900	680	800	12,76	32,15	WLTRG090068
TRIGA E	1300	380	600	10,48	25,97	WLTRG130038
TRIGA E	1300	480	800	13,10	32,50	WLTRG130048
TRIGA E	1300	580	1000	15,72	39,03	WLTRG130058
TRIGA E	1300	680	1200	18,34	45,56	WLTRG130068
TRIGA E	1700	380	800	13,67	33,64	WLTRG170038
TRIGA E	1700	480	1000	17,09	42,08	WLTRG170048
TRIGA E	1700	580	1200	20,51	50,53	WLTRG170058
TRIGA E	1700	680	1500	23,93	58,98	WLTRG170068
TRIGA E	1900	380	1000	15,26	37,47	WLTRG190038
TRIGA E	1900	480	1200	19,08	46,87	WLTRG190048
TRIGA E	1900	580	1500	22,90	56,28	WLTRG190058
TRIGA E	1900	680	1500	26,72	65,68	WLTRG190068
TRIGA M E	1700	680	600	10,55	37,76	WLTRL170068
TRIGA M E	1700	780	800	13,97	46,21	WLTRL170078
TRIGA M E	1700	880	1000	17,39	54,65	WLTRL170088
TRIGA M E	1900	680	800	11,75	42,01	WLTRL190068
TRIGA M E	1900	780	1000	15,57	51,42	WLTRL190078
TRIGA M E	1900	880	1200	19,39	60,83	WLTRL190088
TRIGA AN E	1700	280	1000	11,64	32,04	WLVER170028
TRIGA AN E	1900	280	1000	12,95	35,52	WLVER190028
TRIGA ANC E	1700	280	1000	11,64	32,04	WLVEC170028
TRIGA ANC E	1900	280	1000	12,95	35,52	WLVEC190028



Modell	A ↑	B ↔	 [W]	 [dm ²]	 [kg]	Artikelnummer <small>(Konfigurations code s. 664)</small>
TUNE VWD E	600	590	800	10,72	24,39	WLTUV060059
TUNE VWD E	600	790	1000	14,30	32,50	WLTUV060079
TUNE VWD E	600	990	1200	17,87	40,60	WLTUV060099
TUNE VWD E	600	1190	1500	21,45	48,71	WLTUV060119
TUNE VWD E	600	1390	1500	25,03	56,82	WLTUV060139
TUNE VWD E	1800	290	1000	15,26	34,07	WLTUV180029
TUNE VWD E	1800	490	1500	25,44	56,67	WLTUV180049
TUNE VWS E	600	590	400	5,77	13,24	WLTSV060059
TUNE VWS E	600	790	600	7,69	17,60	WLTSV060079
TUNE VWS E	600	990	800	9,62	21,95	WLTSV060099
TUNE VWS E	600	1190	1000	11,54	26,31	WLTSV060119
TUNE VWS E	600	1390	1000	13,47	30,66	WLTSV060139
TUNE VWS E	600	1590	1200	15,26	34,62	WLTSV060159
TUNE VWS E	1800	290	600	7,83	17,57	WLTSV180029
TUNE VWS E	1800	490	1000	13,06	29,18	WLTSV180049
TUNE VWS E	1800	690	1500	18,29	40,77	WLTSV180069
TYTUS	820	440	600	5,44	16,56	WLTYT082044
TYTUS	820	540	600	6,39	19,47	WLTYT082054
TYTUS	820	640	800	7,35	22,38	WLTYT082064
TYTUS	1020	440	600	7,03	21,36	WLTYT102044
TYTUS	1020	540	800	8,29	25,18	WLTYT102054
TYTUS	1020	640	1000	9,54	29,01	WLTYT102064
TYTUS	1260	440	800	8,46	25,67	WLTYT126044
TYTUS	1260	540	1000	9,95	30,22	WLTYT126054
TYTUS	1260	640	1200	11,44	34,77	WLTYT126064
TYTUS	1420	440	1000	9,73	29,51	WLTYT142044
TYTUS	1420	540	1200	11,46	34,79	WLTYT142054
TYTUS	1420	640	1200	13,20	40,07	WLTYT142064
TYTUS	1780	440	1200	12,11	36,70	WLTYT178044
TYTUS	1780	540	1500	14,26	43,25	WLTYT178054
TYTUS	1780	640	1500	16,41	49,80	WLTYT178064
TYTUS ONE	820	440	600	5,35	16,48	WWTYN082044
TYTUS ONE	820	540	600	6,31	19,40	WWTYN082054
TYTUS ONE	820	640	800	7,27	22,32	WWTYN082064
TYTUS ONE	1020	440	600	6,95	21,30	WWTYN102044
TYTUS ONE	1020	540	800	8,20	25,11	WWTYN102054
TYTUS ONE	1020	640	1000	9,46	28,94	WWTYN102064
TYTUS ONE	1260	440	800	8,37	25,60	WWTYN126044
TYTUS ONE	1260	540	1000	9,87	30,15	WWTYN126054
TYTUS ONE	1420	440	1000	9,65	29,45	WWTYN142044
WARP S	655	500	400	3,45	15,18	WLWAS065050
WARP S	655	600	600	3,98	17,78	WLWAS065060
WARP S	850	500	600	4,36	19,01	WLWAS111050
WARP S	850	600	600	5,02	22,26	WLWAS111060
WARP S	1110	500	800	5,99	26,15	WLWAS169050
WARP S	1110	600	800	6,91	30,70	WLWAS169060
WARP S	1695	500	1200	9,34	40,68	WLWAS169050
WARP S	1695	600	1200	10,79	47,81	WLWAS169060



Modell	A ↓	B ↔	 [W]	 [dm³]	 [kg]	Artikelnummer <small>(Konfigurations code s. 664)</small>
WARP T	655	500	300	2,32	14,21	WLWAT065050
WARP T	655	600	400	2,59	16,55	WLWAT065060
WARP T	1110	500	600	4,02	24,45	WLWAT111050
WARP T	1110	600	600	4,48	28,55	WLWAT111060
WARP T	1695	500	800	6,24	37,99	WLWAT169050
WARP T	1695	600	1000	6,96	44,44	WLWAT169060
WARP T ONE	655	500	300	2,23	14,13	WWWWTN065050
WARP T ONE	655	600	400	2,50	16,47	WWWWTN065060
WARP T ONE	1110	500	600	3,93	24,37	WWWWTN111050
WARP T ONE	1110	600	600	4,39	28,48	WWWWTN111060
WARP T ONE	1695	500	800	6,15	37,92	WWWWTN169050
WARP T ONE	1695	600	1000	6,87	44,36	WWWWTN169060
WARP T BOLD	1110	500	800	6,04	26,19	WLWTB111050
WARP T BOLD	1110	600	1000	6,96	30,74	WLWTB111060
WARP T BOLD	1695	500	1200	9,42	40,75	WLWTB169050
WARP T BOLD	1695	600	1500	10,86	47,89	WLWTB169060
WARP T BOLD ONE	655	500	400	3,48	15,22	WWWWBN065050
WARP T BOLD ONE	655	600	600	4,00	17,80	WWWWBN065060
WARP T BOLD ONE	1110	500	800	6,04	26,19	WWWWBN111050
WARP T BOLD ONE	1110	600	1000	6,96	30,74	WWWWBN111060
ZIGZAG	600	500	300	2,77	7,31	WLZIG060050
ZIGZAG	835	500	300	3,74	9,89	WLZIG083050
ZIGZAG	1070	500	400	4,72	12,46	WLZIG107050
ZIGZAG	1310	500	600	5,70	15,06	WLZIG131050
ZIGZAG	1545	500	600	6,67	17,63	WLZIG154050
ZIGZAG	1780	500	600	7,65	20,21	WLZIG178050



Elektro-Heizköper



Galvanische Oberfläche



Modell	A ↓	B ↔	 [W]	 [dm ²]	 [kg]	Artikelnummer <small>(Konfigurations code s. 664)</small>
ALEX	540	300	120	1,75	5,0	WLALE054030
ALEX	540	400	200	2,04	5,9	WLALE054040
ALEX	540	500	200	2,32	6,7	WLALE054050
ALEX	540	600	300	2,60	7,6	WLALE054060
ALEX	760	300	200	2,46	6,9	WLALE076030
ALEX	760	400	200	2,85	8,2	WLALE076040
ALEX	760	500	300	3,25	9,4	WLALE076050
ALEX	760	600	400	3,65	10,6	WLALE076060
ALEX	1140	300	300	3,78	10,6	WLALE114030
ALEX	1140	400	400	4,41	12,5	WLALE114040
ALEX	1140	500	400	5,03	14,5	WLALE114050
ALEX	1140	600	600	5,65	16,4	WLALE114060
ALEX	1580	500	600	6,90	19,8	WLALE158050
ALEX	1580	600	600	7,75	22,4	WLALE158060
ALEX	1580	700	800	8,60	25,0	WLALE158070
ALEX ONE	760	300	200	2,39	6,9	WWALN076030
ALEX ONE	760	400	200	2,79	8,1	WWALN076040
ALEX ONE	760	500	300	3,19	9,3	WWALN076050
ALEX ONE	760	600	400	3,58	10,5	WWALN076060
ALEX ONE	1140	300	300	3,72	10,6	WWALN114030
ALEX ONE	1140	400	400	4,34	12,5	WWALN114040
ALEX ONE	1140	500	400	4,97	14,4	WWALN114050
ALEX ONE	1140	600	600	5,59	16,3	WWALN114060
ALEX ONE	1580	500	600	6,83	19,7	WWALN158050
ALEX ONE	1580	600	600	7,68	22,3	WWALN158060
ALEX ONE	1580	700	800	8,53	24,9	WWALN158070
BONE	760	500	200	3,09	9,59	WLBON076050
BONE	760	600	300	3,46	10,99	WLBON076060
BONE	1260	500	400	4,93	15,05	WLBON126050
BONE	1260	600	400	5,51	17,21	WLBON126060
BONE	1510	500	400	5,92	18,02	WLBON151050
BONE	1510	600	600	6,61	20,59	WLBON151060
BONE ONE	760	500	200	2,99	9,51	WWBNN076050
BONE ONE	760	600	300	3,37	10,92	WWBNN076060
BONE ONE	1260	500	400	4,84	14,98	WWBNN126050
BONE ONE	1260	600	400	5,41	17,13	WWBNN126060
BONE ONE	1510	500	400	5,82	17,93	WWBNN151050
BONE ONE	1510	600	600	6,51	20,51	WWBNN151060
DEXTER	860	400	200	2,70	9,26	WLDEX086040
DEXTER	860	500	300	2,99	10,77	WLDEX086050
DEXTER	860	600	400	3,27	12,29	WLDEX086060
DEXTER	1220	400	300	3,82	12,98	WLDEX122040
DEXTER	1220	500	400	4,21	15,10	WLDEX122050
DEXTER	1220	600	400	4,61	17,22	WLDEX122060
DEXTER	1760	400	400	5,55	18,90	WLDEX176040
DEXTER	1760	500	600	6,14	22,02	WLDEX176050
DEXTER	1760	600	600	6,72	25,15	WLDEX176060
DEXTER ONE	860	400	200	2,61	9,18	WWDEN086040



Modell	A ↓	B ↔	 [W]	 [dm ²]	 [kg]	Artikelnummer <small>(Konfigurations code s. 664)</small>
DEXTER ONE	860	500	300	2,90	10,70	WWDEN086050
DEXTER ONE	860	600	400	3,18	12,22	WWDEN086060
DEXTER ONE	1220	400	300	3,73	12,91	WWDEN122040
DEXTER ONE	1220	500	400	4,12	15,03	WWDEN122050
DEXTER ONE	1220	600	400	4,52	17,15	WWDEN122060
DEXTER ONE	1760	400	400	5,46	18,82	WWDEN176040
DEXTER ONE	1760	500	600	6,05	21,95	WWDEN176050
DEXTER ONE	1760	600	600	6,63	25,08	WWDEN176060
DIAMOND	880	400	200	2,58	7,42	WLDIM088040
DIAMOND	880	500	200	2,97	8,60	WLDIM088050
DIAMOND	880	600	300	3,36	9,77	WLDIM088060
DIAMOND	1120	400	200	3,26	9,29	WLDIM112040
DIAMOND	1120	500	300	3,74	10,76	WLDIM112050
DIAMOND	1120	600	300	4,22	12,22	WLDIM112060
DIAMOND	1360	400	300	3,93	11,16	WLDIM136040
DIAMOND	1360	500	400	4,51	12,92	WLDIM136050
DIAMOND	1360	600	400	5,09	14,67	WLDIM136060
DIAMOND	1600	400	400	4,61	13,03	WLDIM160040
DIAMOND	1600	500	400	5,28	15,09	WLDIM160050
DIAMOND	1600	600	400	5,96	17,14	WLDIM160060
DOMI	786	400	200	2,13	6,30	WLDOM078040
DOMI	786	500	300	2,54	7,51	WLDOM078050
DOMI	786	600	300	2,86	8,65	WLDOM078060
DOMI	1116	400	300	3,27	9,45	WLDOM111040
DOMI	1116	500	400	3,76	11,19	WLDOM111050
DOMI	1116	600	400	4,25	12,93	WLDOM111060
DOMI	1479	400	400	4,31	12,39	WLDOM147040
DOMI	1479	500	400	4,95	14,67	WLDOM147050
DOMI	1479	600	600	5,59	16,95	WLDOM147060
EASY	640	200	120	1,76	4,35	WLEAS064020
EASY	960	200	120	2,64	6,40	WLEAS096020
EASY	1280	200	200	3,52	8,45	WLEAS128020
EASY	1600	200	200	4,40	10,50	WLEAS160020
EASY ONE	960	200	120	2,53	6,31	WWEAN096020
EASY ONE	1280	200	200	3,41	8,36	WWEAN128020
EASY ONE	1600	200	200	4,29	10,41	WWEAN160020
FIONA	660	400	120	2,18	6,3	WLFIN066040
FIONA	660	430	200	2,29	6,4	WLFIN066043
FIONA	660	480	200	2,46	6,9	WLFIN066048
FIONA	660	500	200	2,54	7,1	WLFIN066050
FIONA	660	530	200	2,64	7,4	WLFIN066053
FIONA	660	580	200	2,82	8,0	WLFIN066058
FIONA	660	600	200	2,89	8,2	WLFIN066060
FIONA	660	630	300	3,00	8,5	WLFIN066063
FIONA	660	680	300	3,18	9,1	WLFIN066068
FIONA	900	400	200	2,93	8,1	WLFIN090040
FIONA	900	430	300	3,08	8,6	WLFIN090043
FIONA	900	480	300	3,32	9,3	WLFIN090048

Modell	A ↓	B ↔	 [W]	 [dm²]	 [kg]	Artikelnummer <small>(Konfigurations code s. 664)</small>
FIONA	900	500	300	3,41	9,6	WLFIN090050
FIONA	900	530	300	3,55	10,0	WLFIN090053
FIONA	900	580	300	3,79	10,7	WLFIN090058
FIONA	900	600	300	3,89	11,0	WLFIN090060
FIONA	900	630	300	4,03	11,4	WLFIN090063
FIONA	900	680	400	4,27	12,1	WLFIN090068
FIONA	1140	400	300	3,69	10,2	WLFIN114040
FIONA	1140	430	300	3,87	10,8	WLFIN114043
FIONA	1140	480	300	4,17	11,6	WLFIN114048
FIONA	1140	500	400	4,29	12,0	WLFIN114050
FIONA	1140	530	400	4,47	12,5	WLFIN114053
FIONA	1140	580	400	4,76	13,4	WLFIN114058
FIONA	1140	600	400	4,88	13,8	WLFIN114060
FIONA	1140	630	400	5,06	14,3	WLFIN114063
FIONA	1140	680	400	5,36	15,1	WLFIN114068
FIONA	1380	400	400	4,44	12,3	WLFIN138040
FIONA	1380	430	400	4,66	12,9	WLFIN138043
FIONA	1380	480	400	5,02	14,0	WLFIN138048
FIONA	1380	500	400	5,16	14,4	WLFIN138050
FIONA	1380	530	400	5,38	15,1	WLFIN138053
FIONA	1380	580	400	5,73	16,1	WLFIN138058
FIONA	1380	600	400	5,88	16,5	WLFIN138060
FIONA	1380	630	600	6,09	17,2	WLFIN138063
FIONA	1380	680	600	6,45	18,2	WLFIN138068
FIONA	1620	400	400	5,20	14,4	WLFIN162040
FIONA	1620	430	400	5,45	15,1	WLFIN162043
FIONA	1620	480	400	5,87	16,4	WLFIN162048
FIONA	1620	500	600	6,04	16,9	WLFIN162050
FIONA	1620	530	600	6,29	17,6	WLFIN162053
FIONA	1620	580	600	6,70	18,8	WLFIN162058
FIONA	1620	600	600	6,87	19,3	WLFIN162060
FIONA	1620	630	600	7,12	20,1	WLFIN162063
FIONA	1620	680	600	7,54	21,3	WLFIN162068
FIONA ONE	900	400	200	2,87	8,1	WWFIE090040
FIONA ONE	900	430	300	3,01	8,5	WWFIE090043
FIONA ONE	900	480	300	3,25	9,2	WWFIE090048
FIONA ONE	900	500	300	3,35	9,5	WWFIE090050
FIONA ONE	900	530	300	3,49	9,9	WWFIE090053
FIONA ONE	900	580	300	3,73	10,6	WWFIE090058
FIONA ONE	900	600	300	3,82	10,9	WWFIE090060
FIONA ONE	900	630	300	3,97	11,4	WWFIE090063
FIONA ONE	900	680	300	4,21	12,1	WWFIE090068
FIONA ONE	1140	400	300	3,62	10,2	WWFIE114040
FIONA ONE	1140	430	300	3,80	10,7	WWFIE114043
FIONA ONE	1140	480	300	4,10	11,6	WWFIE114048
FIONA ONE	1140	500	400	4,22	11,9	WWFIE114050
FIONA ONE	1140	530	400	4,40	12,5	WWFIE114053
FIONA ONE	1140	580	400	4,70	13,4	WWFIE114058

Modell	A ↓	B ↔	 [W]	 [dm³]	 [kg]	Artikelnummer <small>(Konfigurations code s. 664)</small>
FIONA ONE	1140	600	400	4,82	13,7	WWFIE114060
FIONA ONE	1140	630	400	5,00	14,2	WWFIE114063
FIONA ONE	1140	680	400	5,30	15,1	WWFIE114068
FIONA ONE	1380	400	400	4,38	12,3	WWFIE138040
FIONA ONE	1380	430	400	4,59	12,9	WWFIE138043
FIONA ONE	1380	480	400	4,95	13,9	WWFIE138048
FIONA ONE	1380	500	400	5,09	14,4	WWFIE138050
FIONA ONE	1380	530	400	5,31	15,0	WWFIE138053
FIONA ONE	1380	580	400	5,67	16,1	WWFIE138058
FIONA ONE	1380	600	400	5,81	16,5	WWFIE138060
FIONA ONE	1380	630	600	6,03	17,1	WWFIE138063
FIONA ONE	1380	680	600	6,38	18,2	WWFIE138068
FIONA ONE	1620	400	400	5,13	14,3	WWFIE162040
FIONA ONE	1620	430	400	5,38	15,1	WWFIE162043
FIONA ONE	1620	480	400	5,80	16,3	WWFIE162048
FIONA ONE	1620	500	600	5,97	16,8	WWFIE162050
FIONA ONE	1620	530	600	6,22	17,5	WWFIE162053
FIONA ONE	1620	580	600	6,64	18,8	WWFIE162058
FIONA ONE	1620	600	600	6,81	19,3	WWFIE162060
FIONA ONE	1620	630	600	7,06	20,0	WWFIE162063
FIONA ONE	1620	680	600	7,47	21,2	WWFIE162068
LENA	660	400	200	2,23	6,23	WLLen066040
LENA	660	436	200	2,36	6,61	WLLen066043
LENA	660	486	200	2,54	7,14	WLLen066048
LENA	660	500	200	2,59	7,29	WLLen066050
LENA	660	536	200	2,72	7,67	WLLen066053
LENA	660	586	200	2,90	8,20	WLLen066058
LENA	660	600	200	2,95	8,35	WLLen066060
LENA	660	636	300	3,08	8,72	WLLen066063
LENA	660	686	300	3,26	9,26	WLLen066068
LENA	900	400	200	3,01	8,36	WLLen090040
LENA	900	436	300	3,18	8,87	WLLen090043
LENA	900	486	300	3,42	9,57	WLLen090048
LENA	900	500	300	3,48	9,77	WLLen090050
LENA	900	536	300	3,65	10,28	WLLen090053
LENA	900	586	300	3,89	10,98	WLLen090058
LENA	900	600	300	3,96	11,18	WLLen090060
LENA	900	636	400	4,13	11,69	WLLen090063
LENA	900	686	400	4,37	12,39	WLLen090068
LENA	1140	400	300	3,78	10,49	WLLen114040
LENA	1140	436	300	3,99	11,12	WLLen114043
LENA	1140	486	400	4,29	12,00	WLLen114048
LENA	1140	500	400	4,38	12,26	WLLen114050
LENA	1140	536	400	4,59	12,89	WLLen114053
LENA	1140	586	400	4,89	13,77	WLLen114058
LENA	1140	600	400	4,97	14,02	WLLen114060
LENA	1140	636	400	5,19	14,65	WLLen114063
LENA	1140	686	400	5,49	15,54	WLLen114068

Modell	A ↓	B ↔	 [W]	 [dm ³]	 [kg]	Artikelnummer <small>(Konfigurations code s. 664)</small>
LENA	1380	400	400	4,55	12,62	WLLLEN138040
LENA	1380	436	400	4,81	13,38	WLLLEN138043
LENA	1380	486	400	5,17	14,44	WLLLEN138048
LENA	1380	500	400	5,27	14,74	WLLLEN138050
LENA	1380	536	400	5,53	15,50	WLLLEN138053
LENA	1380	586	400	5,88	16,55	WLLLEN138058
LENA	1380	600	600	5,98	16,84	WLLLEN138060
LENA	1380	636	600	6,24	17,61	WLLLEN138063
LENA	1380	686	600	6,60	18,68	WLLLEN138068
LENA	1620	400	400	5,32	14,74	WLLLEN162040
LENA	1620	436	400	5,63	15,64	WLLLEN162043
LENA	1620	486	400	6,04	16,86	WLLLEN162048
LENA	1620	500	600	6,16	17,22	WLLLEN162050
LENA	1620	536	600	6,46	18,10	WLLLEN162053
LENA	1620	586	600	6,88	19,34	WLLLEN162058
LENA	1620	600	600	7,00	19,69	WLLLEN162060
LENA	1620	636	600	7,30	20,57	WLLLEN162063
LENA	1620	686	600	7,72	21,81	WLLLEN162068
LIMA	500	300	120	1,50	4,15	WLLIM050030
LIMA	500	400	120	1,79	5,04	WLLIM050040
LIMA	500	500	200	2,09	5,92	WLLIM050050
LIMA	500	600	200	2,39	6,80	WLLIM050060
LIMA	500	700	200	2,69	7,68	WLLIM050070
LIMA	500	1000	400	3,59	10,33	WLLIM050100
LIMA	500	1200	400	4,18	12,10	WLLIM050120
LIMA	500	1400	400	4,78	13,86	WLLIM050140
LIMA	820	300	200	2,53	7,00	WLLIM082030
LIMA	820	400	200	3,07	8,58	WLLIM082040
LIMA	820	500	300	3,61	10,17	WLLIM082050
LIMA	820	600	400	4,15	11,76	WLLIM082060
LIMA	820	700	400	4,68	13,35	WLLIM082070
LIMA	1140	300	300	3,57	9,84	WLLIM114030
LIMA	1140	400	300	4,35	12,13	WLLIM114040
LIMA	1140	500	400	5,13	14,43	WLLIM114050
LIMA	1140	600	400	5,90	16,72	WLLIM114060
LIMA	1140	700	600	6,68	19,02	WLLIM114070
LIMA	1460	300	300	4,66	12,84	WLLIM146030
LIMA	1460	400	400	5,68	15,84	WLLIM146040
LIMA	1460	500	600	6,69	18,84	WLLIM146050
LIMA	1460	600	600	7,71	21,84	WLLIM146060
LIMA	1460	700	800	8,73	24,84	WLLIM146070
LIMA	1700	300	400	5,47	15,05	WLLIM170030
LIMA	1700	400	600	6,66	18,58	WLLIM170040
LIMA	1700	500	600	7,86	22,10	WLLIM170050
LIMA	1700	600	800	9,05	25,63	WLLIM170060
LIMA	1700	700	800	10,25	29,16	WLLIM170070
LIMA ONE	820	300	200	2,47	6,94	WWLIE082030
LIMA ONE	820	400	200	3,01	8,54	WWLIE082040

Modell	A ↓	B ↔	 [W]	 [dm ²]	 [kg]	Artikelnummer <small>(Konfigurations code s. 664)</small>
LIMA ONE	820	500	300	3,54	10,12	WWLIE082050
LIMA ONE	820	600	400	4,08	11,70	WWLIE082060
LIMA ONE	820	700	400	4,62	13,29	WWLIE082070
LIMA ONE	1140	300	300	3,51	9,78	WWLIE114030
LIMA ONE	1140	400	300	4,28	12,08	WWLIE114040
LIMA ONE	1140	500	400	5,06	14,37	WWLIE114050
LIMA ONE	1140	600	400	5,84	16,67	WWLIE114060
LIMA ONE	1140	700	600	6,61	18,96	WWLIE114070
LIMA ONE	1460	300	300	4,60	12,79	WWLIE146030
LIMA ONE	1460	400	400	5,61	15,78	WWLIE146040
LIMA ONE	1460	500	600	6,63	18,78	WWLIE146050
LIMA ONE	1460	600	600	7,64	21,78	WWLIE146060
LIMA ONE	1460	700	800	8,66	24,78	WWLIE146070
LIMA ONE	1700	300	400	5,40	14,99	WWLIE170030
LIMA ONE	1700	400	600	6,60	18,53	WWLIE170040
LIMA ONE	1700	500	600	7,79	22,05	WWLIE170050
LIMA ONE	1700	600	800	8,99	25,58	WWLIE170060
LIMA ONE	1700	700	800	10,18	29,11	WWLIE170070
MARLIN	600	430	120	1,57	6,10	WLMAR060043
MARLIN	600	530	200	1,76	7,13	WLMAR060053
MARLIN	600	630	200	1,94	8,15	WLMAR060063
MARLIN	780	430	200	2,11	8,33	WLMAR078043
MARLIN	780	530	300	2,38	9,76	WLMAR078053
MARLIN	780	630	300	2,64	11,19	WLMAR078063
MARLIN	1185	430	300	3,25	12,84	WLMAR118043
MARLIN	1185	530	400	3,66	15,08	WLMAR118053
MARLIN	1185	630	600	4,08	17,32	WLMAR118063
MARLIN	1680	430	600	4,66	18,45	WLMAR168043
MARLIN	1680	530	600	5,27	21,70	WLMAR168053
MARLIN	1680	630	800	5,87	24,95	WLMAR168063
MARLIN ONE	780	430	200	2,11	8,33	WWMRN078043
MARLIN ONE	780	530	300	2,38	9,76	WWMRN078053
MARLIN ONE	780	630	300	2,64	11,19	WWMRN078063
MARLIN ONE	1185	430	300	3,25	12,84	WWMRN118043
MARLIN ONE	1185	530	400	3,66	15,08	WWMRN118053
MARLIN ONE	1185	630	600	4,08	17,32	WWMRN118063
MARLIN ONE	1680	430	600	4,66	18,45	WWMRN168043
MARLIN ONE	1680	530	600	5,27	21,70	WWMRN168053
MARLIN ONE	1680	630	800	5,87	24,95	WWMRN168063
MICHELLE	780	400	300	2,84	12,11	WLMIC078040
MICHELLE	780	500	300	3,29	13,72	WLMIC078050
MICHELLE	780	600	400	3,75	15,34	WLMIC078060
MICHELLE	1200	400	400	4,46	19,01	WLMIC120040
MICHELLE	1200	500	600	5,18	21,57	WLMIC120050
MICHELLE	1200	600	600	5,90	24,11	WLMIC120060
MICHELLE	1620	400	600	6,10	25,95	WLMIC162040
MICHELLE	1620	500	800	7,08	29,43	WLMIC162050
MICHELLE	1620	600	800	8,06	32,92	WLMIC162060

Modell	A ↓	B ↔	 [W]	 [dm³]	 [kg]	Artikelnummer <small>(Konfigurations code s. 664)</small>
MIKE	435	430	120	1,25	4,49	WLMIK043043
MIKE	435	530	200	1,41	5,25	WLMIK043053
MIKE	460	230	120	0,92	2,90	WLMIK046023
MIKE	710	230	120	1,40	4,39	WLMIK071023
MIKE	735	430	200	2,07	7,36	WLMIK073043
MIKE	735	530	300	2,34	8,60	WLMIK073053
MIKE	960	230	200	1,89	5,88	WLMIK096023
MIKE	1035	430	300	2,89	10,23	WLMIK103043
MIKE	1035	530	400	3,26	11,95	WLMIK103053
MIKE	1210	230	200	2,38	7,37	WLMIK121023
MIKE	1335	430	400	3,71	13,10	WLMIK133043
MIKE	1335	530	600	4,19	15,30	WLMIK133053
MIKE	1460	230	300	2,86	8,86	WLMIK146023
MIKE	1635	430	600	4,53	15,97	WLMIK163043
MIKE	1635	530	600	5,11	18,64	WLMIK163053
MIKE	1710	230	300	3,35	10,35	WLMIK171023
MIKE ONE	710	230	120	1,34	4,34	WWMIN071023
MIKE ONE	735	430	200	2,00	7,36	WWMIN073043
MIKE ONE	735	530	300	2,27	8,60	WWMIN073053
MIKE ONE	960	230	120	1,82	5,83	WWMIN096023
MIKE ONE	1035	430	300	2,82	10,23	WWMIN103043
MIKE ONE	1035	530	400	3,20	11,95	WWMIN103053
MIKE ONE	1210	230	200	2,31	7,32	WWMIN121023
MIKE ONE	1335	430	400	3,64	13,10	WWMIN133043
MIKE ONE	1335	530	600	4,12	15,30	WWMIN133053
MIKE ONE	1460	230	200	2,80	8,81	WWMIN146023
MIKE ONE	1635	430	600	4,46	15,97	WWMIN163043
MIKE ONE	1635	530	600	5,05	18,64	WWMIN163053
MIKE ONE	1710	230	200	3,29	10,30	WWMIN171023
PERLA E	1360	500	213	–	13,2	WSPER136050
PERLA E	1760	600	284	–	18,1	WSPER176060
POLA	780	500	300	3,34	9,42	WLPAL078050
POLA	780	600	300	3,79	10,75	WLPAL078060
POLA	1180	500	400	5,39	15,21	WLPAL118050
POLA	1180	600	600	6,14	17,41	WLPAL118060
POLA	1580	500	600	7,44	20,99	WLPAL158050
POLA	1580	600	800	8,49	24,08	WLPAL158060
POLA ONE	780	500	300	3,27	9,42	WWPAN078050
POLA ONE	780	600	300	3,72	10,75	WWPAN078060
POLA ONE	1180	500	400	5,33	15,21	WWPAN118050
POLA ONE	1180	600	600	6,07	17,41	WWPAN118060
POLA ONE	1580	500	600	7,38	20,99	WWPAN158050
POLA ONE	1580	600	800	8,42	24,08	WWPAN158060
RETRO	430	504	120	1,05	5,30	WLRE1043050
RETRO	800	504	120	1,88	8,90	WLRE1080050
RETRO	1170	504	200	2,71	12,40	WLRE1117050
RETRO	1540	504	300	3,54	15,90	WLRE1154050
SIMPLE	480	500	120	1,96	5,31	WLSIM048050

Modell	A ↓	B ↔	☺ [W]	📏 [dm ³]	📖 [kg]	Artikelnummer <small>(Konfigurations code s. 664)</small>
SIMPLE	600	500	120	2,45	6,56	WLSIM060050
SIMPLE	720	500	200	2,94	7,83	WLSIM072050
SIMPLE	840	500	200	3,43	9,10	WLSIM084050
SIMPLE	960	500	300	3,92	10,37	WLSIM096050
SIMPLE	1080	500	300	4,41	11,63	WLSIM108050
SIMPLE	1200	500	300	4,90	12,90	WLSIM120050
SIMPLE	1440	500	400	5,89	15,44	WLSIM144050
SIMPLE	1680	500	400	6,87	17,96	WLSIM168050
SIMPLE ONE	720	500	200	2,87	7,77	WWSIE072050
SIMPLE ONE	840	500	200	3,36	9,04	WWSIE084050
SIMPLE ONE	960	500	300	3,85	10,31	WWSIE096050
SIMPLE ONE	1080	500	300	4,34	11,58	WWSIE108050
SIMPLE ONE	1200	500	300	4,83	12,84	WWSIE120050
SIMPLE ONE	1440	500	400	5,81	15,38	WWSIE144050
SIMPLE ONE	1680	500	400	6,79	17,90	WWSIE168050

Temperaturverteilung in einem Elektro-Heizkörper

Die Wärmequelle in einem Elektro-Heizkörper ist eine Heizpatrone, welche in einem der Kollektoren angebracht ist. Das Heizmedium wird vom Heizelement der Heizpatrone erwärmt und steigt im Kollektor nach oben, dadurch wird der Kreislauf (Zirkulation) des Heizmediums eingeleitet. Durch das Aufsteigen der erwärmten Flüssigkeit vermischen sich die Partikel des warmen und des kalten Heizmediums (Diffusionseffekt) und bewegen sich langsam durch die horizontalen Heizkörperrohre. Abgekühlte Flüssigkeit fällt in den unteren Teil des Heizkörpers und steigt nach dem Aufheizen wieder nach oben (siehe Zeichnung). Zusammenfassend gesagt: Der Kollektor, in dem sich die Heizpatrone befindet, wird im-

mer der wärmste Teil des Heizkörpers sein (insbesondere im oberen Heizkörperbereich). Die unteren Rohre hingegen bleiben kälter. Dieses Phänomen ist absolut normal.

Hinweis:

Wird die Heizpatrone direkt im Kollektor installiert (ohne T-Stück oder Ventil) bleiben die beiden unteren Querrohre des Heizkörpers kalt. Dies ist ein zusätzlicher Schutz für das Heizelement und die Steuerung (Sicherheitszone). In Elektro-Heizkörpern können aufgrund des Luftkissens die oberen ein oder zwei Rohre kalt bleiben. Dies tritt vor allem auf, wenn das Gerät mit niedriger Leistung betrieben wird.

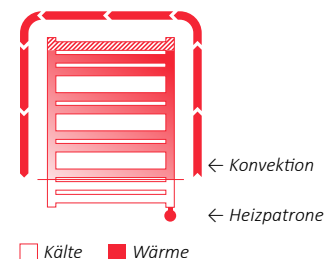

Zubehör

Ablagen und Aufhänger

Ablage EASY

Verfügbares Material



Geeignet für Heizkörper EASY

Größe [mm] (Breite des Heizkörpers)	B [mm]	Material	Artikelnummer Konfigurationscode
200	180	Buche	WRPEAS020 BUK
200	180	Eiche	WRPEAS020 DAB
200	180	Teak	WRPEAS020 TEK

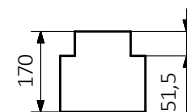
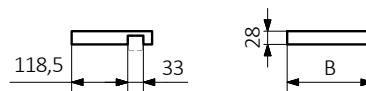

Ablage SIMPLE

Verfügbares Material:



Geeignet für Heizkörper Simple.

Größe [mm] (Breite des Heizkörpers)	B [mm]	Material	Artikelnummer Konfigurationscode
500	440	Buche	WRPSIM050 BUK
500	440	Eiche	WRPSIM050 DAB
500	440	Teak	WRPSIM050 TRK

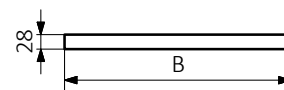
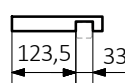

Ablage TRIGA

Verfügbares Material:



Montagehalterungen:

Geeignet für Heizkörper Triga.

Größe [mm] (Breite des Heizkörpers)	B [mm]	Material	Artikelnummer Konfigurationscode
380	410	Buche	WRPTRG038 BUK
380	410	Eiche	WRPTRG038 DAB
380	410	Teak	WRPTRG038 TEK
480	510	Buche	WRPTRG048 BUK
480	510	Eiche	WRPTRG048 DAB
480	510	Teak	WRPTRG048 TEK
580	610	Buche	WRPTRG058 BUK
580	610	Eiche	WRPTRG058 DAB
580	610	Teak	WRPTRG058 TEK
680	710	Buche	WRPTRG068 BUK
680	710	Eiche	WRPTRG068 DAB
680	710	Teak	WRPTRG068 TEK

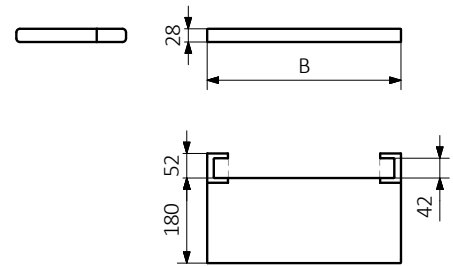

Ablage mit Reling TRIGA

Verfügbares Material:



Montagehalterungen:

Geeignet für Heizkörper Triga.

Größe [mm] (Breite des Heizkörpers)	B [mm]	Material	Artikelnummer Konfigurationscode
380	410	Buche	WRQTRG038 BUK
380	410	Eiche	WRQTRG038 DAB
380	410	Teak	WRQTRG038 TEK
480	510	Buche	WRQTRG048 BUK
480	510	Eiche	WRQTRG048 DAB
480	510	Teak	WRQTRG048 TEK
580	610	Buche	WRQTRG058 BUK
580	610	Eiche	WRQTRG058 DAB
580	610	Teak	WRQTRG058 TEK
680	710	Buche	WRQTRG068 BUK
680	710	Eiche	WRQTRG068 DAB
680	710	Teak	WRQTRG068 TEK

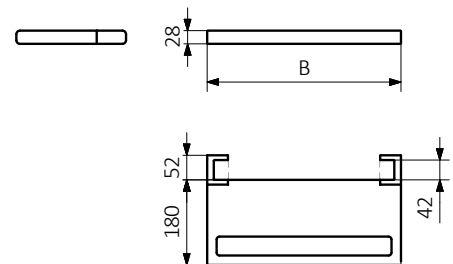

Reling TRIGA

Verfügbares Material: Buche Eiche Teak Montagehalterungen:

Geeignet für Heizkörper Triga.

Größe [mm] (Breite des Heizkörpers)	B [mm]	Material	Artikelnummer Konfigurationscode
380	410	Buche	WRRTRG038 BUK
380	410	Eiche	WRRTRG038 DAB
380	410	Teak	WRRTRG038 TEK
480	510	Buche	WRRTRG048 BUK
480	510	Eiche	WRRTRG048 DAB
480	510	Teak	WRRTRG048 TEK
580	610	Buche	WRRTRG058 BUK
580	610	Eiche	WRRTRG058 DAB
580	610	Teak	WRRTRG058 TEK
680	710	Buche	WRRTRG068 BUK
680	710	Eiche	WRRTRG068 DAB
680	710	Teak	WRRTRG068 TEK

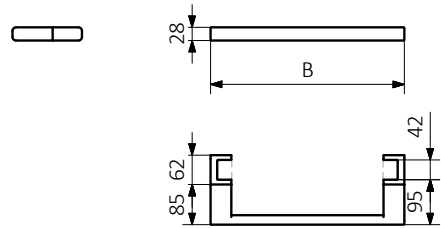

Handtuchhalter HANDY GRIP

Farboptionen:

Geeignet für Heizkörper mit Rundrohrprofilen.
Verpackung enthält 1 Paar (2 Stück) Handtuchhalter.

Farben	Artikelnummer
Weiß	TGWBI010
Chrom	TGWCR008



Handtuchhalter HANDY VIP

Farboptionen: ● ○

Geeignet für Heizkörper mit Rundrohrprofilen
Verpackung enthält 1 Paar (2 Stück) Handtuchhalter.



Farben	Artikelnummer
Weiß	TGWBI005
Chrom	TGWCR005

Handtuchhalter KUKA

Farboptionen: ●

Geeignet für Heizkörper:
Kuka 50 – Sherwood.
Kuka 70 – Cyklon



Größe	Farben	Artikelnummer
50 x 10 mm	Chrom	WRWKUK001 KCRO
70 x 11 mm	Chrom	WRWKUK002 KCRO

Kuka 50

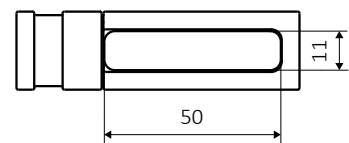

Kuka 70

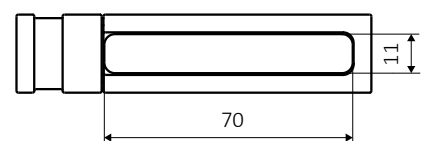

Handtuchhalter Spark

Farboptionen: ●

Geeignet für Heizkörper:
Diamond

Ausführung	Größe	Farben	Artikelnummer
SPARK 1	25 mm	Chrom	WRWSP1025 KCRO
SPARK 2	25 mm	Chrom	WRWSP2025 KCRO
SPARK 3	25 mm	Chrom	WRWSP3025 KCRO



Spark 1

Spark 2

Spark 3

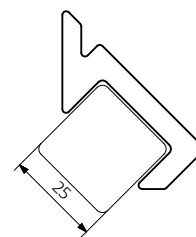
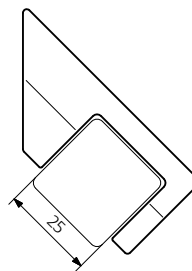
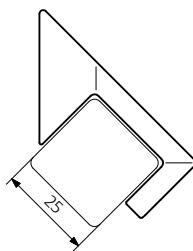

Handtuchhalter Yo!

Geeignet für Heizkörper mit Rundrohrprofilen
Verpackung enthält 1 Paar (2 Stück) Handtuchhalter.

Geeignet für Heizkörper:

Aero H, Aero HG, Alex, Alex One, Domi, Fiona, Fiona One, Lena, Lima, Lima One, Lukka, POC 2, Pola, Pola One, Tytus, Tytus One

Farben	Artikelnummer
Braun	TTSININ0001 SBRZ
Rot	TTSININ0002 SCZE
Grün	TTSININ0003 SZIE
Gelb	TTSININ0004 SZOL
Grau	TTSININ0005 SSZA
Blau	TTSININ0006 SNIE
Weiß	TTSININ0007 SBIA
Schwarz	TTSININ0008 SCZA

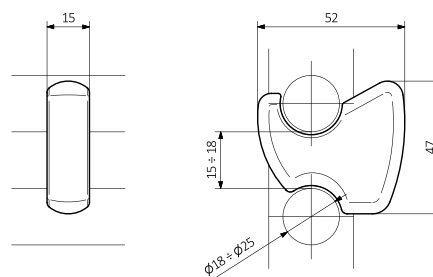

Handtuchhalter ZIP H

Farboptionen: ●

Geeignet für Heizkörper:

Zip H 10 – Dexter, Dexter Pro, Marlin, Mantis, Incorner,
Outcorner, Quadrus Slim, Quadrus Bold, City.

Zip H 20 – Bone.



Größe	Farben	Artikelnummer
10 mm	Chrom	WRWZIP008 KCRO
20 mm	Chrom	WRWZIP010 KCRO

Zip H 10

Zip H 20

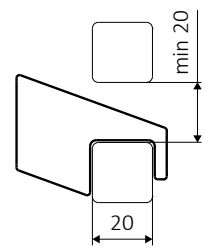
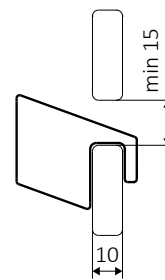

Handtuchhalter ZIP V

Farboptionen: ●

Geeignet für Heizkörper:

Zip V 10 – Nemo

Zip V 20 – Intra, Intra M

Zip V 30 – Angus, Easy, Triga (AW, AN), Sherwood, Simple, ZigZag.

Zip V 40 – Triga.



Größe	Farben	Artikelnummer
10 mm	Chrom	WRWZIP009 KCRO
20 mm	Chrom	WRWZIP011 KCRO
30 mm	Chrom	WRWZIP012 KCRO
40 mm	Chrom	WRWZIP013 KCRO

Zip V 10

Zip V 20

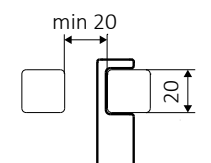
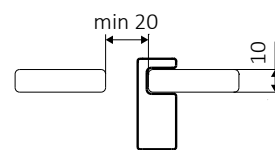

Zip V 30

Zip V 40

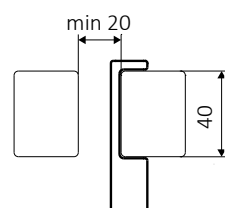
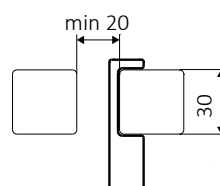

Rohr-Handtuchhalter gebogen BASIC

Farboptionen:

Handtuchhalter für Heizkörper mit gebogenen Rohren.
Erhältlich in zwei Versionen (für 2 Heizkörperbreiten):
400 mm und 500 mm.



Geeignet für Heizkörper mit runden, gebogenen Rohren.

Größe	Farben	Artikelnummer
Ø16/L340 mm	Weiß	TGWBI004
Ø16/L340 mm	Chrom	TGWCR004
Ø16/L430 mm	Weiß	TGWBI002
Ø16/L430 mm	Chrom	TGWCR002

Rohr-Handtuchhalter gerade BASIC

Farboptionen:

Handtuchhalter für Heizkörper mit geraden Rohren. Erhältlich in zwei Varianten (für 2 Heizkörperbreiten): 400 mm und 500 mm.



Geeignet für Heizkörper mit runden, geraden Rohren.

Größe	Farben	Artikelnummer
Ø16/L370 mm	Weiß	TGWBI003
Ø16/L370 mm	Chrom	TGWCR003
Ø16/L460 mm	Weiß	TGWBI001
Ø16/L460 mm	Chrom	TGWCR001

Handtuchhalter SIMPLE

Farboptionen: RAL-Farbpalette oder Sonderfarben ohne Chrom

Geeignet für Heizkörper SIMPLE

Größe	Farben	Artikelnummer
		<i>Konfigurations code s. 666</i>
500 mm	RAL	WRWSIM004

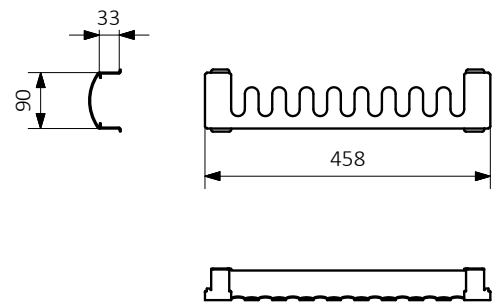
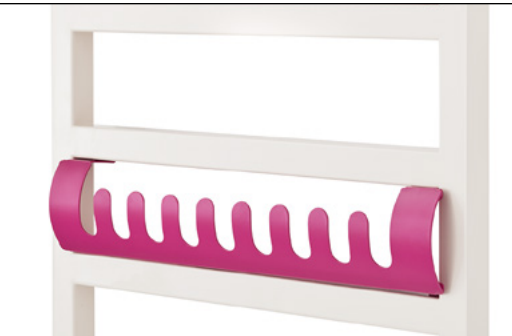

Handtuchhalter CASE SLIM

Farboptionen: RAL-Farbpalette, Chrom oder Sonderfarben

Geeignet für Heizkörper CASE SLIM

Größe	B [mm]	Farben	Artikelnummer
			<i>Konfigurations code s. 666</i>
420 mm	448	RAL/CHROM	WRRCSS042
520 mm	548	RAL/CHROM	WRRCSS052
620 mm	648	RAL/CHROM	WRRCSS062

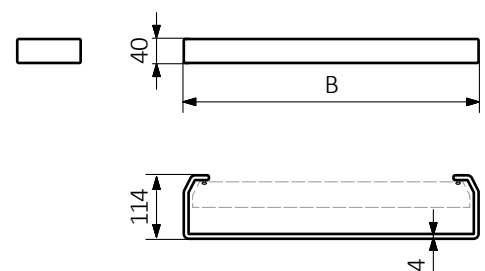

Heizpatronen



Entspricht der EU Direktive
2009/125/WE und 2015/1188



foto. Farbe in der Abbildung: Chrom / Spiralkabel

Funktionalität

Die Elektro-Heizpatrone ONE ermöglicht die Einstellung von 2 unterschiedlichen Heiztemperaturen. Ein elektronischer Temperatursensor sorgt für eine präzise Regelung. Mehrfarbige LED-Diode zur Anzeige der aktuellen Betriebsart. Die Heizpatrone zeichnet sich durch einen sehr geringen Stromverbrauch im Standby-Betrieb aus.

Timer

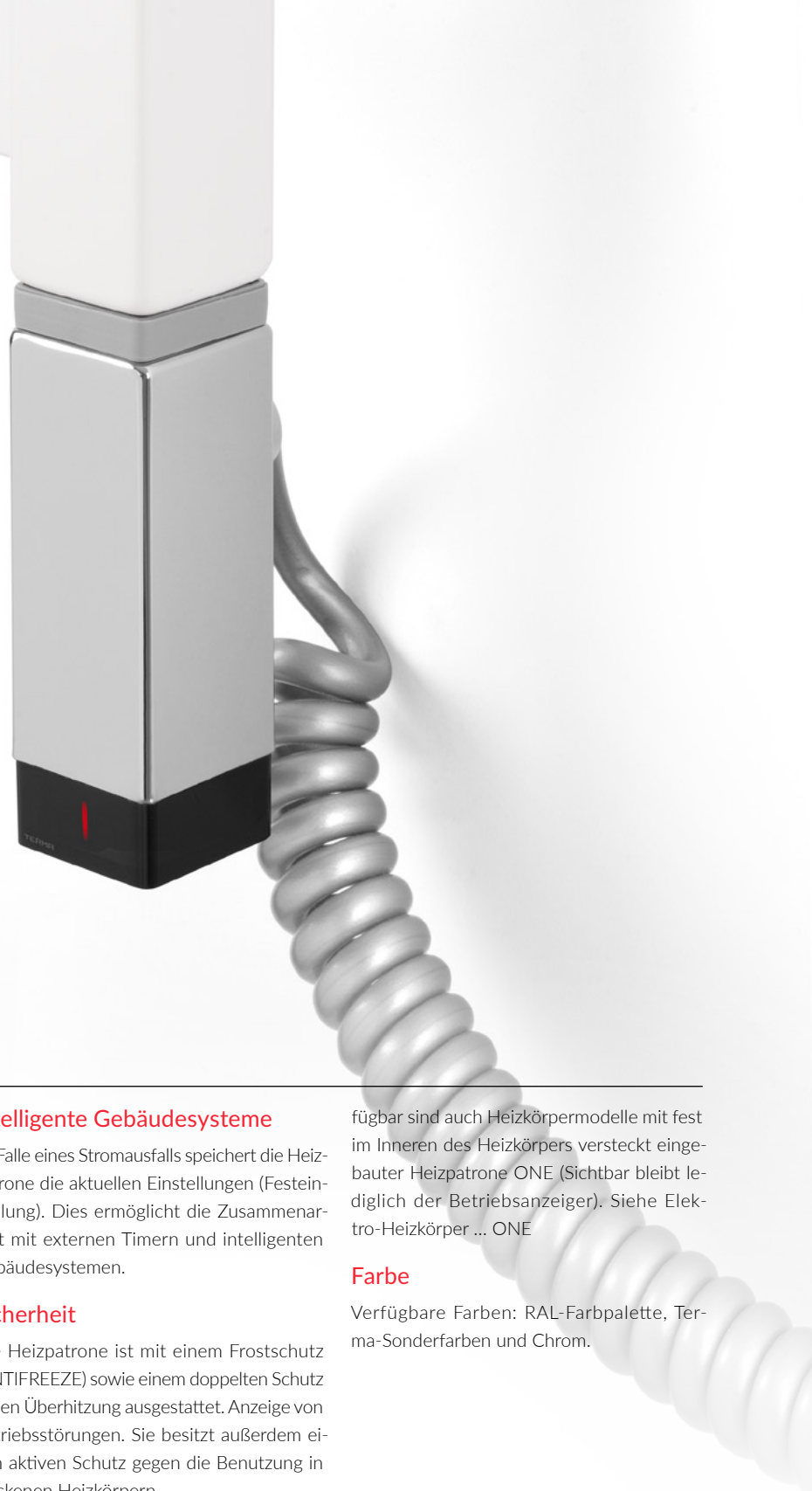
Die Timer-Funktion schaltet die Heizpatrone automatisch nach 2 Stunden ab.

Fernsteuerung

Die Heizpatrone bietet die Möglichkeit für eine IR-Kommunikation mit einer externen Fernsteuerung, wodurch sie weitere, zusätzliche Funktionen erhält. Informationen über die IR-Fernsteuerungen TTIR und DTIR finden Sie auf Seite 632 und 634.

Intelligente Gebäudesysteme

Im Falle eines Stromausfalls speichert die Heizpatrone die aktuellen Einstellungen (Festeinstellung). Dies ermöglicht die Zusammenarbeit mit externen Timern und intelligenten Gebäudesystemen.

Sicherheit

Die Heizpatrone ist mit einem Frostschutz (ANTIFREEZE) sowie einem doppelten Schutz gegen Überhitzung ausgestattet. Anzeige von Betriebsstörungen. Sie besitzt außerdem einen aktiven Schutz gegen die Benutzung in trockenen Heizkörpern.

Design

Die Heizpatrone verfügt über ein pulverbeschichtetes Metall-Gehäuse und ist in 4 unterschiedlichen Formen, passend zur Form des Heizkörpers, erhältlich. Die Heizpatrone besitzt einen versteckten Schalter zum Einschalten und Wechseln der Betriebsart. Ver-

fügbare sind auch Heizkörpermodelle mit fest im Inneren des Heizkörpers versteckt eingebauter Heizpatrone ONE (Sichtbar bleibt lediglich der Betriebsanzeiger). Siehe Elektro-Heizkörper ... ONE

Farbe

Verfügbare Farben: RAL-Farbpalette, Terma-Sonderfarben und Chrom.



KTX 4

① Seite 400



Entspricht der EU Direktive
2009/125/WE und 2015/1188



foto. Farben in der Abbildung: Chrom / gerades Kabel

Funktionalität

Die Heizpatrone bietet 5 unterschiedliche Heiztemperatur-Einstellungen im Bereich von 30°C bis 60°C. Ein elektronischer Temperatursensor sorgt für eine präzise Regelung. Das Gerät zeigt das aktuell eingestellte Temperaturniveau an und den Status von Heiz- und Ruhephase. Die Heizpatrone ist für die Verbindung mit dem Terma-Split-System konzipiert und bietet die Möglichkeit der Verbindung von Heizelement und Steuerung. Informationen über das Heizelement Terma-Split erhalten Sie auf der Seite 602. Die KTX 4 besitzt außerdem einen Echzeit-Zähler für die tatsächliche Heizzeit. Dieser kann für eine bessere Kontrolle der Energiemenge verwendet werden.

Timer

Die erweiterte Timer-Funktion schaltet die Heizpatrone automatisch nach 1, 2, 3 oder 4 Stunden ab.

Fernsteuerung

Die Heizpatrone bietet die Möglichkeit für eine IR-Kommunikation mit einer externen Fernsteuerung, welche die Heizpatrone um weitere Funktionen erweitert. IR-Fernsteuerungen – Modelle TTIR und DTIR finden Sie auf Seite 632 und 634.

Intelligente Gebäudesysteme

Im Falle eines Stromausfalls speichert die Heizpatrone die aktuellen Einstellungen (Festeinstellung). Dies ermöglicht die Zusammenarbeit mit externen Timern und intelligenten Gebäudesystemen.

Sicherheit

Die Heizpatrone ist mit einem Frostschutz (ANTI-FREEZE) ausgestattet. Sie besitzt außerdem einen doppelten Schutz gegen Überhitzung. Anzeige von Betriebsstörungen.

Design

Gut lesbare, einstellige LED-Anzeige in blau. Die Steuerung ist ebenfalls erhältlich in einer Version mit einer Anschlussklemme und einer Kabelblende sowie einem mechanischen Schalter am Gehäuse.

Farbe

Verfügbare Farben: weiß, silber, chrom und schwarz. Bei einer Bestellung von mind. 100 Stück in einer Farbe ist ebenfalls eine Farbe aus der RAL-Farbpalette sowie folgende Sonderfarben möglich: Bronze und Gold.



KTX 4 BLUE

Seite 402



Entspricht der EU Direktive
2009/125/WE und 2015/1188



foto. Farben in der Abbildung: silber / Spiralkabel

Funktionalität

Die volle Funktionalität der Heizpatrone ist über die Steuerungs-App BLUE-Line verfügbar. Dank ihr können sowohl die Heizkörpertemperatur (30-60°C) als auch die Raumtemperatur* (15-30°C) kontrolliert werden oder eine beliebige Anzahl Programme für einen 7-Tagesplan für den Betrieb des Gerätes programmiert werden. Außerdem steht eine erweiterte Timerfunktion zur Verfügung. Die Tasten am Gehäuse ermöglichen eine einfache Einstellung der Arbeitstemperatur und eine einfache Aktivierung der Timerfunktion (bis 4 Stunden). Das Gerät zeigt das aktuell eingestellte Temperaturniveau und den Status von Heiz- und Ruhephase an. Die Heizpatrone ist für die Verbindung mit dem Terma-Split-System konzipiert und bietet die Möglichkeit der Verbindung von Heizelement und Steuerung. Informationen über das Heizelement Terma-Split erhalten Sie auf der Seite 602. Die KTX 4 besitzt außerdem ei-

nen Echtzeit-Zähler für die tatsächliche Heizzeit. Dieser kann für eine bessere Kontrolle der Energiemenge verwendet werden.

**betrifft nicht die MS Version*

Timer

Die erweiterte Timer-Funktion schaltet die Heizpatrone automatisch nach 1, 2, 3 oder 4 Stunden ab.

Fernsteuerung

Die Heizpatrone bietet die Möglichkeit für eine Bluetooth-Kommunikation mit einer Steuerungs-App, welche die Heizpatrone um weitere Funktionen erweitert. Die Steuerungs-App kann kostenlos über den Play-Store oder Apple-Store heruntergeladen werden.

Intelligente Gebäudesysteme

Im Falle eines Stromausfalls speichert die Heizpatrone die aktuellen Einstellungen (Festeinstellung). Dies ermöglicht die Zusammenar-

beit mit externen Timern und intelligenten Gebäudesystemen.

Sicherheit

Die Heizpatrone ist mit einem Frostschutz (ANTIFREEZE) ausgestattet. Sie besitzt außerdem einen doppelten Schutz gegen Überhitzung. Anzeige von Betriebsstörungen.

Design

Gut lesbare, einstellige LED-Anzeige in blau. Die Steuerung ist ebenfalls erhältlich in einer Version mit einer Anschlussklemme und einer Kabelblende sowie einem mechanischen Schalter am Gehäuse.

Farbe

Verfügbare Farben: weiß, silber, chrom und schwarz. Bei einer Bestellung von mind. 100 Stück in einer Farbe ist ebenfalls eine Farbe aus der RAL-Farbpalette sowie folgende Sonderfarben möglich: Bronze und Gold.





foto. Farben in der Abbildung: weiß / Anschlussklemme mit Kabelblende

Funktionalität

Die Heizpatrone bietet die Möglichkeit zur Einstellung der Heiztemperatur im Bereich von 30°C bis 60°C in Schritten von 1°C. Das Gerät zeigt das aktuelle Temperaturniveau sowie den Status von Heiz- und Ruhezeit an. Das Interface der Heizpatrone ermöglicht eine einfache Programmierung und Bedienung. Die Heizpatrone ist für die Verbindung mit dem Terma-Split-System konzipiert und bietet die Möglichkeit der Verbindung von Heizelement und Steuerung. Informationen über das Heizelement Terma-Split finden Sie auf Seite 602.

Timer-Funktion

Der 24-Stunden-Timer ermöglicht die Programmierung von 4 Zeiträumen, in denen die Heizpatrone eine eingestellte Temperatur hält oder ausgeschaltet ist.

Trocken-Funktion

Eine Funktion zur Regelung der Temperatur und Trocknungszeit, nach der die Heizpatrone in ihren vorherigen Zustand zurückkehrt.

Intelligente Gebäudesysteme

Im Falle eines Stromausfalls speichert die Heizpatrone die aktuellen Einstellungen. Dies ermöglicht die Zusammenarbeit mit externen Timern und intelligenten Gebäudesystemen.

Sicherheit

Die Heizpatrone ist mit einem Frostschutz (ANTIFREEZE) sowie einem doppelten Schutz gegen Überhitzung ausgestattet. Anzeige von Betriebsstörungen. Sie besitzt außerdem einen aktiven Schutz gegen die Benutzung in trockenen Heizkörpern.

Design

Gut lesbare LED-Anzeige mit Uhrzeit. Die Steuerung ist ebenfalls erhältlich in einer Version mit einer Anschlussklemme und einer Kabelblende sowie einem mechanischen Schalter am Gehäuse.

Farben

Verfügbare Farben: weiß, silber, chrom und schwarz. Bei einer Bestellung von mind. 100 Stück in einer Farbe ist ebenfalls eine Farbe aus der RAL-Farbpalette sowie folgende Sonderfarben möglich: Bronze und Gold.





fot. Farbe in der Abbildung: schwarz / Spiralkabel

Funktionalität

Die Heizpatrone bietet 5 unterschiedliche Heiztemperatur-Einstellungen im Bereich von 30°C bis 60°C. Ein elektronischer Temperatursensor sorgt für eine präzise Regelung. Das Gerät zeigt das aktuell eingestellte Temperaturniveau an. Die Heizpatrone ist für die Verbindung mit dem Terma-Split-System konzipiert und bietet die Möglichkeit der Verbindung von Heizelement und Steuerung. Informationen über das Heizelement Terma-Split finden Sie auf Seite 602.

Timer

Bei der Timer-Funktion hält das Gerät den aktuell eingestellten Zustand für die nächsten 2 Stunden und schaltet danach in den gegenteiligen Zustand. Verwenden Sie diese Funktion der Heizpatrone zum Heizen, dann heizt das Gerät in der gewählten

Temperaturstufe für weitere 2 Stunden und schaltet sich danach ab. Ist die Heizpatrone bei Aktivierung der Timer-Funktion ausgeschaltet, dann schaltet sie sich nach Ablauf der 2 Stunden ein.

Intelligente Gebäudesysteme

Im Falle eines Stromausfalls speichert die Heizpatrone die aktuellen Einstellungen (Festeinstellung). Dies ermöglicht die Zusammenarbeit mit externen Timern und intelligenten Gebäudesystemen.

Sicherheit

Die Heizpatrone ist mit einem Frostschutz (ANTIFREEZE) sowie einem doppelten Schutz gegen Überhitzung ausgestattet. Anzeige von Betriebsstörungen.

Design

Einfach zu bedienendes Interface. Die Steuerung ist ebenfalls erhältlich in einer Version mit einer Anschlussklemme und einer Kabelblende sowie einem mechanischen Schalter am Gehäuse.

Farben

Verfügbare Farben: weiß, silber, chrom und schwarz. Bei einer Bestellung von mind. 100 Stück in einer Farbe ist ebenfalls eine Farbe aus der RAL-Farbpalette sowie folgende Sonderfarben möglich: Bronze und Gold.





foto. Farben in der Abbildung: silber / Spiralkabel

Funktionalität

Die Heizpatrone bietet zwei Einstellungen: 50% und 100% der nominalen Leistung. Die Heizpatrone ist für die Verbindung mit dem Terma-Split-System konzipiert und bietet die Möglichkeit der Verbindung von Heizelement und Steuerung. Informationen über das Heizelement Terma-Split finden Sie auf Seite 602.

Intelligente Gebäudesysteme

Im Falle eines Stromausfalls speichert die Heizpatrone die aktuellen Einstellungen (Festeinstellung). Dies ermöglicht die Zusammenarbeit mit externen Timern und intelligenten Gebäudesystemen.

Sicherheit

Die Heizpatrone ist mit einem Frostschutz (ANTIFREEZE) sowie einem doppelten Schutz gegen Überhitzung ausgestattet. Anzeige von Betriebsstörungen.

Design

Große, ergonomische Tasten ermöglichen eine einfache Bedienung. Die Steuerung ist ebenfalls erhältlich in einer Version mit einer Anschlussklemme und einer Kabelblende sowie einem mechanischen Schalter am Gehäuse.

Farben

Verfügbare Farben: weiß, silber, chrom und schwarz. Bei einer Bestellung von mind. 100 Stück in einer Farbe ist ebenfalls eine Farbe aus der RAL-Farbpalette sowie folgende Sonderfarben möglich: Bronze und Gold.





fol. Farben in der Abbildung: Chrom / gerades Kabel

Funktionalität

Die volle Funktionalität der Heizpatrone ist über die Steuerungs-App BLUE-Line verfügbar. Dank ihr können sowohl die Heizkörpertemperatur (30-60°C) als auch die Raumtemperatur (15-30°C) kontrolliert werden oder eine beliebige Anzahl Programme für einen 7-Tagesplan für den Betrieb des Gerätes programmiert werden. Außerdem steht eine erweiterte Timerfunktion zur Verfügung. Die Tasten am Gehäuse ermöglichen eine einfache Einstellung der Arbeitstemperatur und eine einfache Aktivierung der Timerfunktion (bis 2 Stunden). Das Gerät zeigt das eingestellte und das aktuelle Temperaturniveau. Sie zeichnet sich durch einen sehr geringen Stromverbrauch im Standby-Betrieb aus.

Trocken-Funktion

Die Funktion ermöglicht die Verwendung einer beliebigen Temperaturstufe für 2 Stunden. Danach schaltet die Heizpatrone in ihren vorherigen Zustand zurück.

Intelligente Gebäudesysteme

Im Falle eines Stromausfalls speichert die Heizpatrone die aktuellen Einstellungen (Festeinstellung). Dies ermöglicht die Zusammenarbeit mit externen Timern und intelligenten Gebäudesystemen.

Sicherheit

Die Heizpatrone ist mit einem Frostschutz (ANTIFREEZE) sowie einem doppelten Schutz gegen Überhitzung ausgestattet. Anzeige von Betriebsstörungen. Sie besitzt außerdem einen aktiven Schutz gegen die Benutzung in trockenen Heizkörpern.

Design

Es besteht die Auswahl zwischen einer Version mit Spiralkabel und Stecker, geradem Kabel mit Stecker sowie geradem Kabel ohne Stecker, dafür mit einer Kabelblende für das Netzkabel.

Farben

Verfügbare Farben: weiß, silber, chrom und schwarz. Bei einer Bestellung von mind. 100 Stück in einer Farbe ist ebenfalls eine Farbe aus der RAL-Farbpalette sowie folgende Sonderfarben möglich: Bronze und Gold.





Entspricht der EU Direktive
2009/125/WE und 2015/1188



foto. Farben in der Abbildung: Chrom / gerades Kabel

Funktionalität

Die Heizpatrone bietet 5 unterschiedliche Heiztemperatur-Einstellungen im Bereich von 30°C bis 60°C. Ein elektronischer Temperatursensor sorgt für eine präzise Regelung. Das Gerät zeigt das eingestellte und das aktuelle Temperaturniveau. Sie zeichnet sich durch einen sehr geringen Stromverbrauch im Standby-Betrieb aus.

Trocken-Funktion

Die Funktion ermöglicht die Verwendung einer beliebigen Temperaturstufe für 2 Stunden. Danach schaltet die Heizpatrone in ihren vorherigen Zustand zurück.

Fernsteuerung

Die Heizpatrone bietet die Möglichkeit für eine IR-Kommunikation mit einer externen Fernsteuerung, welche die Heizpatrone um

weitere Funktionen erweitert. IR-Fernsteuerungen – Modelle TTIR und DTIR finden Sie auf Seite 632 und 634.

Intelligente Gebäudesysteme

Im Falle eines Stromausfalls speichert die Heizpatrone die aktuellen Einstellungen (Festeinstellung). Dies ermöglicht die Zusammenarbeit mit externen Timern und intelligenten Gebäudesystemen.

Sicherheit

Die Heizpatrone ist mit einem doppelten Schutz gegen Überhitzung ausgestattet und verfügt über einen aktiven Schutz vor Benutzung in einem trockenen Heizkörper. Das Antifreeze-Programm verhindert ein Einfrieren des Heizmediums im Heizkörper. Die Heizpatrone zeigt die aktuelle Betriebsart und mögliche Fehlermeldungen an.

Design

Es besteht die Auswahl zwischen einer Version mit Spiralkabel und Stecker, geradem Kabel mit Stecker sowie geradem Kabel ohne Stecker, dafür mit einer Kabelblende für das Netzkabel.

Farben

Verfügbare Gehäusefarben: weiß, silber, chrom und schwarz. Bei einer Bestellung von mind. 100 Stück in einer Farbe ist ebenfalls eine Farbe aus der RAL-Farbpalette sowie folgende Sonderfarben möglich: Bronze und Gold.



MOA BLUE

① Seite 414



Entspricht der EU Direktive
2009/125/WE und 2015/1188



foto. Farben in der Abbildung: silber / gerades Kabel

Funktionalität

Die volle Funktionalität der Heizpatrone ist über die Steuerungs-App BLUE-Line verfügbar. Dank ihr können sowohl die Heizkörpertemperatur (30-60°C) als auch die Raumtemperatur (15-30°C) kontrolliert werden oder eine beliebige Anzahl Programme für einen 7-Tagesplan für den Betrieb des Gerätes programmiert werden. Außerdem steht eine erweiterte Timerfunktion zur Verfügung. Die Tasten am Gehäuse ermöglichen eine einfache Einstellung der Arbeitstemperatur und eine einfache Aktivierung der Timerfunktion (bis 2 Stunden). Das Gerät zeigt das eingestellte und das aktuelle Temperaturniveau. Sie zeichnet sich durch einen sehr geringen Stromverbrauch im Standby-Betrieb aus.

Trocken-Funktion

Die Funktion ermöglicht die Verwendung einer beliebigen Temperaturstufe für 2 Stunden.

Danach schaltet die Heizpatrone in ihren vorherigen Zustand zurück.

Fernsteuerung

Die Heizpatrone bietet die Möglichkeit für eine Bluetooth-Kommunikation mit einer Steuerungs-App, welche die Heizpatrone um weitere Funktionen erweitert. Die Steuerungs-App kann kostenlos über den Play-Store oder Apple-Store heruntergeladen werden.

Intelligente Gebäudesysteme

Im Falle eines Stromausfalls speichert die Heizpatrone die aktuellen Einstellungen (Festeinstellung). Dies ermöglicht die Zusammenarbeit mit externen Timern und intelligenten Gebäudesystemen.

Sicherheit

Die Heizpatrone ist mit einem doppelten Schutz gegen Überhitzung ausgestattet und

verfügt über einen aktiven Schutz vor Benutzung in einem trockenen Heizkörper. Das Antifreeze-Programm verhindert ein Einfrieren des Heizmediums im Heizkörper. Die Heizpatrone zeigt die aktuelle Betriebsart und mögliche Fehlermeldungen an.

Design

Es besteht die Auswahl zwischen einer Version mit Spiralkabel und Stecker, geradem Kabel mit Stecker sowie geradem Kabel ohne Stecker, dafür mit einer Kabelblende für das Netzkabel.

Farben

Verfügbare Gehäusefarben: weiß, silber, chrom und schwarz. Bei einer Bestellung von mind. 100 Stück in einer Farbe ist ebenfalls eine Farbe aus der RAL-Farbpalette sowie folgende Sonderfarben möglich: Bronze und Gold.





foto. Farben in der Abbildung: silber / gerades Kabel

Funktionalität

Praktische Heizpatrone mit einer standardmäßig eingestellten Heiztemperatur von konstant 48°C. Es besteht die Möglichkeit andere Temperaturniveaus zu programmieren. Die Heizpatrone hat einen sehr geringen Stromverbrauch im Standby-Modus.

Timer

Eine erweiterte Timer-Funktion schaltet das Gerät nach 1, 2, 3, 4 oder 5 Stunden automatisch ab.

Intelligente Gebäudesysteme

Im Falle eines Stromausfalls speichert die Heizpatrone die aktuellen Einstellungen (Festeinstellung). Dies ermöglicht die Zusammenarbeit mit externen Timern und intelligenten Gebäudesystemen.

Sicherheit

Die Heizpatrone ist mit einem Frostschutz (ANTIFREEZE) sowie einem doppelten Schutz gegen Überhitzung ausgestattet. Anzeige von Betriebsstörungen. Sie besitzt außerdem einen aktiven Schutz gegen die Benutzung in trockenen Heizkörpern.

Design

Es besteht die Auswahl zwischen einer Version mit Spiralkabel und Stecker, geradem Kabel mit Stecker sowie geradem Kabel ohne Stecker, dafür mit einer Kabelblende für das Netzkabel.

Farben

Verfügbare Gehäusefarben: weiß, silber, chrom und schwarz. Bei einer Bestellung von mind. 100 Stück in einer Farbe ist ebenfalls eine Farbe aus der RAL-Farbpalette sowie folgende Sonderfarben möglich: Bronze und Gold.





fot. Farben in der Abbildung: Chrom / Spiralkabel

Funktionalität

Die Heizpatrone bietet 5 unterschiedliche Heiztemperaturen im Bereich von 30°C bis 60°C. Ein elektronischer Temperatursensor sorgt für eine präzise Regelung. Das Gerät zeigt das eingestellte und das aktuelle Temperaturniveau.

Intelligente Gebäudesysteme

Im Falle eines Stromausfalls speichert die Heizpatrone die aktuellen Einstellungen (Festeinstellung). Dies ermöglicht die Zusammenarbeit mit externen Timern und intelligenten Gebäudesystemen.

Sicherheit

Die Heizpatrone ist mit einem Frostschutz (ANTIFREEZE) sowie einem doppelten Schutz gegen Überhitzung ausgestattet. Anzeige von Betriebsstörungen. Sie besitzt außerdem einen aktiven Schutz gegen die Benutzung in trockenen Heizkörpern.

Design

Es besteht die Auswahl zwischen einer Version mit Spiralkabel und Stecker, geradem Kabel mit Stecker sowie geradem Kabel ohne Stecker, dafür mit einer Kabelblende für das Netzkabel.

Farben

Verfügbare Farben: weiß, silber, chrom und schwarz. Bei einer Bestellung von mind. 100 Stück in einer Farbe ist ebenfalls eine Farbe aus der RAL-Farbpalette sowie folgende Sonderfarben möglich: Bronze und Gold.





foto. Farben in der Abbildung: weiß mit grauem Ring / gerades Kabel

Funktionalität

Die Heizpatrone ermöglicht die Auswahl zwischen 2 unterschiedlichen Temperaturebenen, bei gleichzeitiger Anzeige der aktuellen Einstellung: 50°C oder 65°C.

Intelligente Gebäudesysteme

Im Falle eines Stromausfalls speichert die Heizpatrone die aktuellen Einstellungen (Festeinstellung). Dies ermöglicht die Zusammenarbeit mit externen Timern und intelligenten Gebäudesystemen.

Sicherheit

Die Heizpatrone ist mit einem doppelten Schutz gegen Überhitzung ausgestattet.

Design

Das kleine Gehäuse und die universelle Form erinnern an einen Wassertropfen. Die Heizpatrone besitzt einen beweglichen Ring am Gehäuse um das Gerät einzuschalten und die Heiztemperatur einzustellen.

Farben

Verfügbare Farben: weiß, silber, chrom und schwarz.





fol. Farben in der Abbildung: weiß / Spiralkabel

Funktionalität

Die Heizpatrone hält eine gleichmäßige Temperatur von 65°C. Eine LED-Diode zeigt die Verbindung mit dem Stromnetz. Das Gerät verfügt über einen Bimetall-Temperatursensor.

Intelligente Gebäudesysteme

Das Gerät kann mit externen Timern oder intelligenten Gebäudesystemen zusammenarbeiten.

Sicherheit

Die Heizpatrone ist mit einem doppelten Schutz gegen Überhitzung ausgestattet.

Design

Kleines, originelles, kugelförmiges Steuerunggehäuse. Die Heizpatrone besitzt keinen Schalter am Gehäuse, ist jedoch in einer Version mit Schalter am Stecker verfügbar.

Farben

Verfügbare Farben: weiß, silber, chrom und schwarz.



fot. Farben in der Abbildung: Edelstahl; gerades Kabel

Funktionalität

Die einfachste Heizpatrone ohne Temperaturregelung mit einem Überhitzungsschutz für ungewöhnliche Situationen. Das Gerät verfügt über einen Bimetall-Temperatursensor. Die Heizpatrone ist erhältlich bis zu einer Leistung von 1500 W.

Intelligente Gebäudesysteme

Das Gerät kann mit externen Timern oder intelligenten Gebäudesystemen zusammenarbeiten.

Sicherheit

Die Heizpatrone besitzt einen außerordentlich hohen Schutz gegen Feuchtigkeit und eine Thermosicherung gegen Betriebsstörungen.

Design

Edelstahlgehäuse. Die Heizpatrone besitzt keinen Schalter am Gehäuse, ist jedoch in einer Version mit Schalter am Stecker verfügbar.

Farben

Verfügbare Farben: Edelstahl.



Merkmale und Funktionen

	SIM	REG 3	REG 2	MEG	MOA	MOA IR
Art der Regelung	HK Temp.	HK Temp.	HK Temp./ Raumtemp.	HK Temp.	HK Temp.	HK Temp./ Raumtemp. ^{[1][2]}
Einstellbereich/Anzahl der Stufen	65°C/1	50-65°C/2	65°C / 1	30-60°C / 5	30-60°C / 5	30-60°C / 5
Symmetrisches Gehäuse (Montage auf linker und rechter HK-Seite möglich)	✓	✓	✓	✓	✓	✓
Anschlussart	P/R	P/W/U	T/R	P/W/U	P/W/U	P/W/U
Geräteschutzklasse	Klasse I	Klasse I	Klasse I	Klasse I	Klasse I	Klasse I
Gehäuseschutzstufe	IP67	IPx5	IPx5	IPx4	IPx5	IPx5
Getrenntes Heizelement (Terma-Split System)	–	–	–	–	–	–
Elektronischer Temperatursensor	–	–	–	✓	✓	✓
Verfügbare Heizleistungen	100-1500 W	120-1200 W	120-1200 W	120-1200 W	120-1200 W	120-1200 W
Boosterfunktion / Anzahl Stufen	–	–	–	–	2h/-	2h/-
Tagestimer-Funktion	–	–	–	–	–	✓ ^[1]
Wochentimer-funktion	–	–	–	–	–	✓ ^[2]
Drahtloses Kommunikationsmodul	–	–	–	–	–	IR
Aktiver Schutz vor Benutzung in trockenem Heizkörper	–	–	–	✓	✓	✓
Echtzeitähler für tatsächliche Heizzeit	–	–	–	–	–	–
ANTIFREEZE, die das Heizmedium vor dem Einfrieren schützt	–	–	–	✓	✓	✓
Doppelte Sicherung gegen Überhitzung (Überhitzung und Feuer)	✓	✓	✓	✓	✓	✓
Entspricht der EU Direktive 2009/125/WE und 2015/1188	–	–	–	–	–	✓ ^[2]

Legende:

HK Temp. – Heizkörpertemperatur
 HK Temp./Raumtemp. – Heizkörpertemperatur / Raumtemperatur
 Raum Temp. – Raumtemperatur

P – gerades Kabel ohne Stecker
 R – gerades Kabel mit Stecker / Schalter
 S – Anschlussklemme mit Kabelblende
 T – Spiralkabel mit Stecker / Schalter
 U – Spiralkabel mit Stecker
 W – gerades Kabel mit Stecker

MOA Blue	DRY	KTX 1	KTX 2	KTX 3	KTX 4	KTX 4 Blue	One	DTIR	TTIR
HK Temp./ Raumtemp.	HK Temp.	Heizleistung	HK Temp.	HK Temp.	HK Temp./ Raumtemp. ^{[1][2]}	HK Temp./ Raumtemp.	HK Temp./ Raumtemp. ^{[1][2]}	Raumtemperatur	
15-30°C / 5 ^[4] 30-60°C / 5 ^[4]	48°C (42-60)	-/2 ^[3]	30-60°C / 5	30-60°C / 30	30-60°C / 5	15-30°C / 5 ^[4] 30-60°C / 5 ^[4]	45-60°C / 2	5-30°C	10-30°C
✓	✓	✓	✓	✓	✓	✓	✓ ^[6]	–	–
P/W/U	P/W/U	P/W/U/S	P/W/U/S	P/W/U/S	P/W/U/S	P/W/U/S	P/W/U	–	–
Klasse I	Klasse I	Klasse I	Klasse I	Klasse I	Klasse I	Klasse I	Klasse I	Klasse III	
IPx5	IPx5	IPx4	IPx5 ^[7]	IPx5 ^[7]	IPx5 ^[7]	IPx5 ^[7]	IPx5	IP30	
–	–	✓	✓	✓	✓	✓	–	–	
✓	✓	✓	✓	✓	✓	✓	✓	✓	
120-1000 W	120-1000 W	120-1000 W	120-1000 W	120-1000 W	120-1000 W	120-1000 W	120-1000 W	–	
24h/48	5h/5	–	2h/-	4h/8	4h/4	24h/48	2h/-	4h/16	4h/8
✓	–	–	–	✓ ^[5]	✓ ^[1]	✓	✓ ^[2]	✓	–
✓	–	–	–	–	✓ ^[2]	✓	✓ ^[2]	–	✓
BLE	–	–	–	–	IR	BLE	IR	IR	IR
✓	✓	–	–	✓	✓	✓	✓	–	
–	–	–	–	–	✓	✓	–	–	
✓	✓	✓	✓	✓	✓	✓	✓	✓	
✓	✓	✓	✓	✓	✓	✓	✓	–	
✓	–	–	–	–	✓ ^[2]	✓	✓ ^[2]	–	

¹ Nur wenn die Heizpatrone mit der Fernsteuerung DT-IR verbunden ist

² Nur wenn die Heizpatrone mit der Fernsteuerung TT-IR verbunden ist

³ Regulierung der Heizleistung 50/100%

⁴ Bluetooth Steuerungs-App ermöglicht die Regulierung der Temperatur in 1°C Schritten

⁵ Vereinfachter Tagerstimer, 4-Zonen

⁶ Betrifft nicht die trapezförmige Version und D-Profil

⁷ Ausführung mit Anschluss S hat IPx4

Heizpatronen

Technische Informationen

Funktionen und Eigenschaften:

Funktionalität

Die Elektro-Heizpatrone ONE ermöglicht die Einstellung von 2 unterschiedlichen Heiztemperaturen. Ein elektronischer Temperatursensor sorgt für eine präzise Regelung. Mehrfarbige LED-Diode zur Anzeige der aktuellen Betriebsart. Die Heizpatrone zeichnet sich durch einen sehr geringen Stromverbrauch im Standby-Betrieb aus.

Timer

Die Timer-Funktion schaltet die Heizpatrone automatisch nach 2 Stunden ab.

Fernsteuerung

Die Heizpatrone bietet die Möglichkeit für eine IR-Kommunikation mit einer externen Fernsteuerung, wodurch sie weitere, zusätzliche Funktionen erhält. Informationen über die IR-Fernsteuerungen TTIR und DTIR finden Sie auf Seite 632 und 634.

Intelligente Gebäudesysteme

Im Falle eines Stromausfalls speichert die Heizpatrone die aktuellen Einstellungen (Festeinstellung). Dies ermöglicht die Zusammenarbeit mit externen Timern und intelligenten Gebäudesystemen.

Sicherheit

Die Heizpatrone ist mit einem Frostschutz (ANTIFREEZE) sowie einem doppelten Schutz gegen Überhitzung ausgestattet. Anzeige von Betriebsstörungen. Sie besitzt außerdem einen aktiven Schutz gegen die Benutzung in trockenen Heizkörpern.

Design

Die Heizpatrone verfügt über ein pulverbeschichtetes Metall-Gehäuse und ist in 4 unterschiedlichen Formen, passend zur Form des Heizkörpers, erhältlich. Die Heizpatrone besitzt einen versteckten Schalter zum Ein-

schalten und Wechseln der Betriebsart. Verfügbar sind auch Heizkörpermodelle mit fest im Inneren des Heizkörpers versteckt eingebauter Heizpatrone ONE (Sichtbar bleibt lediglich der Betriebsanzeiger). Siehe Elektro-Heizkörper ... ONE

Farbe

Verfügbare Farben: RAL-Farbpalette, Terra-Sonderfarben und Chrom.

Verfügbare Leistungen

120, 200, 300, 400, 600, 800, 1000 W.

Technische Daten:

- Stromversorgung:** 230 V / 50 Hz
- Geräteschutzklasse:** Klasse I
- Heizkörperanschluss:** G 1/2"
- Gehäuseschutzstufe [IP]:** IPx5

Konfigurationstabelle:

Beispiel Bestellcode: **WE**^{Leistungscod}**ODL**^{Modellcode}**04**^{Verpackungscod}**T**^{Farbcode}**CRO**^{Kabeltypcode}**W**

Codeelemente sind blau markiert.

Modell	Leistung [W]	Verpackung	Farben	Kabeltyp
WE ODL ONE D links	01 120	T Tube (Rohr)	916 Weiß	W Gerades Kabel mit Stecker
ODP ONE D rechts	02 200		CRO Chrom	P Gerades Kabel ohne Stecker
OKX ONE 30x30	03 300		oder andere Farben gemäß Farbpalette auf S. 12	U Spiralkabel mit Stecker
OPX ONE 30x40	04 400			
OTL ONE T links	06 600			
OTP ONE T rechts	08 800			
	10 1000			

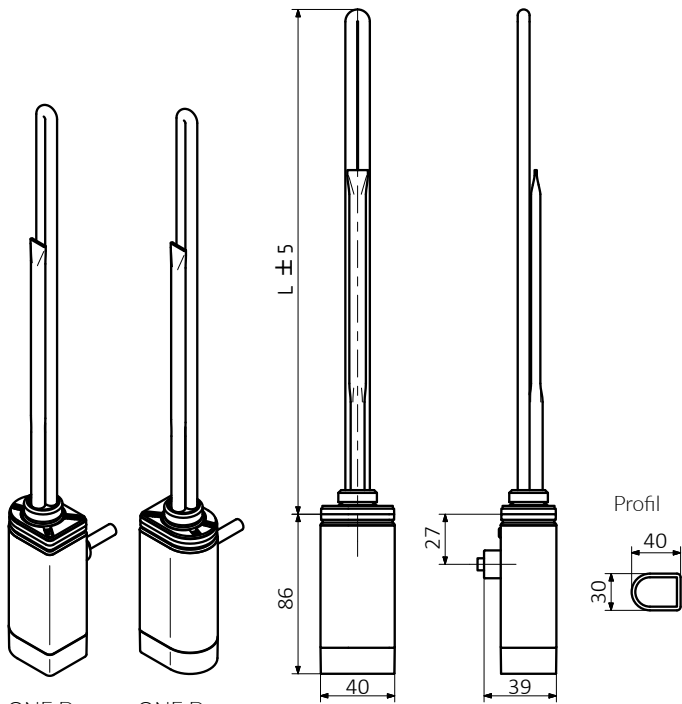

ONE D links ONE D rechts

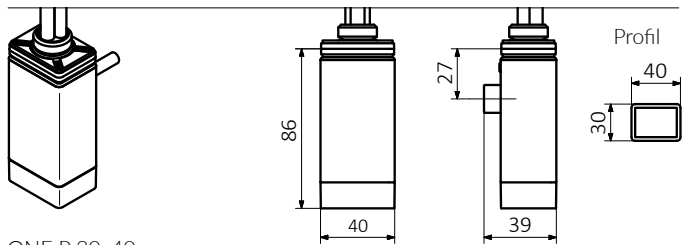

ONE P 30x40

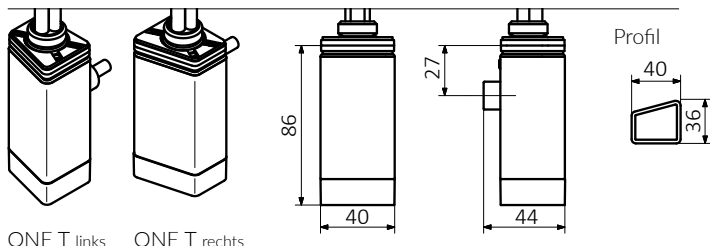

ONE T links ONE T rechts

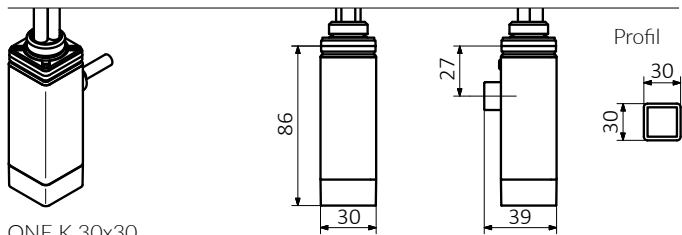

ONE K 30x30

Gerades Kabel ohne Stecker

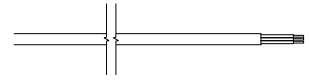

Gerades Kabel mit Stecker

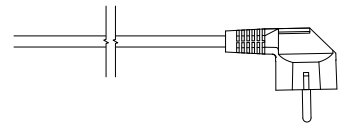

Spiralkabel mit Stecker

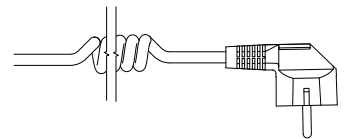

L [mm]	310	270	295	330	360	470	560
Leistung [W]	120	200	300	400	600	800	1000

Terma-Split TS 1

Funktionen und Eigenschaften:

Der einzigartige Wert der ausgewählten Heizpatrone aus dem Angebot der Firma Terma ist die Verbindung mit dem Terma-Split. Die innovative Lösung beruht auf der Trennung zwischen Heizelement und Steuerung. Das Heizelement selbst schrauben wir, mit Hilfe eines passenden Schraubenschlüssels (Größe 24) in einen „traditionellen“ Heizkörper, als nächstes verbinden wir es mit einer Steuerung der KTX-Serie, welche auf den Steckverbinder aufgesetzt wird. Nach außen bleibt nur das Steuergerät sichtbar, da der Steckverbinder komplett im Gehäuse „versteckt“ ist

Vorteile bei der Verwendung des Terma-Split:

- Einfache und sichere Montage.
- Jederzeit die Möglichkeit die Steuerung zu wechseln ohne Demontage des Heizelements.
- Jederzeit die Möglichkeit die Steuerung zu entfernen, z.B. bei Renovierungsarbeiten.
- Die Möglichkeit den Winkel der Steuerung beliebig zu verstellen (Drehbereich 340°) damit die Anzeige nach vorne zeigt.
- Verwendung eines Heizelements mit beliebiger Leistung von 120 bis 1000 W (mit jeder Steuerung aus der KTX-Serie).

Technische Daten:

Geräteschutzklasse: Klasse I
Stromversorgung: 230 V / 50 Hz

Konfigurationstabelle:

Beispiel Bestellcode: **WE** ^{Leistungscodes} **TS1** ^{Modellcode} **04** ^{Verpackungscodes} **K** ^{Kabeltypcode} **---** **D**

Codeelemente sind blau markiert.

	Modell	Leistung [W]	Verpackung	Farben	Verbindung Split
WE	TS1 Terma Split	01 120	K Karton	--- Fehlen	D Verbindung Split Klasse I
		02 200			
		03 300			
		04 400			
		06 600			
		08 800			
		10 1000			

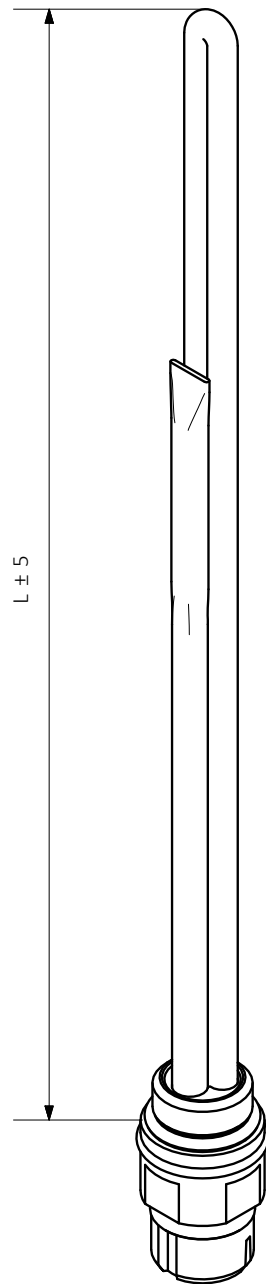

L [mm]	325	285	310	345	375	485	575
Leistung [W]	120	200	300	400	600	800	1000

Funktionen und Eigenschaften:

Funktionalität

Die Heizpatrone bietet 5 unterschiedliche Heiztemperatur-Einstellungen im Bereich von 30°C bis 60°C. Ein elektronischer Temperatursensor sorgt für eine präzise Regelung. Das Gerät zeigt das aktuell eingestellte Temperaturniveau an und den Status von Heiz- und Ruhephase. Die Heizpatrone ist für die Verbindung mit dem Terma-Split-System konzipiert und bietet die Möglichkeit der Verbindung von Heizelement und Steuerung. Informationen über das Heizelement Terma-Split erhalten Sie auf der Seite 602. Die KTX 4 besitzt außerdem einen Echzeit-Zähler für die tatsächliche Heizzeit. Dieser kann für eine bessere Kontrolle der Energiemenge verwendet werden.

Timer

Die erweiterte Timer-Funktion schaltet die Heizpatrone automatisch nach 1, 2, 3 oder 4 Stunden ab.

Fernsteuerung

Die Heizpatrone bietet die Möglichkeit für eine IR-Kommunikation mit einer externen Fernsteuerung, welche die Heizpatrone um weitere Funktionen erweitert. IR-Fernsteuerungen – Modelle TTIR und DTIR finden Sie auf Seite 632 und 634.

Intelligente Gebäudesysteme

Im Falle eines Stromausfalls speichert die Heizpatrone die aktuellen Einstellungen (Festeinstellung). Dies ermöglicht die Zusammenarbeit mit externen Timern und intelligenten Gebäudesystemen.

Sicherheit

Die Heizpatrone ist mit einem Frostschutz (ANTI-FREEZE) ausgestattet. Sie besitzt außerdem einen doppelten Schutz gegen Überhitzung. Anzeige von Betriebsstörungen.

Design

Gut lesbare, einstellige LED-Anzeige in blau. Die Steuerung ist ebenfalls erhältlich in einer Version mit einer Anschlussklemme und einer Kabelblende sowie einem mechanischen Schalter am Gehäuse.

Farbe

Verfügbare Farben: weiß, silber, chrom und schwarz. Bei einer Bestellung von mind. 100 Stück in einer Farbe ist ebenfalls eine Farbe aus der RAL-Farbpalette sowie folgende Sonderfarben möglich: Bronze und Gold.

Verfügbare Leistungen

120, 200, 300, 400, 600, 800, 1000 W.

Technische Daten:

- Stromversorgung:** 230 V / 50 Hz
- Heizelement:** Terma Split I
- Geräteschutzklasse:** Klasse I
- Heizkörperanschluss:** G 1/2"
- Gehäuseschutzstufe [IP]:** IPx4: Ausführung MS (Schraubklemme); IPx5: Ausführung mit Kabel

Konfigurationstabelle:

Beispiel Bestellcode: **WE** **KT4** **KTX 4** **T** **CRO** **W**

Modellcode Farbcode Kabeltypcode
Verpackungscode

Codeelemente sind blau markiert.

Modell	Leistung [W]	Verpackung	Farben	Kabeltyp
WE KT4 KTX 4	- ohne Heizelement	K Karton	916 Weiß	W Gerades Kabel mit Stecker
			SMA Silber	P Gerades Kabel ohne Stecker
			CRO Chrom	U Spiralkabel mit Stecker
			905 Schwarz	S Ohne Kabel (mit Schraubverbindung und Kabelblende)

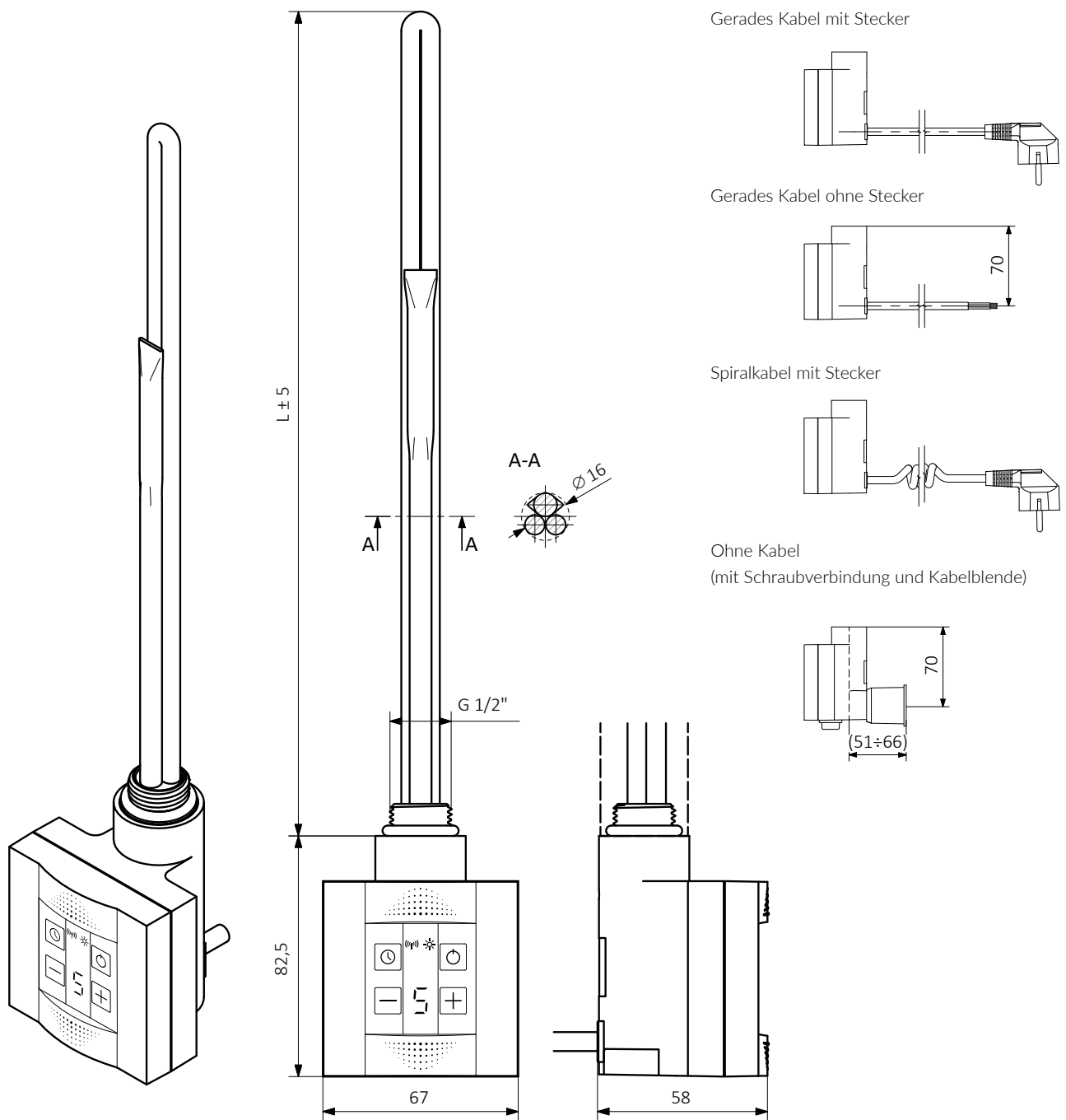

L [mm]	325	285	310	345	375	485	575
Leistung [W]	120	200	300	400	600	800	1000

Funktionen und Eigenschaften:

Funktionalität

Die volle Funktionalität der Heizpatrone ist über die Steuerungs-App BLUE-Line verfügbar. Dank ihr können sowohl die Heizkörpertemperatur (30-60°C) als auch die Raumtemperatur* (15-30°C) kontrolliert werden oder eine beliebige Anzahl Programme für einen 7-Tagesplan für den Betrieb des Gerätes programmiert werden. Außerdem steht eine erweiterte Timerfunktion zur Verfügung. Die Tasten am Gehäuse ermöglichen eine einfache Einstellung der Arbeitstemperatur und eine einfache Aktivierung der Timerfunktion (bis 4 Stunden). Das Gerät zeigt das aktuell eingestellte Temperaturniveau und den Status von Heiz- und Ruhephase an. Die Heizpatrone ist für die Verbindung mit dem Terma-Split-System konzipiert und bietet die Möglichkeit der Verbindung von Heizelement und Steuerung. Informationen über das Heizelement Terma-Split erhalten Sie auf der Seite 608. Die KTX 4 besitzt außerdem einen Echtzeit-Zähler für die tatsächliche Heizzeit. Dieser kann

für eine bessere Kontrolle der Energiemenge verwendet werden.

*betrifft nicht die MS Version

Timer

Die verbesserte Timer-Funktion schaltet die Heizpatrone automatisch nach 1, 2, 3 oder 4 Stunden ab.

Fernsteuerung

Die Heizpatrone bietet die Möglichkeit für eine Bluetooth-Kommunikation mit einer Steuerungs-App, welche die Heizpatrone um weitere Funktionen erweitert. Die Steuerungs-App kann kostenlos über den Play-Store oder Apple-Store heruntergeladen werden.

Intelligente Gebäudesysteme

Im Falle eines Stromausfalls speichert die Heizpatrone die aktuellen Einstellungen (Festeinstellung). Dies ermöglicht die Zusammenarbeit mit externen Timern und intelligenten Gebäudesystemen.

Sicherheit

Die Heizpatrone ist mit einem Frostschutz (ANTI-FREEZE) ausgestattet. Sie besitzt außerdem einen doppelten Schutz gegen Überhitzung. Anzeige von Betriebsstörungen.

Design

Gut lesbare, einstellige LED-Anzeige in blau. Die Steuerung ist ebenfalls erhältlich in einer Version mit einer Anschlussklemme und einer Kabelblende sowie einem mechanischen Schalter am Gehäuse.

Farbe

Verfügbare Farben: weiß, silber, chrom und schwarz. Bei einer Bestellung von mind. 100 Stück in einer Farbe ist ebenfalls eine Farbe aus der RAL-Farbpalette sowie folgende Sonderfarben möglich: Bronze und Gold.

Verfügbare Leistungen

120, 200, 300, 400, 600, 800, 1000 W

Technische Daten:

Stromversorgung:	230 V / 50 Hz
Heizelement:	Terma Split I
Geräteschutzklasse:	Klasse I
Heizkörperanschluss:	G 1/2"
Gehäuseschutzstufe [IP]:	IPx4: Ausführung MS (Schraubklemme); IPx5: Ausführung mit Kabel

Konfigurationstabelle:

Beispiel Bestellcode: **WE**^{Farbcode}**K4B**^{Modellcode}**T**^{Verpackungscode}**CRO**^{Kabeltypcode}**W**

Codeelemente sind blau markiert.

Modell	Leistung [W]	Verpackung	Farben	Kabeltyp
WE K4B KTX 4	- ohne Heizelement	K Karton	916 Weiß	W Gerades Kabel mit Stecker
			SMA Silber	P Gerades Kabel ohne Stecker
			CRO Chrom	U Spiralkabel mit Stecker
			905 Schwarz	S Ohne Kabel (mit Schraubverbindung und Kabelblende)

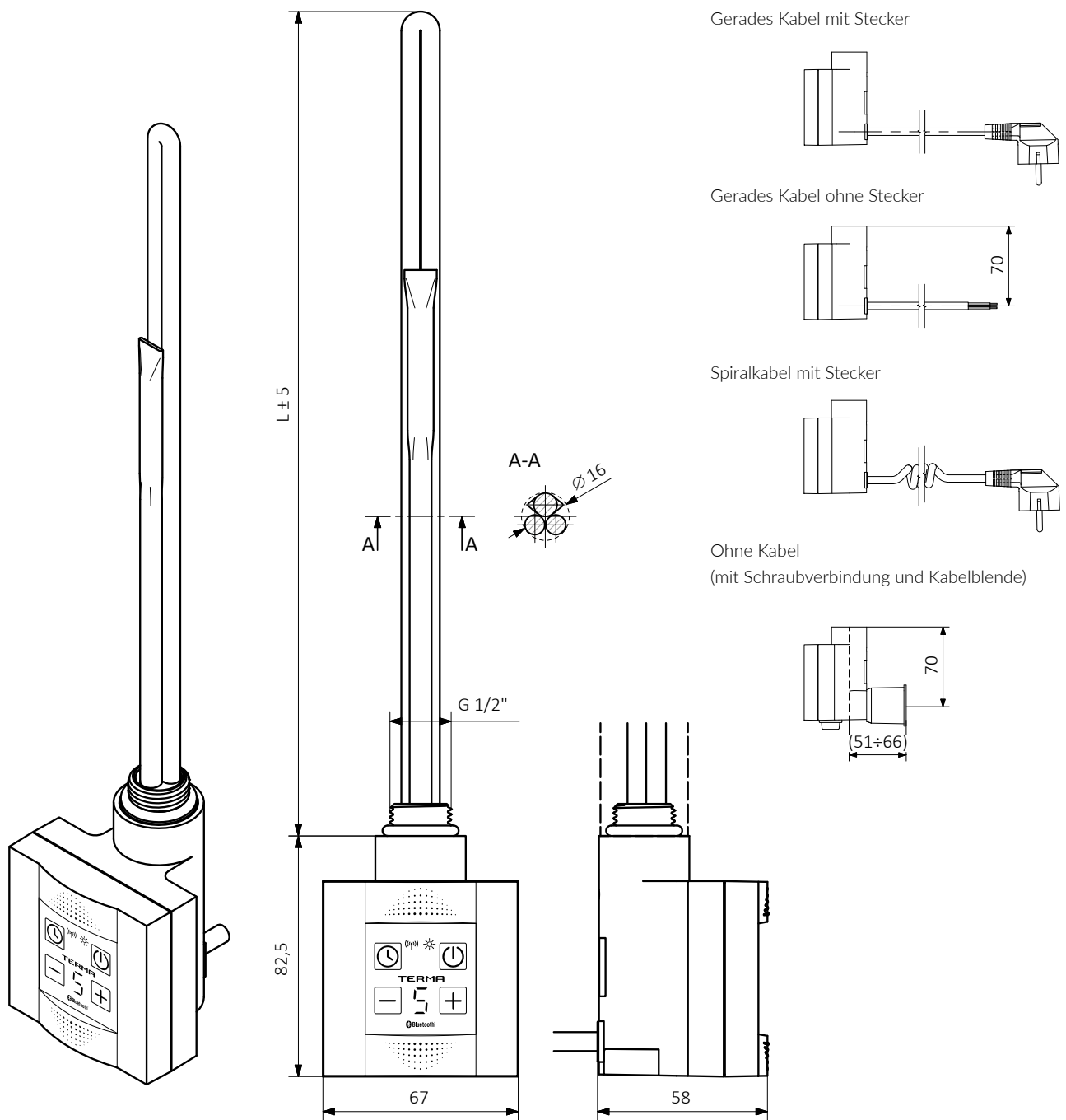

L [mm]	325	285	310	345	375	485	575
Leistung [W]	120	200	300	400	600	800	1000

Funktionen und Eigenschaften:

Funktionalität

Die Heizpatrone bietet die Möglichkeit zur Einstellung der Heiztemperatur im Bereich von 30°C bis 60°C in Schritten von 1°C. Das Gerät zeigt das aktuelle Temperaturniveau sowie den Status von Heiz- und Ruhezeit an. Das Interface der Heizpatrone ermöglicht eine einfache Programmierung und Bedienung. Die Heizpatrone ist für die Verbindung mit dem Terma-Split-System konzipiert und bietet die Möglichkeit der Verbindung von Heizelement und Steuerung. Informationen über das Heizelement Terma-Split finden Sie auf Seite 602.

Timer-Funktion

Der 24-Stunden-Timer ermöglicht die Programmierung von 4 Zeiträumen, in denen die Heizpatrone eine eingestellte Temperatur hält oder ausgeschaltet ist.

Trocken-Funktion

Eine Funktion zur Regelung der Temperatur und Trocknungszeit, nach der die Heizpatrone in ihren vorherigen Zustand zurückkehrt.

Intelligente Gebäudesysteme

Im Falle eines Stromausfalls speichert die Heizpatrone die aktuellen Einstellungen. Dies ermöglicht die Zusammenarbeit mit externen Timern und intelligenten Gebäudesystemen.

Sicherheit

Die Heizpatrone ist mit einem Frostschutz (ANTIFREEZE) sowie einem doppelten Schutz gegen Überhitzung ausgestattet. Anzeige von Betriebsstörungen. Sie besitzt außerdem einen aktiven Schutz gegen die Benutzung in trockenen Heizkörpern.

Design

Gut lesbare LED-Anzeige mit Uhrzeit. Die Steuerung ist ebenfalls erhältlich in einer Version mit einer Anschlussklemme und einer Kabelblende sowie einem mechanischen Schalter am Gehäuse.

Farben

Verfügbare Farben: weiß, silber, chrom und schwarz. Bei einer Bestellung von mind. 100 Stück in einer Farbe ist ebenfalls eine Farbe aus der RAL-Farbpalette sowie folgende Sonderfarben möglich: Bronze und gold.

Verfügbare Leistungen

120, 200, 300, 400, 600, 800, 1000 W

Technische Daten:

- Stromversorgung:** 230 V / 50 Hz
- Heizelement:** Terma Split I
- Geräteschutzklasse:** Klasse I
- Heizkörperanschluss:** G 1/2"
- Gehäuseschutzstufe [IP]:** IPx4: Ausführung MS (Schraubklemme); IPx5: Ausführung mit Kabel

Konfigurationstabelle:

Beispiel Bestellcode: **WE** **KT3** **T** **SMA** **W**

Modellcode Farbcode Kabeltypcode
Verpackungscode

Codeelemente sind blau markiert.

Modell	Leistung [W]	Verpackung	Farben	Kabeltyp
WE KT3 KTX 3	- ohne Heizelement	K Karton	916 Weiß	W Gerades Kabel mit Stecker
			SMA Silber	P Gerades Kabel ohne Stecker
			CRO Chrom	U Spiralkabel mit Stecker
			905 Schwarz	S Ohne Kabel (mit Schraubverbindung und Kabelblende)

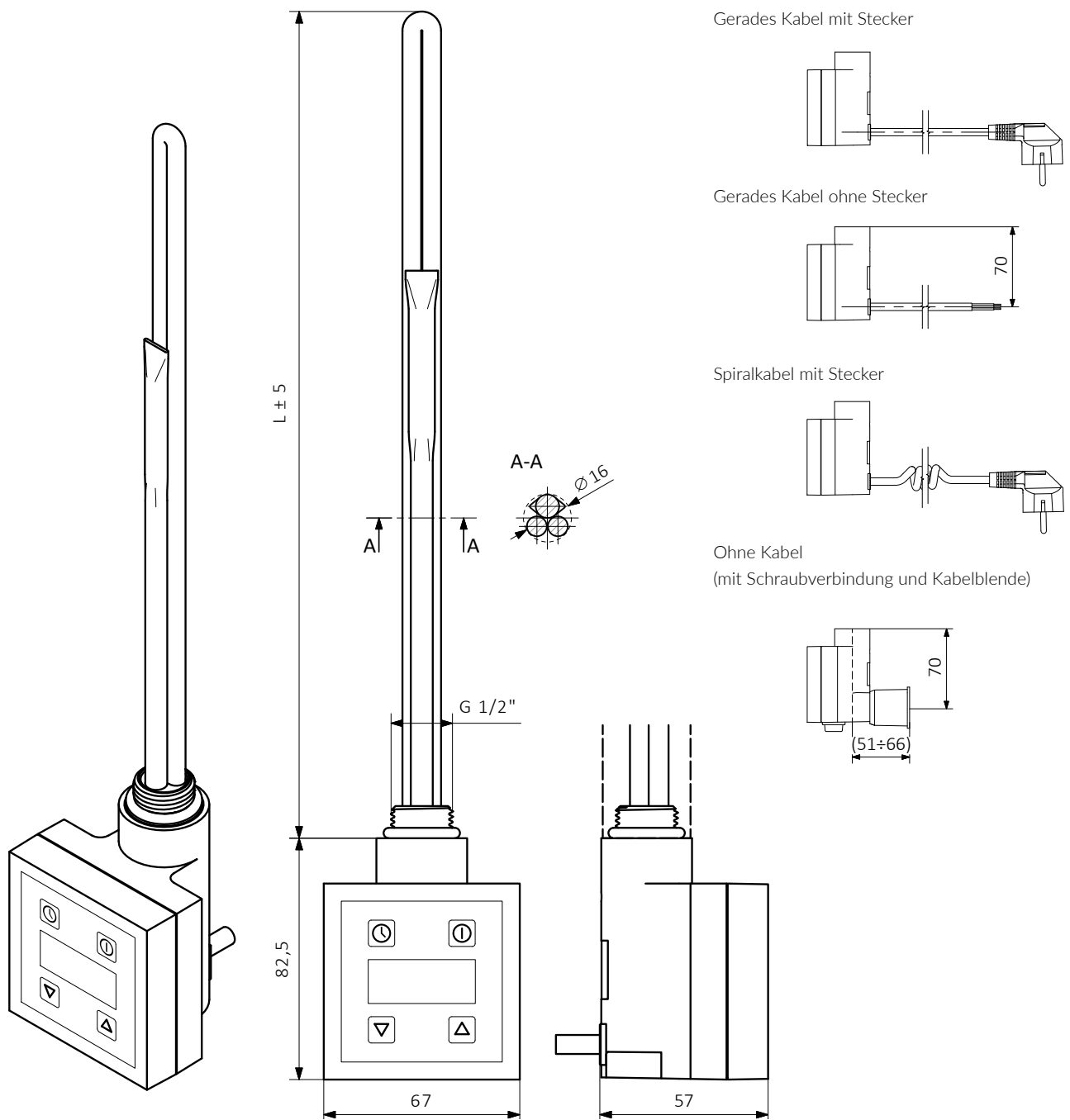

L [mm]	325	285	310	345	375	485	575
Leistung [W]	120	200	300	400	600	800	1000

Funktionen und Eigenschaften:

Funktionalität

Die Heizpatrone bietet 5 unterschiedliche Heiztemperatur-Einstellungen im Bereich von 30°C bis 60°C. Ein elektronischer Temperatursensor sorgt für eine präzise Regelung. Das Gerät zeigt das aktuell eingestellte Temperaturniveau an. Die Heizpatrone ist für die Verbindung mit dem Terma-Split-System konzipiert und bietet die Möglichkeit der Verbindung von Heizelement und Steuerung. Informationen über das Heizelement Terma-Split finden Sie auf Seite 602.

Timer

Bei der Timer-Funktion hält das Gerät den aktuell eingestellten Zustand für die nächsten 2 Stunden und schaltet danach in den gegenteiligen Zustand. Verwenden Sie diese Funktion

der Heizpatrone zum Heizen, dann heizt das Gerät in der gewählten Temperaturstufe für weitere 2 Stunden und schaltet sich danach ab. Ist die Heizpatrone bei Aktivierung der Timer-Funktion ausgeschaltet, dann schaltet sie sich nach Ablauf der 2 Stunden ein.

Intelligente Gebäudesysteme

Im Falle eines Stromausfalls speichert die Heizpatrone die aktuellen Einstellungen (Festeinstellung). Dies ermöglicht die Zusammenarbeit mit externen Timern und intelligenten Gebäudesystemen.

Sicherheit

Die Heizpatrone ist mit einem Frostschutz (ANTIFREEZE) sowie einem doppelten Schutz gegen Überhitzung ausgestattet. Anzeige von Betriebsstörungen.

Design

Einfach zu bedienendes Interface. Die Steuerung ist ebenfalls erhältlich in einer Version mit einer Anschlussklemme und einer Kabelblende sowie einem mechanischen Schalter am Gehäuse.

Farben

Verfügbare Farben: weiß, silber, chrom und schwarz. Bei einer Bestellung von mind. 100 Stück in einer Farbe ist ebenfalls eine Farbe aus der RAL-Farbpalette sowie folgende Sonderfarben möglich: Bronze und Gold.

Verfügbare Leistungen

120, 200, 300, 400, 600, 800, 1000 W

Technische Daten:

- Stromversorgung:** 230 V / 50 Hz
- Heizelement:** Terma Split I
- Geräteschutzklasse:** Klasse I
- Heizkörperanschluss:** G 1/2"
- Gehäuseschutzstufe [IP]:** IPx4: Ausführung MS (Schraubklemme); IPx5: Ausführung mit Kabel

Konfigurationstabelle:

Beispiel Bestellcode: **WE** **KT2** **T** **SMA** **W**

Modellcode Farbcode Kabeltypcode Verpackungscode

Codeelemente sind blau markiert.

Modell	Leistung [W]	Verpackung	Farben	Kabeltyp
WE KT2 KTX 2	- ohne Heizelement	K Karton	916 Weiß	W Gerades Kabel mit Stecker
			SMA Silber	P Gerades Kabel ohne Stecker
			CRO Chrom	U Spiralkabel mit Stecker
			905 Schwarz	S Ohne Kabel (mit Schraubverbindung und Kabelblende)

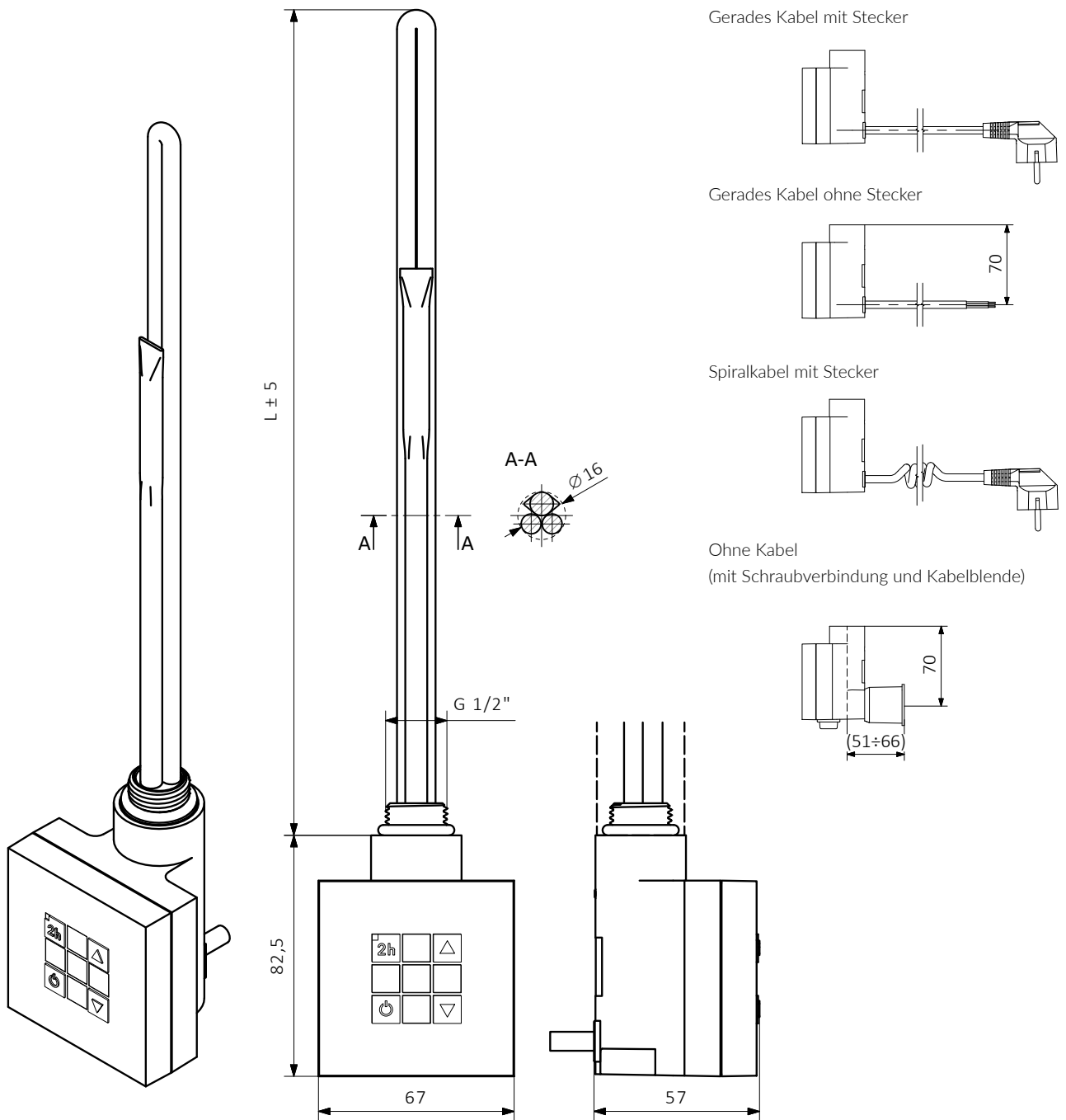

L [mm]	325	285	310	345	375	485	575
Leistung [W]	120	200	300	400	600	800	1000

Funktionen und Eigenschaften:

Funktionalität

Die Heizpatrone bietet zwei Einstellungen: 50% und 100% der nominalen Leistung. Die Heizpatrone ist für die Verbindung mit dem Terma-Split-System konzipiert und bietet die Möglichkeit der Verbindung von Heizelement und Steuerung. Informationen über das Heizelement Terma-Split finden Sie auf Seite 602.

Intelligente Gebäudesysteme

Im Falle eines Stromausfalls speichert die Heizpatrone die aktuellen Einstellungen (Festeinstellung). Dies ermöglicht die Zusammenarbeit mit externen Timern und intelligenten Gebäudesystemen.

Sicherheit

Die Heizpatrone ist mit einem Frostschutz (ANTIFREEZE) sowie einem doppelten Schutz gegen Überhitzung ausgestattet. Anzeige von Betriebsstörungen.

Design

Große, ergonomische Tasten ermöglichen eine einfache Bedienung. Die Steuerung ist ebenfalls erhältlich in einer Version mit einer Anschlussklemme und einer Kabelblende sowie einem mechanischen Schalter am Gehäuse.

Farben

Verfügbare Farben: weiß, silber, chrom und schwarz. Bei einer Bestellung von mind. 100 Stück in einer Farbe ist ebenfalls eine Farbe aus der RAL-Farbpalette sowie folgende Sonderfarben möglich: Bronze und Gold

Verfügbare Leistungen

120, 200, 300, 400, 600, 800, 1000 W

Technische Daten:

- Stromversorgung: 230 V / 50 Hz
- Heizelement: Terma Split I
- Geräteschutzklasse: Klasse I
- Heizkörperanschluss: G 1/2"
- Gehäuseschutzstufe [IP]: IPx4

Konfigurationstabelle:

Beispiel Bestellcode: **WE** **KT1** **T** **SMA** **W**

Modellcode Farbcode Kabeltypcode
Verpackungscode

Codeelemente sind blau markiert.

Modell	Leistung [W]	Verpackung	Farben	Kabeltyp
WE KT1 KTX 1	- ohne Heizelement	K Karton	916 Weiß	W Gerades Kabel mit Stecker
			SMA Silber	P Gerades Kabel ohne Stecker
			CRO Chrom	U Spiralkabel mit Stecker
			905 Schwarz	S Ohne Kabel (mit Schraubverbindung und Kabelblende)

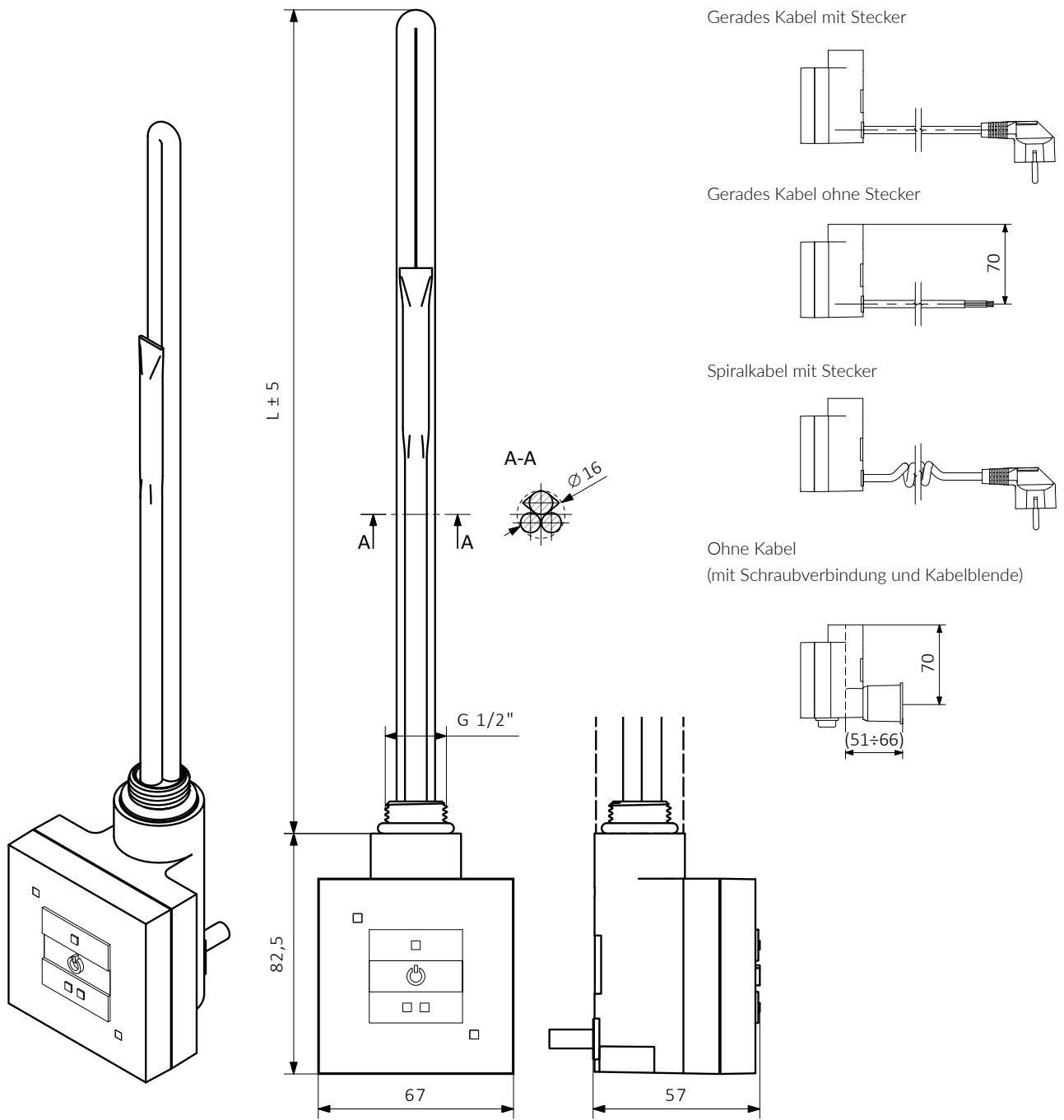

L [mm]	325	285	310	345	375	485	575
Leistung [W]	120	200	300	400	600	800	1000

Funktionen und Eigenschaften:

Funktionalität

Die Heizpatrone bietet 5 unterschiedliche Heiztemperatur-Einstellungen im Bereich von 30°C bis 60°C. Ein elektronischer Temperatursensor sorgt für eine präzise Regelung. Das Gerät zeigt das eingestellte und das aktuelle Temperaturniveau. Sie zeichnet sich durch einen sehr geringen Stromverbrauch im Standby-Betrieb aus.

Trocken-Funktion

Die Funktion ermöglicht die Verwendung einer beliebigen Temperaturstufe für 2 Stunden. Danach schaltet die Heizpatrone in ihren vorherigen Zustand zurück.

Intelligente Gebäudesysteme

Im Falle eines Stromausfalls speichert die Heizpatrone die aktuellen Einstellungen (Festeinstellung). Dies ermöglicht die Zusammenarbeit mit externen Timern und intelligenten Gebäudesystemen.

Sicherheit

Die Heizpatrone ist mit einem Frostschutz (ANTIFREEZE) sowie einem doppelten Schutz gegen Überhitzung ausgestattet. Anzeige von Betriebsstörungen. Sie besitzt außerdem einen aktiven Schutz gegen die Benutzung in trockenen Heizkörpern.

Design

Es besteht die Auswahl zwischen einer Version mit Spiralkabel und Stecker, geradem Kabel mit Stecker sowie geradem Kabel ohne Stecker, dafür mit einer Kabelblende für das Netzkabel.

Farben

Verfügbare Farben: weiß, silber, chrom und schwarz. Bei einer Bestellung von mind. 100 Stück in einer Farbe ist ebenfalls eine Farbe aus der RAL-Farbpalette sowie folgende Sonderfarben möglich: Bronze und Gold.

Verfügbare Leistungen

120, 200, 300, 400, 600, 800, 1000, 1200 W

Technische Daten:

- Stromversorgung:** 230 V / 50 Hz
- Geräteschutzklasse:** Klasse I
- Heizkörperanschluss:** G 1/2"
- Gehäuseschutzstufe [IP]:** IPx5

Konfigurationstabelle:

Beispiel Bestellcode: **WE**^{Leistungscode}**MAT**^{Farbcode}**04**^{Kabeltypcode}**T**^{Modellcode}**SMA**^{Verpackungscode}**W**

Codeelemente sind blau markiert.

Modell	Leistung [W]	Verpackung	Farben	Kabeltyp
WE MOA MOA	01 120	F glatte Folie	916 Weiß	W Gerades Kabel mit Stecker
MAT MOA + T-Stück	02 200	T Tube (Rohr)	SMA Silber	M Gerades Kabel ohne Stecker mit Kabelblende
	03 300		CRO Chrom	U Spiralkabel mit Stecker
	04 400		905 Schwarz	
	06 600			
	08 800			
	10 1000			
	12 1200			

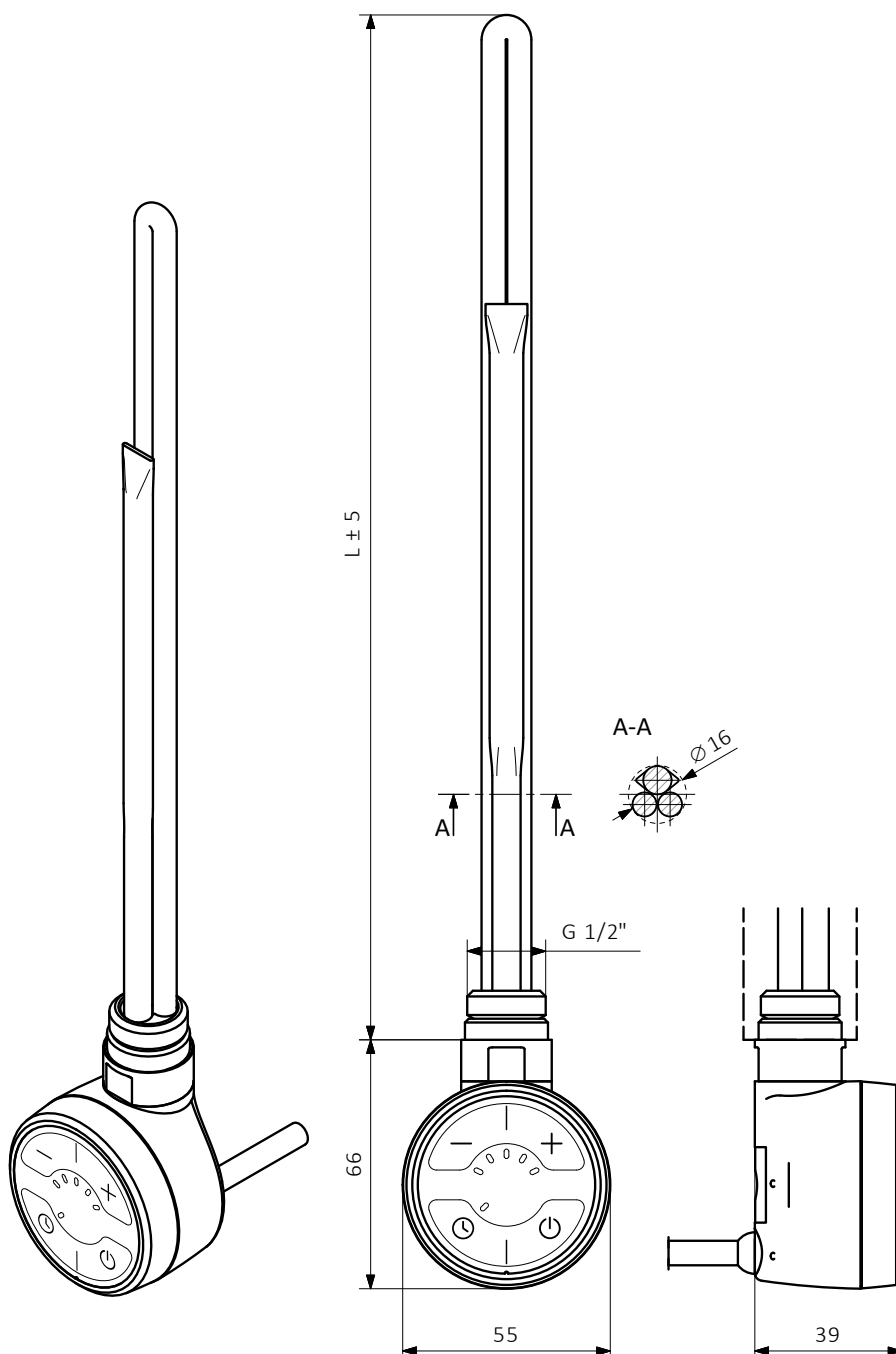

Gerades Kabel ohne Stecker mit
Kabelblende

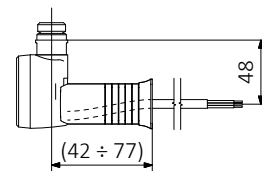

Gerades Kabel mit Stecker

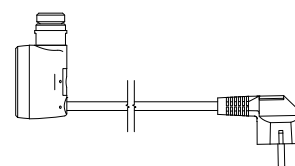

Spiralkabel mit Stecker

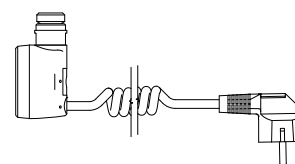

L [mm]	315	275	300	335	365	475	565	660
Leistung [W]	120	200	300	400	600	800	1000	1200

Funktionen und Eigenschaften:

Funktionalität

Die Heizpatrone bietet 5 unterschiedliche Heiztemperatur-Einstellungen im Bereich von 30°C bis 60°C. Ein elektronischer Temperatursensor sorgt für eine präzise Regelung. Das Gerät zeigt das eingestellte und das aktuelle Temperaturniveau. Sie zeichnet sich durch einen sehr geringen Stromverbrauch im Standby-Betrieb aus.

Trocken-Funktion

Die Funktion ermöglicht die Verwendung einer beliebigen Temperaturstufe für 2 Stunden. Danach schaltet die Heizpatrone in ihren vorherigen Zustand zurück.

Fernsteuerung

Die Heizpatrone bietet die Möglichkeit für eine IR-Kommunikation mit einer externen Fernsteuerung, welche die Heizpatrone um

weitere Funktionen erweitert. IR-Fernsteuerungen – Modelle TTIR und DTIR finden Sie auf Seite 632 und 634.

Intelligente Gebäudesysteme

Im Falle eines Stromausfalls speichert die Heizpatrone die aktuellen Einstellungen (Feststellung). Dies ermöglicht die Zusammenarbeit mit externen Timern und intelligenten Gebäudesystemen.

Sicherheit

Die Heizpatrone ist mit einem doppelten Schutz gegen Überhitzung ausgestattet und verfügt über einen aktiven Schutz vor Benutzung in einem trockenen Heizkörper. Das Antifreeze-Programm verhindert ein Einfrieren des Heizmediums im Heizkörper. Die Heizpatrone zeigt die aktuelle Betriebsart und mögliche Fehlermeldungen an.

Design

Es besteht die Auswahl zwischen einer Version mit Spiralkabel und Stecker, geradem Kabel mit Stecker sowie geradem Kabel ohne Stecker, dafür mit einer Kabelblende für das Netzkabel.

Farben

Verfügbare Gehäusefarben: weiß, silber, chrom und schwarz. Bei einer Bestellung von mind. 100 Stück in einer Farbe ist ebenfalls eine Farbe aus der RAL-Farbpalette sowie folgende Sonderfarben möglich: Bronze und Gold.

Verfügbare Leistungen

120, 200, 300, 400, 600, 800, 1000, 1200 W

Technische Daten:

- Stromversorgung:** 230 V / 50 Hz
- Geräteschutzklasse:** Klasse I
- Heizkörperanschluss:** G 1/2"
- Gehäuseschutzstufe [IP]:** IPx5

Konfigurationstabelle:

Beispiel Bestellcode: **WE** MOR 04 T SMA W

Leistungscod Farbcode Kabeltypcode
Modellcode Verpackungscod

Codeelemente sind blau markiert.

Modell	Leistung [W]	Verpackung	Farben	Kabeltyp
WE MOR MOA IR	01 120	F glatte Folie	916 Weiß	W Gerades Kabel mit Stecker
MRT MOA IR + T-Stück	02 200	T Tube (Rohr)	SMA Silber	M Gerades Kabel ohne Stecker mit Kabelblende
	03 300		CRO Chrom	U Spiralkabel mit Stecker
	04 400		905 Schwarz	
	06 600			
	08 800			
	10 1000			
	12 1200			

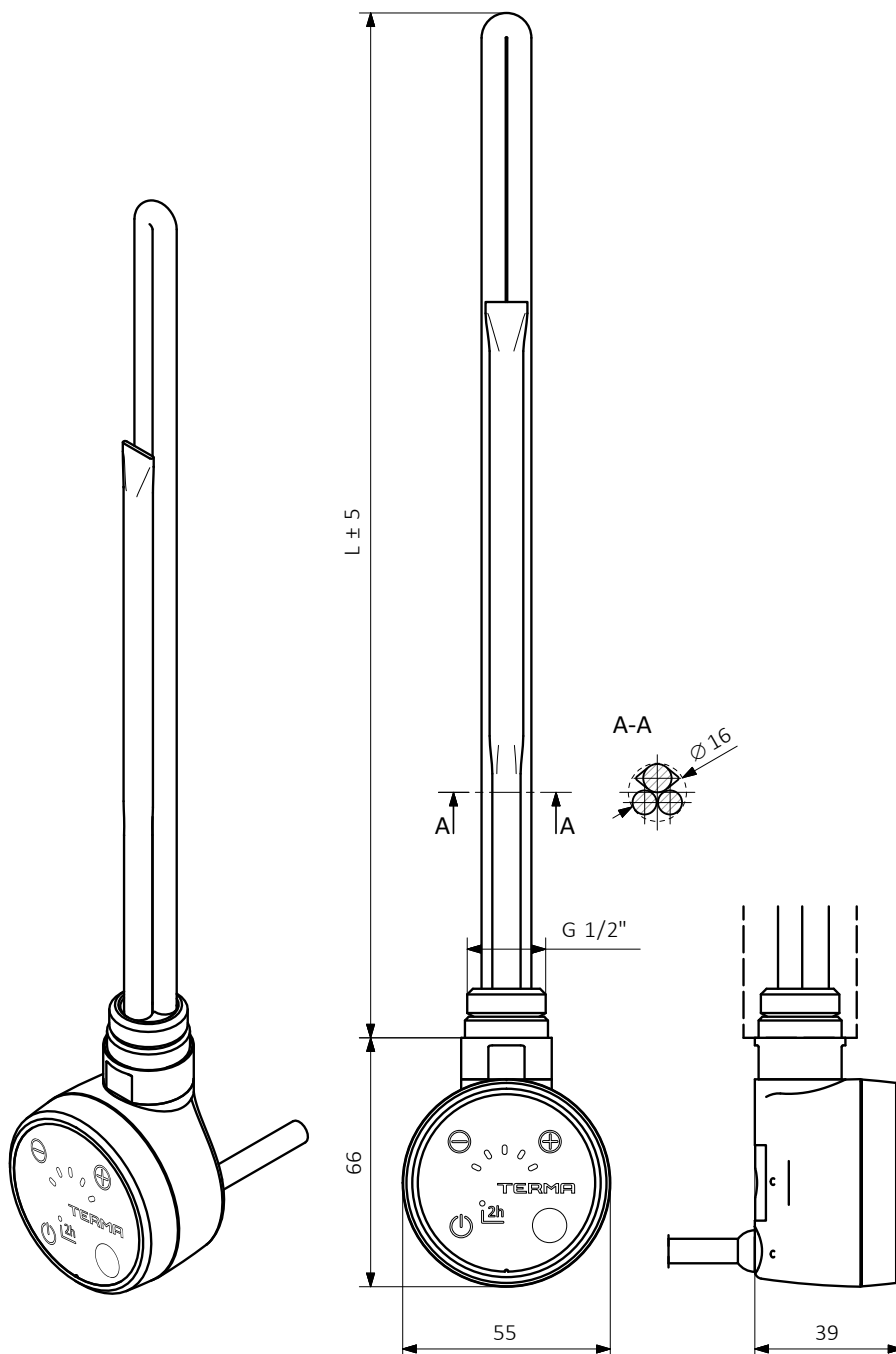

Gerades Kabel ohne Stecker mit
Kabelblende

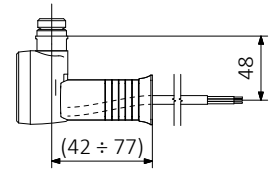

Gerades Kabel mit Stecker

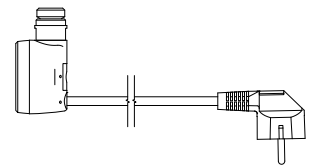

Spiralkabel mit Stecker

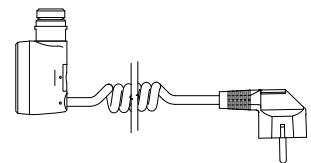

L [mm]	315	275	300	335	365	475	565	660
Leistung [W]	120	200	300	400	600	800	1000	1200

Funktionen und Eigenschaften:

Funktionalität

Die volle Funktionalität der Heizpatrone ist über die Steuerungs-App BLUE-Line verfügbar. Dank ihr können sowohl die Heizkörpertemperatur (30-60°C) als auch die Raumtemperatur (15-30°C) kontrolliert werden oder eine beliebige Anzahl Programme für einen 7-Tagesplan für den Betrieb des Gerätes programmiert werden. Außerdem steht eine erweiterte Timerfunktion zur Verfügung. Die Tasten am Gehäuse ermöglichen eine einfache Einstellung der Arbeitstemperatur und eine einfache Aktivierung der Timerfunktion (bis 2 Stunden). Das Gerät zeigt das eingestellte und das aktuelle Temperaturniveau. Sie zeichnet sich durch einen sehr geringen Stromverbrauch im Standby-Betrieb aus.

Trocken-Funktion

Die Funktion ermöglicht die Verwendung einer beliebigen Temperaturstufe für 2 Stunden.

Den. Danach schaltet die Heizpatrone in ihren vorherigen Zustand zurück.

Fernsteuerung

Die Heizpatrone bietet die Möglichkeit für eine Bluetooth-Kommunikation mit einer Steuerungs-App, welche die Heizpatrone um weitere Funktionen erweitert. Die Steuerungs-App kann kostenlos über den Play-Store oder Apple-Store heruntergeladen werden.

Intelligente Gebäudesysteme

Im Falle eines Stromausfalls speichert die Heizpatrone die aktuellen Einstellungen (Festeinstellung). Dies ermöglicht die Zusammenarbeit mit externen Timern und intelligenten Gebäudesystemen.

Sicherheit

Die Heizpatrone ist mit einem doppelten Schutz gegen Überhitzung ausgestattet und verfügt über einen aktiven Schutz vor Benut-

zung in einem trockenen Heizkörper. Das Antifreeze-Programm verhindert ein Einfrieren des Heizmediums im Heizkörper. Die Heizpatrone zeigt die aktuelle Betriebsart und mögliche Fehlermeldungen an.

Design

Es besteht die Auswahl zwischen einer Version mit Spiralkabel und Stecker, geradem Kabel mit Stecker sowie geradem Kabel ohne Stecker, dafür mit einer Kabelblende für das Netzkabel.

Farben

Verfügbare Gehäusefarben: weiß, silber, chrom und schwarz. Bei einer Bestellung von mind. 100 Stück in einer Farbe ist ebenfalls eine Farbe aus der RAL-Farbpalette sowie folgende Sonderfarben möglich: Bronze und Gold.

Verfügbare Leistungen

120, 200, 300, 400, 600, 800, 1000, 1200 W

Technische Daten:

- Stromversorgung: 230 V / 50 Hz
- Geräteschutzklasse: Klasse I
- Heizkörperanschluss: G 1/2"
- Gehäuseschutzstufe [IP]: IPx5

Konfigurationstabelle:

Beispiel Bestellcode: **WE** ^{Leistungscode} **MOB** ^{Farbcode} **04** ^{Kabeltypcode} **T** ^{Modellcode} **SMA** ^{Verpackungscode} **W**

Codeelemente sind blau markiert.

Modell	Leistung [W]	Verpackung	Farben	Kabeltyp
WE MOB MOA Blue	01 120	F glatte Folie	916 Weiß	W Gerades Kabel mit Stecker
MBT MOA Blue + T-Stück	02 200	T Tube (Rohr)	SMA Silber	M Gerades Kabel ohne Stecker mit Kabelblende
	03 300		CRO Chrom	U Spiralkabel mit Stecker
	04 400		905 Schwarz	
	06 600			
	08 800			
	10 1000			
	12 1200			

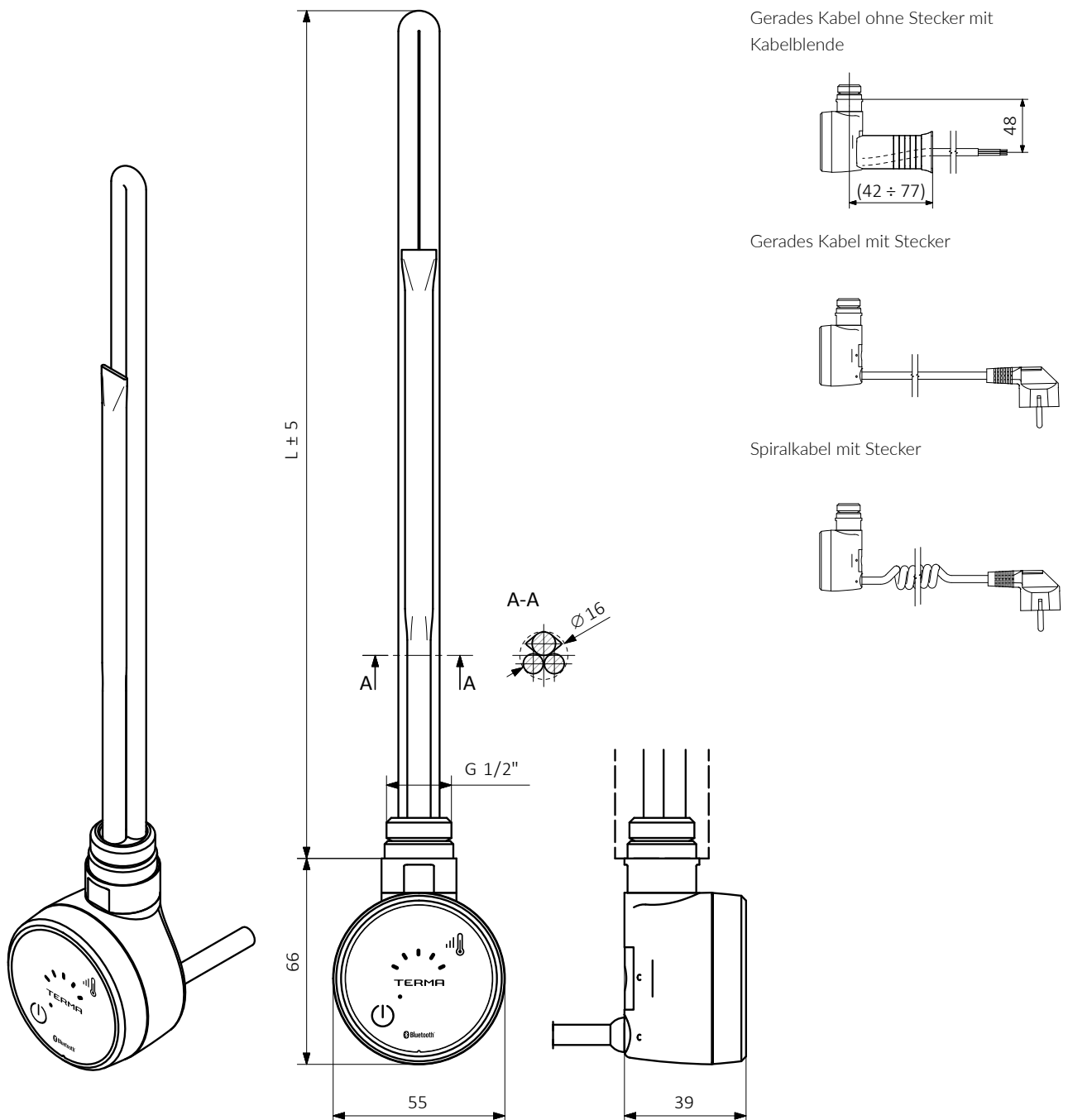

L [mm]	315	275	300	335	365	475	565	660
Leistung [W]	120	200	300	400	600	800	1000	1200

Funktionen und Eigenschaften:

Funktionalität

Praktische Heizpatrone mit einer standardmäßig eingestellten Heiztemperatur von konstant 48°C. Es besteht die Möglichkeit andere Temperaturniveaus zu programmieren. Die Heizpatrone hat einen sehr geringen Stromverbrauch im Standby-Modus.

Timer

Eine erweiterte Timer-Funktion schaltet das Gerät nach 1, 2, 3, 4 oder 5 Stunden automatisch ab.

Intelligente Gebäudesysteme

Im Falle eines Stromausfalls speichert die Heizpatrone die aktuellen Einstellungen (Festeinstellung). Dies ermöglicht die Zusammenarbeit mit externen Timern und intelligenten Gebäudesystemen.

Sicherheit

Die Heizpatrone ist mit einem Frostschutz (ANTIFREEZE) sowie einem doppelten Schutz gegen Überhitzung ausgestattet. Anzeige von Betriebsstörungen. Sie besitzt außerdem einen aktiven Schutz gegen die Benutzung in trockenen Heizkörpern.

Design

Es besteht die Auswahl zwischen einer Version mit Spiralkabel und Stecker, geradem Kabel mit Stecker sowie geradem Kabel ohne Stecker, dafür mit einer Kabelblende für das Netzkabel.

Farben

Verfügbare Gehäusefarben: weiß, silber, chrom und schwarz. Bei einer Bestellung von mind. 100 Stück in einer Farbe ist ebenfalls eine Farbe aus der RAL-Farbpalette sowie folgende Sonderfarben möglich: Bronze und Gold.

Verfügbare Leistungen

120, 200, 300, 400, 600, 800, 1000, 1200 W

Technische Daten:

- Stromversorgung:** 230 V / 50 Hz
- Geräteschutzklasse:** Klasse I
- Heizkörperanschluss:** G 1/2"
- Gehäuseschutzstufe [IP]:** IPx5

Konfigurationstabelle:

Beispiel Bestellcode: **WE** **DRY** **04** **T** **SMA** **W**

Leistungscod
Farbcode
Kabeltypcode
Modellcode
Verpackungscod

Codeelemente sind blau markiert.

Modell	Leistung [W]	Verpackung	Farben	Kabeltyp
WE DRY DRY	01 120	F glatte Folie	916 Weiß	W Gerades Kabel mit Stecker
DYT DRY + T-Stück	02 200		SMA Silber	M Gerades Kabel ohne Stecker mit Kabelblende
	03 300		CRO Chrom	U Spiralkabel mit Stecker
	04 400		905 Schwarz	
	06 600			
	08 800			
	10 1000			
	12 1200			

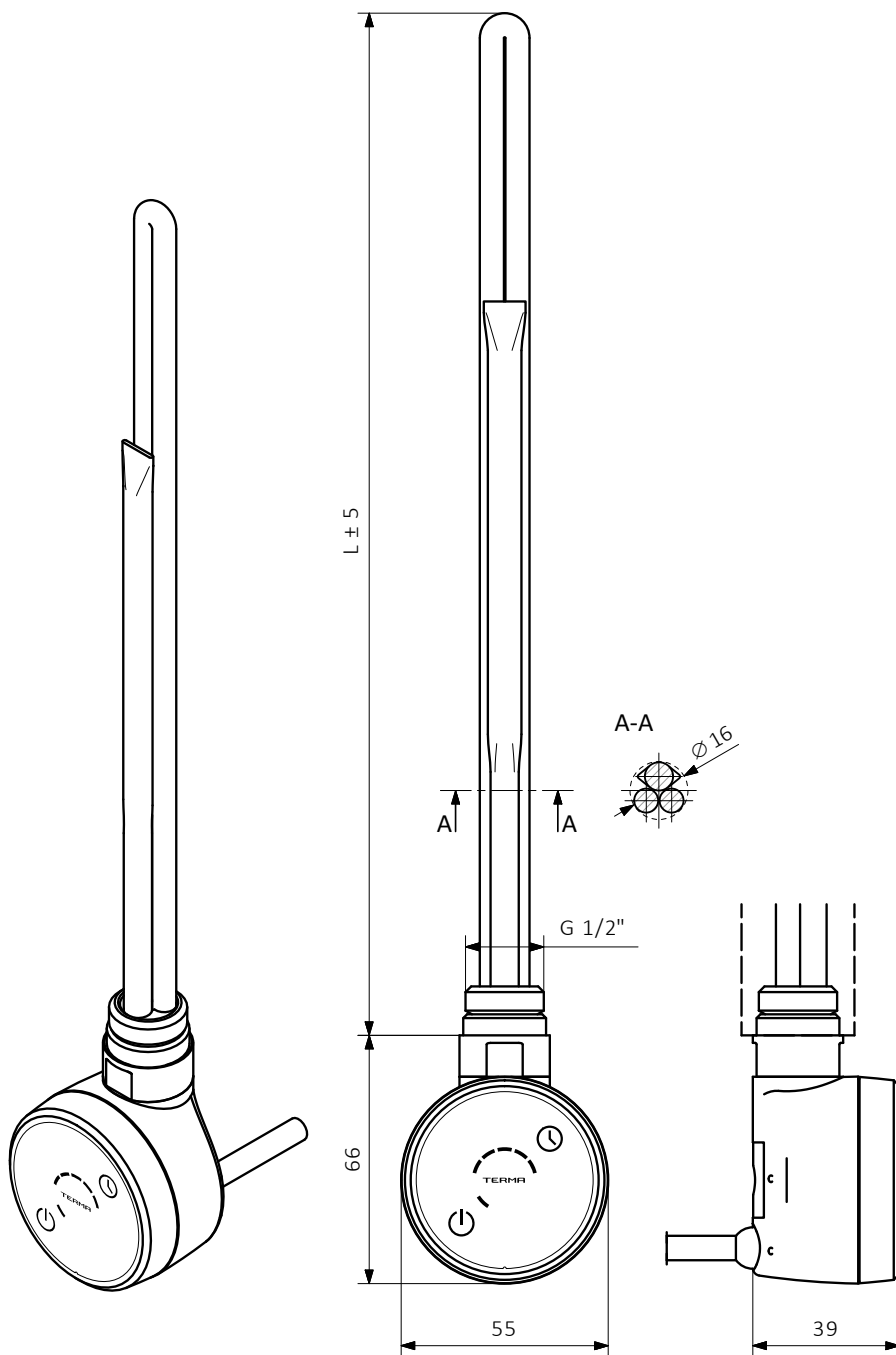

Gerades Kabel ohne Stecker mit
Kabelblende

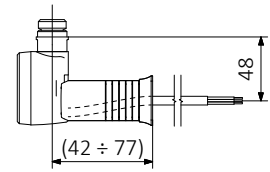

Gerades Kabel mit Stecker

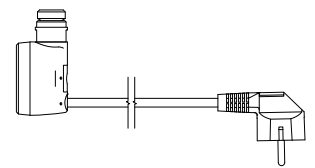

Spiralkabel mit Stecker

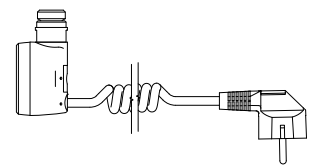

L [mm]	315	275	300	335	365	475	565	660
Leistung [W]	120	200	300	400	600	800	1000	1200

Funktionen und Eigenschaften:

Funktionalität

Die Heizpatrone bietet 5 unterschiedliche Heiztemperaturen im Bereich von 30°C bis 60°C. Ein elektronischer Temperatursensor sorgt für eine präzise Regelung. Das Gerät zeigt das eingestellte und das aktuelle Temperaturniveau.

Intelligente Gebäudesysteme

Im Falle eines Stromausfalls speichert die Heizpatrone die aktuellen Einstellungen (Festeinstellung). Dies ermöglicht die Zusammenarbeit mit externen Timern und intelligenten Gebäudesystemen.

Sicherheit

Die Heizpatrone ist mit einem Frostschutz (ANTIFREEZE) sowie einem doppelten Schutz gegen Überhitzung ausgestattet. Anzeige von Betriebsstörungen. Sie besitzt außerdem einen aktiven Schutz gegen die Benutzung in trockenen Heizkörpern.

Design

Es besteht die Auswahl zwischen einer Version mit Spiralkabel und Stecker, geradem Kabel mit Stecker sowie geradem Kabel ohne Stecker, dafür mit einer Kabelblende für das Netzkabel.

Farben

Verfügbare Farben: weiß, silber, chrom und schwarz. Bei einer Bestellung von mind. 100 Stück in einer Farbe ist ebenfalls eine Farbe aus der RAL-Farbpalette sowie folgende Sonderfarben möglich: Bronze und Gold.

Verfügbare Leistungen

120, 200, 300, 400, 600, 800, 1000, 1200 W

Technische Daten:

- Stromversorgung: 230 V / 50 Hz
- Geräteschutzklasse: Klasse I
- Heizkörperanschluss: G 1/2"
- Gehäuseschutzstufe [IP]: IPx4

Konfigurationstabelle:

Beispiel Bestellcode: **WE**MEG**04**T**SMA**W

Leistungscod Farbcode Kabeltypcode
Modellcode Verpackungscod

Codeelemente sind blau markiert.

Modell	Leistung [W]	Verpackung	Farben	Kabeltyp
WE MEG MEG	01 120	F glatte Folie	916 Weiß	W Gerades Kabel mit Stecker
MGT MEG + T-Stück	02 200	T Tube	SMA Silber	M Gerades Kabel ohne Stecker mit Kabelblende
	03 300		CRO Chrom	U Spiralkabel mit Stecker
	04 400		905 Schwarz	
	06 600			
	08 800			
	10 1000			
	12 1200			

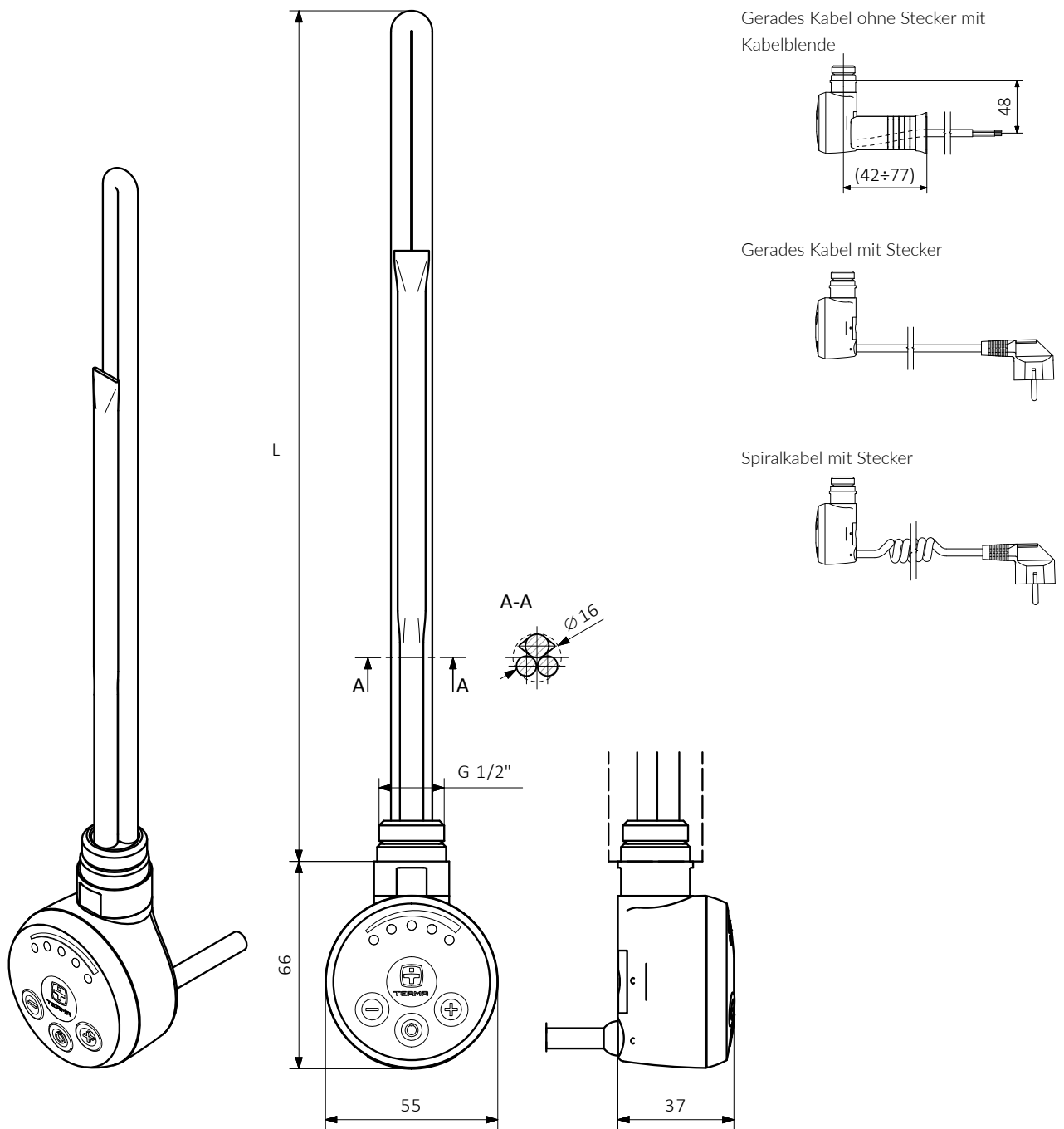

L [mm]	315	275	300	335	365	475	565	660
Leistung [W]	120	200	300	400	600	800	1000	1200

Funktionen und Eigenschaften:

Funktionalität

Die Heizpatrone ermöglicht die Auswahl zwischen 2 unterschiedlichen Temperaturebenen, bei gleichzeitiger Anzeige der aktuellen Einstellung: 50°C oder 65°C.

Intelligente Gebäudesysteme

Im Falle eines Stromausfalls speichert die Heizpatrone die aktuellen Einstellungen (Festeinstellung). Dies ermöglicht die Zusammenarbeit mit externen Timern und intelligenten Gebäudesystemen.

Sicherheit

Die Heizpatrone ist mit einem doppelten Schutz gegen Überhitzung ausgestattet.

Design

Das kleine Gehäuse und die universelle Form erinnern an einen Wassertropfen. Die Heizpatrone besitzt einen beweglichen Ring am Gehäuse um das Gerät einzuschalten und die Heiztemperatur einzustellen.

Farben

Verfügbare Farben: weiß, silber, chrom und schwarz.

Verfügbare Leistungen

120, 200, 300, 400, 600, 800, 1000, 1200 W.

Technische Daten:

- Stromversorgung: 230 V AC
- Geräteschutzklasse: Klasse I
- Heizkörperanschluss: G 1/2"
- Gehäuseschutzstufe [IP]: IPx5

Konfigurationstabelle:

Beispiel Bestellcode: **WE**^{Leistungscod}**R3G**^{Farbcode}**04**^{Modellcode}**T**^{Verpackungscod}**SMA**^{Kabeltypcode}**W**

Codeelemente sind blau markiert.

Modell	Leistung [W]	Verpackung	Farben	Kabeltyp
WE R3G REG 3	01 120	F glatte Folie	916 Weiß mit grauem Ring	W Gerades Kabel mit Stecker
R3T REG 3+ T-Stück	02 200	T Tube (Rohr)	SMA Silber mit grauem Ring	P Gerades Kabel ohne Stecker
	03 300		CRO Silber mit chromfarbigem Ring	U Spiralkabel mit Stecker
	04 400		905 Schwarz mit chromfarbigem Ring	
	06 600			
	08 800			
	10 1000			
	12 1200			

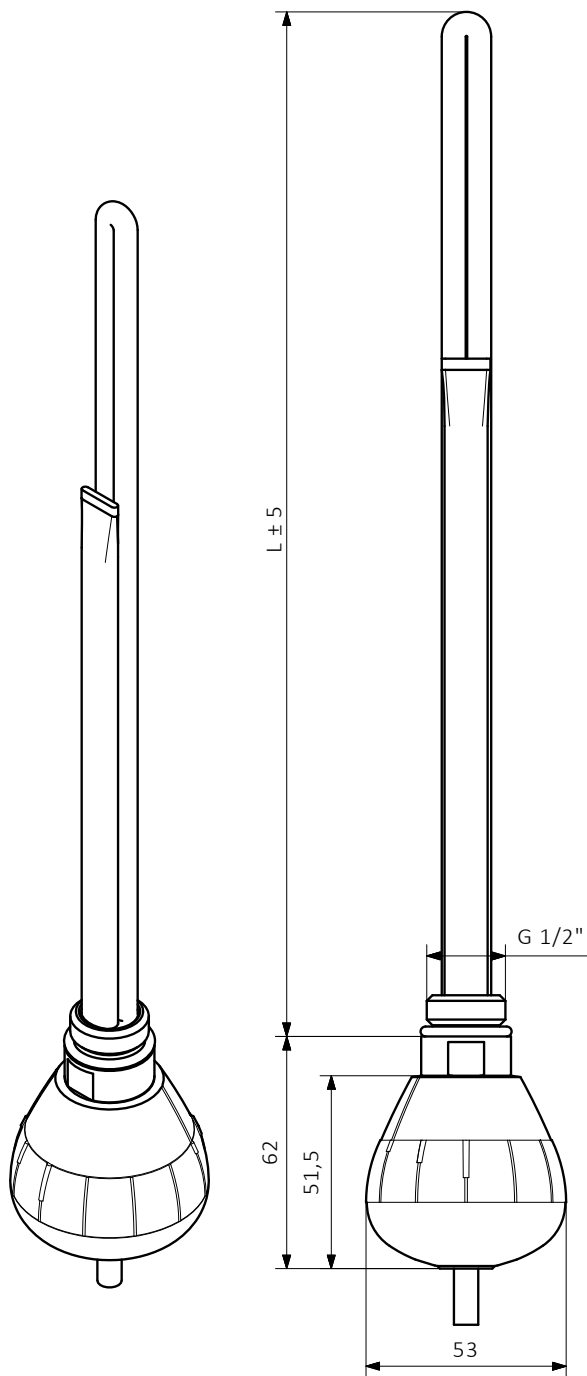

Gerades Kabel ohne Stecker



Gerades Kabel mit Stecker

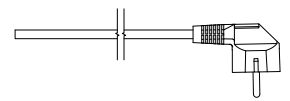

Spiralkabel mit Stecker

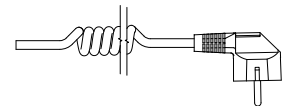

L [mm]	315	275	300	335	365	475	565	660
Leistung [W]	120	200	300	400	600	800	1000	1200

Funktionen und Eigenschaften:

Funktionalität

Die Heizpatrone hält eine gleichmäßige Temperatur von 65°C. Eine LED-Diode zeigt die Verbindung mit dem Stromnetz. Das Gerät verfügt über einen Bimetall-Temperatursensor.

Intelligente Gebäudesysteme.

Das Gerät kann mit externen Timern oder intelligenten Gebäudesystemen zusammenarbeiten.

Sicherheit

Die Heizpatrone ist mit einem doppelten Schutz gegen Überhitzung ausgestattet.

Design

Kleines, originelles, kugelförmiges Steuerungsgehäuse. Die Heizpatrone besitzt keinen Schalter am Gehäuse, ist jedoch in einer Version mit Schalter am Stecker verfügbar.

Farben

Verfügbare Farben: weiß, silber, chrom und schwarz.

Verfügbare Leistungen

120, 200, 300, 400, 600, 800, 1000, 1200 W

Technische Daten:

- Stromversorgung: 230 V AC
- Geräteschutzklasse: Klasse I
- Heizkörperanschluss: G 1/2"
- Gehäuseschutzstufe [IP]: IPx5

Konfigurationstabelle:

Beispiel Bestellcode: **WE**^{Leistungscod}**R2G**^{Farbcode}**04**^{Kabeltypcode}**T**^{Modellcode}**SMA**^{Verpackungscod}**W**

Codeelemente sind blau markiert.

Modell	Leistung [W]	Verpackung	Farbe	Kabeltyp
WE R2G REG 2	01 120	F glatte Folie	916 Weiß	P Gerades Kabel ohne Stecker
R2T REG 2 + T-Stück	02 200	T Tube (Rohr)	SMA Silber	W Gerades Kabel mit Stecker
	03 300		CRO Chrom	R Gerades Kabel mit Stecker und Schalter
	04 400		905 Schwarz	U Spiralkabel mit Stecker
	06 600			T Spiralkabel mit Stecker und Schalter
	08 800			
	10 1000			
	12 1200			

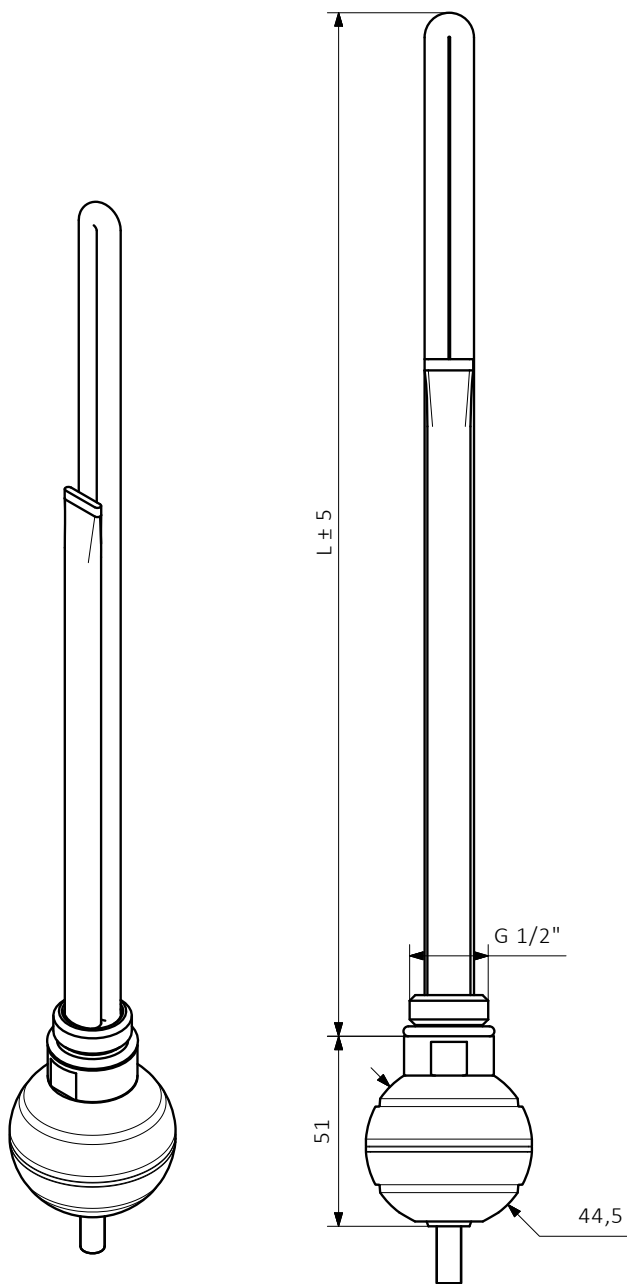

Gerades Kabel ohne Stecker

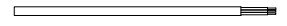

Gerades Kabel mit Stecker

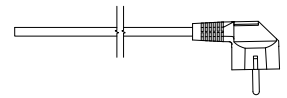

Gerades Kabel mit Stecker und Schalter

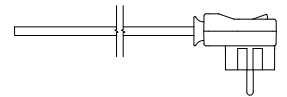

Spiralkabel mit Stecker

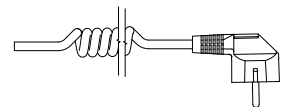

Spiralkabel mit Stecker und Schalter

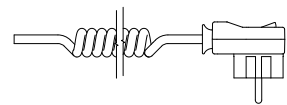

L [mm]	315	275	300	335	365	475	565	660
Leistung [W]	120	200	300	400	600	800	1000	1200

Funktionen und Eigenschaften:

Funktionalität

Die einfachste Heizpatrone ohne Temperaturregelung mit einem Überhitzungsschutz für ungewöhnliche Situationen. Das Gerät verfügt über einen Bimetall-Temperatursensor. Die Heizpatrone ist erhältlich bis zu einer Leistung von 1500 W.

Intelligente Gebäudesysteme

Das Gerät kann mit externen Timern oder intelligenten Gebäudesystemen zusammenarbeiten.

Sicherheit

Die Heizpatrone besitzt einen außerordentlich hohen Schutz gegen Feuchtigkeit und eine Thermo­sicherung gegen Betriebsstörungen.

Design

Edelstahlgehäuse. Die Heizpatrone besitzt keinen Schalter am Gehäuse, ist jedoch in einer Version mit Schalter am Stecker verfügbar.

Farben

Verfügbare Farben: Edelstahl.

Verfügbare Leistungen

120, 200, 300, 400, 600, 800, 1000, 1200, 1500 W

Technische Daten:

- Stromversorgung: 230 V AC
- Geräteschutzklasse: Klasse I
- Heizkörperanschluss: G 1/2"
- Gehäuseschutzstufe [IP]: IP67

Konfigurationstabelle:

Beispiel Bestellcode: **WE**^{Leistungscode}**SIM**^{Farbcode}**04**^{Modellcode}**T**^{Verpackungscode}**INX**^{Kabeltypcode}**W**

Codeelemente sind blau markiert.

Modell	Leistung [W]	Verpackung	Farbe	Kabeltyp
WE SIM SIM	01 120	F glatte Folie	INX Edelstahl	R Gerades Kabel mit Stecker und Schalter
	02 200			P Gerades Kabel ohne Stecker
	03 300			
	04 400			
	06 600			
	08 800			
	10 1000			
	12 1200			
	15 1500			

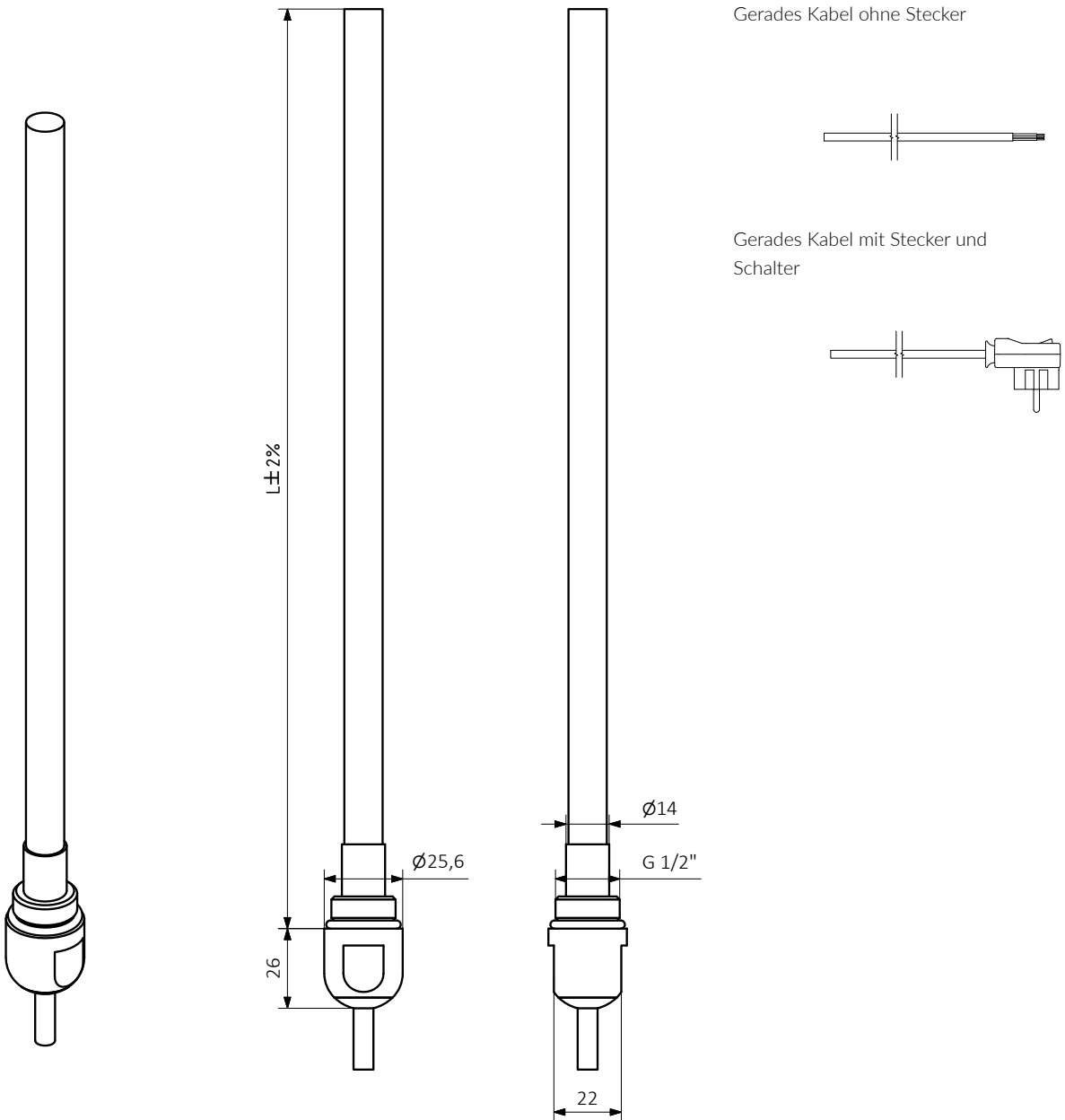

L [mm]	315	285	310	345	375	485	575	750	950
Leistung [W]	120	200	300	400	600	800	1000	1200	1500

Steuerungs-App Terma BlueLine



Funktionen und Eigenschaften:

- verwendet die moderne Technologie Bluetooth Low Energy
- ermöglicht ein intuitives Hinzufügen und Verwalten von Heizgeräten der Terma BLUE Line
- verfügbar für alle Mobilgeräte mit Android-System ab Version 4.0 oder IOS ab Version 6
- Verwaltung mehrerer Heizgeräte zur gleichen Zeit
- intuitive Vermeidung von Konflikten zwischen mehreren Benutzern
- ermöglicht die Erstellung eigener Arbeitspläne und ihre jederzeitige Aktivierung

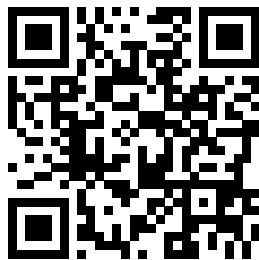

TTIR1



Funktionen und Eigenschaften:

Funktionalität

Die Fernsteuerung ermöglicht die Regulierung der Raumtemperatur im Bereich von 10°C bis 30°C in Schritten von 0,5°C. Das Gerät zeigt die aktuelle und die eingestellte Temperatur sowie die aktuelle Uhrzeit. Die Fernsteuerung bietet die Möglichkeit zur Einstellung von zwei Temperaturen: Ökonomisch und Komfort, steuerbar in 2 Modi: manuell und automatisch. Das Gerät bietet die Möglichkeit zur Kalibrierung des elektronischen Temperatursensors, falls die angezeigte Temperatur anders ist als die tatsächliche Raumtemperatur. Die Fernsteuerung kann an der Wand montiert werden oder funktioniert als tragbares Gerät.

Timer und Trockner

Der Wochentimer ermöglicht die Programmierung des Gerätes für Funktionen in bestimmten Modi während der ganzen Woche. Zur Auswahl steht außerdem eine Trockenfunk-

tion, welche den Betrieb der Heizpatronen zwischen 15 min. und 4 Stunden ermöglicht.

Fernsteuerung

Die Fernsteuerung arbeitet kabellos mit allen Terma Heizpatronen zusammen, die mit einem IR-Empfänger (Heizpatrone ONE, MOA-IR sowie KTX 4) ausgerüstet sind. Das Gerät kann zur Steuerung von mehreren Heizpatronen in einem Raum benutzt werden.

Intelligente Gebäudesysteme

Das Gerät ist batteriebetrieben mit einem niedrigen Stromverbrauch für eine lange Lebensdauer. Die Fernsteuerung benötigt keine Verbindung zu einer externen Stromversorgung.

Sicherheit

Die Fernsteuerung ist mit einem Frostschutz (ANTIFREEZE) ausgestattet. Dieser Modus schützt den Heizkörper vor Schäden durch Einfrieren.

Design

Eine gerade Linie in Verbindung mit einem weißen Körper verleihen dem Gerät ein modernes Aussehen und bieten den perfekten Rahmen für das elegante, bernsteinfarbene Display.

Farben

Das Gerät ist in Weiß lieferbar.

Stromversorgung

Kommunikationsmodul

Gehäuseschutzstufe

Farben

Artikelnummer

2 x LR03 (AAA)

IR

IP 30

WEISS

TGRTBI001

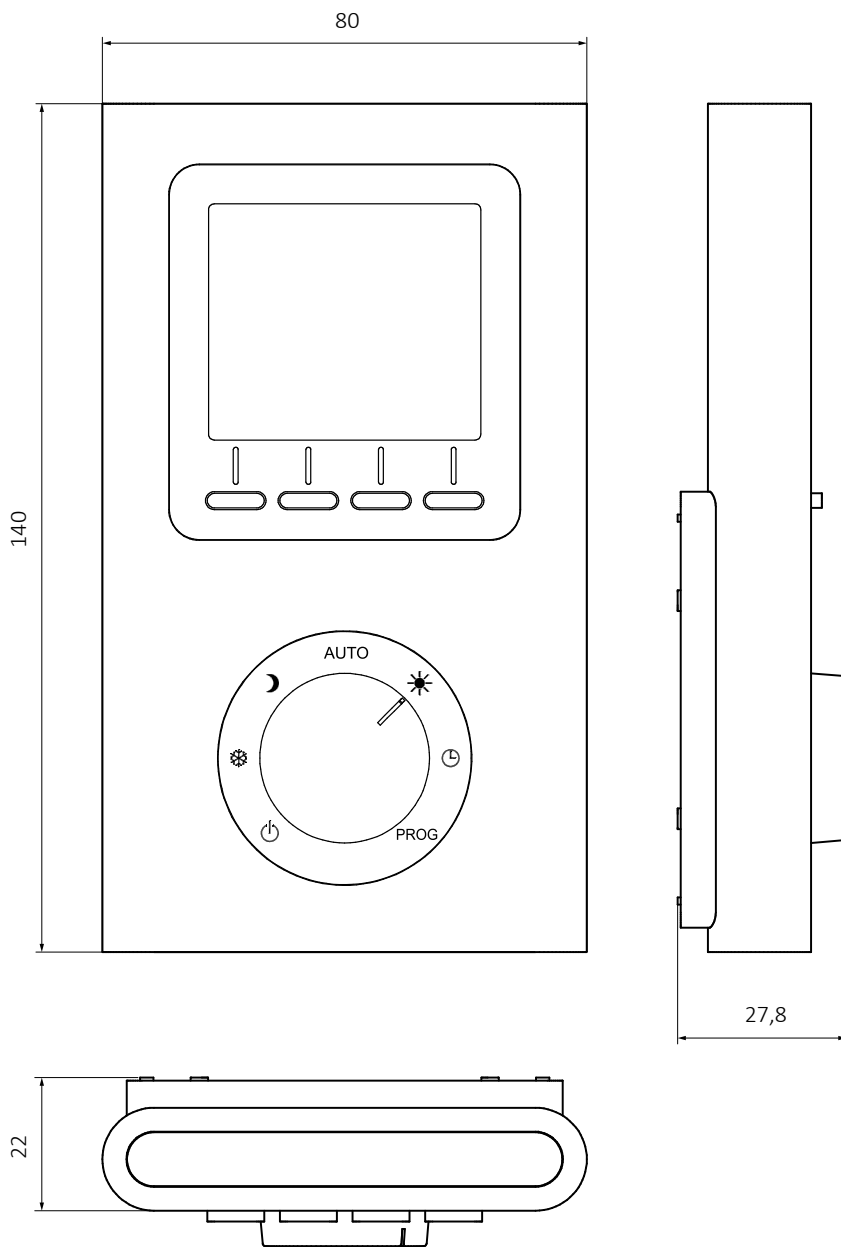

DTIR1



Funktionen und Eigenschaften:

Funktionalität

Die Fernsteuerung ermöglicht die präzise Regulierung der Raumtemperatur mit Schritten von 0,5°C. Anzeige der aktuellen und der eingestellten Temperatur. Das Gerät arbeitet in den Modi: manuell, automatisch, trocknen und Antifreeze. Es können zwei Temperatureinstellungen programmiert werden: Ökonomisch und Komfort. Das Gerät bietet die Möglichkeit zur Kalibrierung des elektronischen Temperatursensors, falls die angezeigte Temperatur anders ist als die tatsächliche Raumtemperatur. Die Fernsteuerung kann an der Wand montiert werden oder funktioniert als tragbares Gerät.

Timer und Trockner

Der Tagestimer erlaubt die Programmierung zum Ein- und Ausschalten des Gerätes mit Abständen von 15 min. Während des Betriebs

kann die Fernsteuerung im Temperaturmodus Ökonomisch oder Komfort benutzt werden. Der Trocken-Modus ermöglicht den Betrieb zwischen 15 min und 4 Stunden. Nach dieser Zeit geht das Gerät in den Automatikbetrieb zurück.

Fernsteuerung

Die Fernsteuerung arbeitet kabellos mit allen Terma Heizpatronen zusammen, die mit einem IR-Empfänger (Heizpatrone ONE, MOA-IR sowie KTX-4) ausgerüstet sind. Das Gerät kann zur Steuerung von mehreren Heizpatronen in einem Raum benutzt werden.

Intelligente Gebäudesysteme

Das Gerät ist batteriebetrieben mit einem niedrigen Stromverbrauch für eine lange Lebensdauer. Die Fernsteuerung benötigt keine Verbindung zu einer externen Stromversorgung.

Sicherheit

Die Fernsteuerung ist mit einem Frostschutz (ANTIFREEZE) ausgestattet. Dieser Modus schützt den Heizkörper vor Schäden durch Einfrieren.

Design

Einfaches, minimalistisches Gehäuse mit klarem, blauem Display. Leichtes und handliches Gerät.

Farben

Das Gerät ist erhältlich in zwei Farbvarianten: Weiß und Silber.

Stromversorgung	Kommunikationsmodul	Gehäuseschutzstufe	Farben	Artikelnummer
2 x LR03 (AAA)	IR	IP 30	Weiß	TGRDBI001
2 x LR03 (AAA)	IR	IP 30	Silber	TGRDSI001

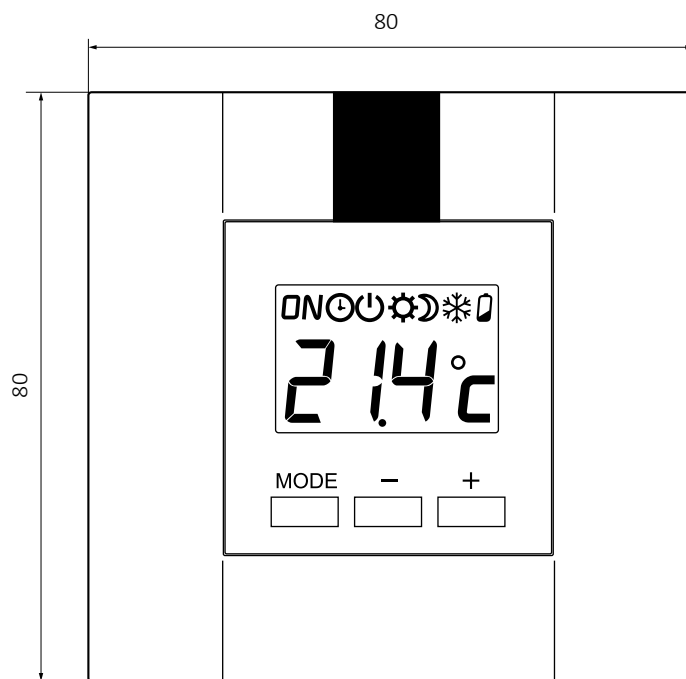

DTIR1



Funktionen und Eigenschaften:

Funktionalität

Die Fernsteuerung ermöglicht die präzise Regulierung der Raumtemperatur mit Schritten von 0,5°C. Anzeige der aktuellen und der eingestellten Temperatur. Das Gerät arbeitet in den Modi: manuell, automatisch, trocknen und Antifreeze. Es können zwei Temperatureinstellungen programmiert werden: Ökonomisch und Komfort. Das Gerät bietet die Möglichkeit zur Kalibrierung des elektronischen Temperatursensors, falls die angezeigte Temperatur anders ist als die tatsächliche Raumtemperatur. Die Fernsteuerung kann an der Wand montiert werden oder funktioniert als tragbares Gerät.

Timer und Trockner

Der Tagestimer erlaubt die Programmierung zum Ein- und Ausschalten des Gerätes mit Abständen von 15 min. Während des Betriebs

kann die Fernsteuerung im Temperaturmodus Ökonomisch oder Komfort benutzt werden. Der Trocken-Modus ermöglicht den Betrieb zwischen 15 min und 4 Stunden. Nach dieser Zeit geht das Gerät in den Automatikbetrieb zurück.

Fernsteuerung

Die Fernsteuerung arbeitet kabellos mit allen Terma Heizpatronen zusammen, die mit einem IR-Empfänger (Heizpatrone ONE, MOA-IR sowie KTX-4) ausgerüstet sind. Das Gerät kann zur Steuerung von mehreren Heizpatronen in einem Raum benutzt werden.

Intelligente Gebäudesysteme

Das Gerät ist batteriebetrieben mit einem niedrigen Stromverbrauch für eine lange Lebensdauer. Die Fernsteuerung benötigt keine Verbindung zu einer externen Stromversorgung.

Sicherheit

Die Fernsteuerung ist mit einem Frostschutz (ANTIFREEZE) ausgestattet. Dieser Modus schützt den Heizkörper vor Schäden durch Einfrieren.

Design

Einfaches, minimalistisches Gehäuse mit klarem, blauem Display. Leichtes und handliches Gerät.

Farben

Das Gerät ist erhältlich in zwei Farbvarianten: Weiß und Silber.

Stromversorgung	Kommunikationsmodul	Gehäuseschutzstufe	Farben	Artikelnummer
2 x LR03 (AAA)	IR	IP 30	Weiß	TGRDBI001
2 x LR03 (AAA)	IR	IP 30	Silber	TGRDSI001

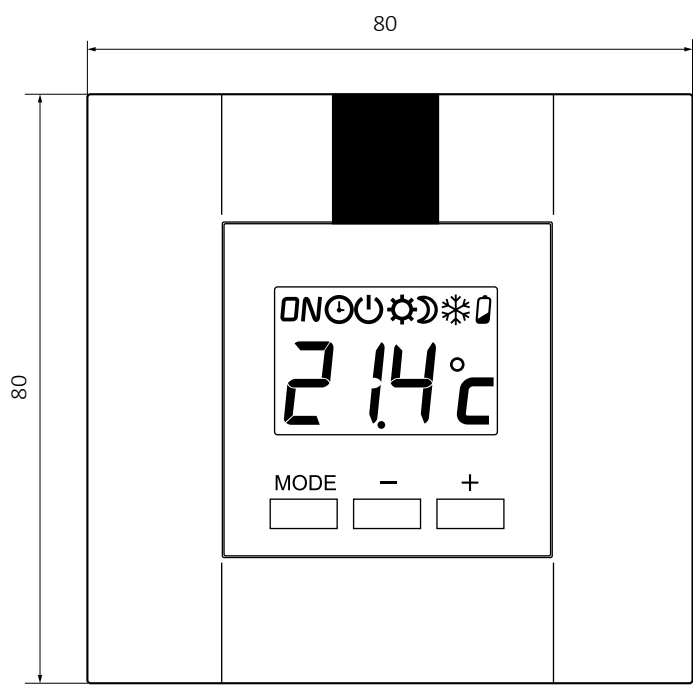

Richtige Auswahl der Heizpatrone

Das erste und wichtigste Kriterium für die richtige Auswahl der Heizpatrone zu einem Heizkörper ist seine Leistung. Die Leistung der Heizpatrone passen wir der Effizienz des Heizkörpers für die Parameter 75/65/20°C an. Diese basieren auf den folgenden Kriterien:

- Für die meisten Heizpatronen mit einer Temperatureinstellung von ca. 60°C bis 65°C (z.B. MEG, MOA, REG, KTX, ONE) sollte die Leistung der Heizpatrone in der Nähe der Leistung des Heizkörpers sein.
- Wenn die Heizpatrone mit einem selbstregulierenden Element PTC ausgestattet ist (SKT, SOA) darf die Heizleistung der Heizpatrone die Leistung des Heizgerätes nicht übersteigen.

Die Berücksichtigung der oben genannten Kriterien bei der Auswahl der Heizpatrone sorgt für einen sicheren, voll funktionsfähigen und effektiven Betrieb der Heizung. Zusätzlich sollten bei der Auswahl der Heizpatrone auch Eigenschaften berücksichtigt werden, wie: Benutzerfreundlichkeit, Einstellungsmöglichkeiten und die Bestimmung (Trocknen oder Heizen von Räumen). Besonders zu empfehlen sind Heizpatronen, welche Funktionen zur Vereinfachung der Bedienung bieten (z.B. eine automatische Abschaltung nach einer voreingestellten Zeit für eine wirtschaftliche Trocknung von Handtüchern oder Kleidung). Sie sollten auch über die Notwendigkeit einer zusätzlichen Regelung der Raumtemperatur nachdenken – hierzu können Sie eine Heizpatrone mit einer separaten, drahtlosen Fernsteuerung wählen.

Möglichkeiten zur Verbindung von Heizpatronen mit einem Wasser-Heizkörper

Eine breite Auswahl von Verbindungsöffnungen im Heizkörper ermöglicht die Wahl der optimalen Version zur Zusammenarbeit von Heizkörper und elektrischer Heizpatrone. Die Kombination bietet viele Vorteile. Hauptsächlich:

- Verwendung eines Standard-Leiterheizkörpers (wasserbetrieben) als Trockner für Kleidung oder Handtücher auch außerhalb der Heizperiode (z.B. im Sommer),

- Möglichkeit zur Aufheizung von Räumen (z.B. Badezimmer) in den Übergangszeiten Herbst – Frühling ohne die komplette Heizungsanlage anschalten zu müssen.

Vor dem Einbau der Heizpatrone ist es lohnenswert sich mit den verfügbaren Informationsmaterialien vertraut zu machen sowie einen Blick auf unsere Homepage www.termahat.pl zu werfen. Empfohlene Möglichkeiten zur Installation einer Heizpatrone in einem Wasserheizkörper werden in den folgenden Zeichnungen dargestellt:

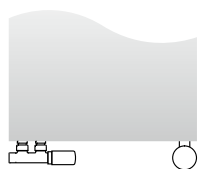

[Zeichnung 1 – direkter Anschluss der Heizpatrone an den Heizkörper und Verwendung eines Thermostatventils 50 mm] Anschluss Z1, Z8, Y8, Y1

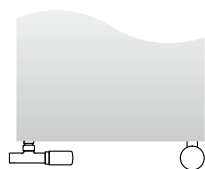

[Zeichnung 2 – direkter Anschluss der Heizpatrone an den Heizkörper und Verwendung eines Lansen-Thermostatventils] Anschluss SX, S1, S8

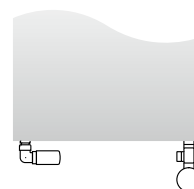

[Zeichnung 3 – Anschluss der Heizpatrone über ein integriertes Absperrventil mit T-Stück] Anschluss SX

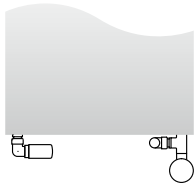

[Zeichnung 4 – Anschluss der Heizpatrone über ein T-Stück und ein Absperrventil] Anschluss SX

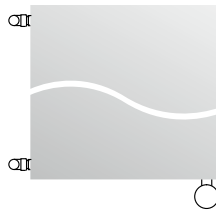

[Zeichnung 5 – direkter Anschluss der Heizpatrone an den Heizkörper und seitlicher Anschluss an die Zentralheizung] Anschluss L8, P1, 58, 51

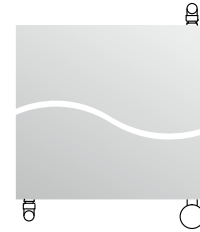

[Zeichnung 6 – direkter Anschluss der Heizpatrone an den Heizkörper und Überkreuzanschluss an die Zentralheizung] Anschluss GD, UN, UC

Während der Benutzung einer Heizpatrone in einem Wasserheizkörper muss immer eines der Ventile geöffnet sein. Dadurch wird ein Druckaufbau beim Betrieb der Heizpatrone verhindert, der zu einer Beschädigung der Heizpatrone oder des Heizkörpers führen könnte.

Die Verteilung und die Höhe der Temperatur an der Oberfläche eines Heizkörpers hängt von vielen Faktoren ab. Wesentlich ist die Geometrie des Heizkörpers. Eine Heizpatrone sollte immer an der unteren Seite der Heizkörpers eingebaut werden.

Die TERMA Heizpatronen erfüllen alle europäischen Normen für die Sicherheit und den Schutz des Anwenders vor den Gefahren von Verbrennungen. Aus diesem Grund ist es wichtig, dass die Wassertemperatur in der Zentralheizung, bei Verwendung einer Heizpatrone, nicht höher als 82°C ist, da dies zu Schäden an der Thermosicherung in der Heizpatrone führen kann.

Die Heizpatrone ist ein Element, das über den Heizkörper hinausragt. Aus diesem Grund müssen Sie einen Montageplatz wählen, bei dem die Gefahr einer mechanischen Beschädigung des Gehäuses der Heizpatrone minimiert wird (nicht freistehend und keine anderen Gegenstände anhängen).

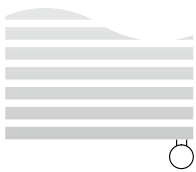

[Zeichnung 7 – Anschluss der Heizpatrone von unten, vertikal, bei einem Heizkörper mit horizontalen Querrohren] Anschluss E1, E8, EX

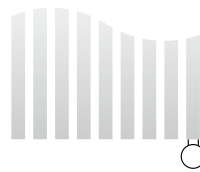

[Zeichnung 8 – Anschluss der Heizpatrone von unten, vertikal, bei einem Heizkörper mit vertikalen Querrohren]



[Zeichnung 9 – Horizontaler Anschluss der Heizpatrone, direkt in den Heizkörper mit vertikalen Profilen]

Aufbau des Konfigurationscodes

Aufbau des Konfigurationscodes für Wasser- und Wasser-Elektrische-Heizkörper

Die Tabellen auf den technischen Produkt-Datenblättern stellen Artikelnummern dar, welche die grundlegenden Informationen über die Produkte enthalten. Um die Eigenschaften eines Produktes zu präzisieren muss der Produktcode um einen Konfigurationscode ergänzt werden. Der Konfigurationscode muss nach dem Produktcode geschrieben werden, wie in nachfolgendem Beispiel:

Bestellcode

WGALE054030

K916SX

ARTIKELNUMMER

(dargestellt in der Tabelle auf der Seite des Produktes)

KONFIGURATIONSCODE

(von Hand zu ergänzen)

Konfiguration

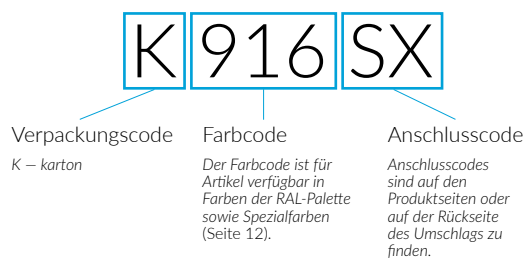

Epoxid-Grundierung

E – Der Code für die Epoxid-Grundierung steht an der Stelle für Nichtstandard-Codes.

WLALE054030 K916SX **E** — Nichtstandard-Codes

Aufbau des Konfigurationscodes für Heizkörper mit eingebauter Heizpatrone ONE.

Die Tabellen auf den technischen Produkt-Datenblättern stellen Artikelnummern dar, welche die grundlegenden Informationen über die Produkte enthalten. Um die Eigenschaften eines Produktes zu präzisieren muss der Produktcode um einen Konfigurationscode ergänzt werden. Der Konfigurationscode muss nach dem Produktcode geschrieben werden, wie in nachfolgendem Beispiel:

Bestellcode

WWBNN076050

ARTIKELNUMMER
(dargestellt in der Tabelle auf der Seite des Produktes)

K916E1W

KONFIGURATIONSCODE
(von Hand zu ergänzen)

Konfiguration

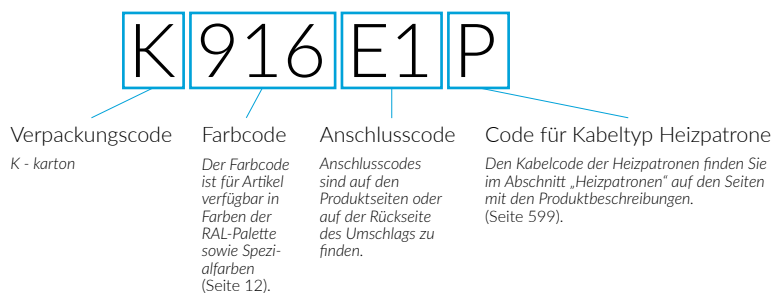

Epoxid-Grundierung

E - Der Code für die Epoxid-Grundierung steht an der Stelle für Nichtstandard-Codes.

WLALE054030 K916SX **E** — Nichtstandard-Codes

Aufbau des Konfigurationscodes für ElektroHeizkörper mit Heizmedium.

Die Tabellen auf den technischen Produkt-Datenblättern stellen Artikelnummern dar, welche die grundlegenden Informationen über die Produkte enthalten. Um die Eigenschaften eines Produktes zu präzisieren muss der Produktcode um einen Konfigurationscode ergänzt werden. Der Konfigurationscode muss nach dem Produktcode geschrieben werden, wie in nachfolgendem Beispiel:

Bestellcode

WLALE054030

K916E1DRYM

ARTIKELNUMMER

(dargestellt in der Tabelle auf der Seite des Produktes)

KONFIGURATIONSCODE

(von Hand zu ergänzen)

Konfiguration

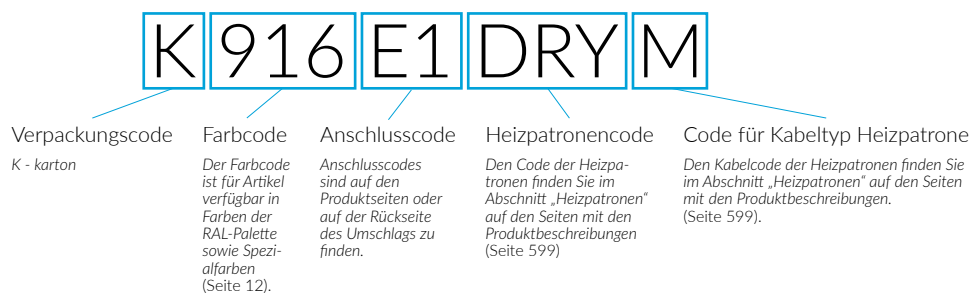

Epoxid-Grundierung

E – Der Code für die Epoxid-Grundierung steht an der Stelle für Nichtstandard-Codes.

WLALE054030 K916SX **E** – Nichtstandard-Codes

Aufbau des Konfigurationscodes für ElektroHeizkörper mit Heizdraht.

Die Tabellen auf den technischen Produkt-Datenblättern stellen Artikelnummern dar, welche die grundlegenden Informationen über die Produkte enthalten. Um die Eigenschaften eines Produktes zu präzisieren muss der Produktcode um einen Konfigurationscode ergänzt werden. Der Konfigurationscode muss nach dem Produktcode geschrieben werden, wie in nachfolgendem Beispiel:

Bestellcode

WSPER136050

K916EXW

ARTIKELNUMMER

(dargestellt in der Tabelle auf der Seite des Produktes)

KONFIGURATIONSCODE

(von Hand zu ergänzen)

Konfiguration

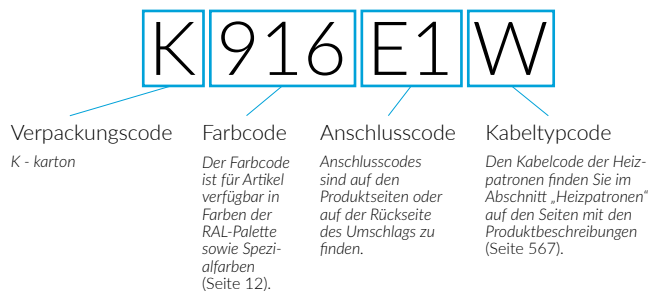

Epoxid-Grundierung

E - Der Code für die Epoxid-Grundierung steht an der Stelle für Nichtstandard-Codes.

WLAL054030 K916SX **E** — Nichtstandard-Codes

Aufbau des Konfigurationscodes für individuelles Zubehör.

Die Tabellen auf den technischen Produkt-Datenblättern stellen Artikelnummern dar, welche die grundlegenden Informationen über die Produkte enthalten. Um die Eigenschaften eines Produktes zu präzisieren muss der Produktcode um einen Konfigurationscode ergänzt werden. Der Konfigurationscode muss nach dem Produktcode geschrieben werden, wie in nachfolgendem Beispiel:

Bestellcode

WRRCAS044

ARTIKELNUMMER
(dargestellt in der Tabelle auf der Seite
des Produktes)

K916

KONFIGURATIONSCODE
(von Hand zu ergänzen)

Konfiguration

K 916

Verpackungscod
K - karton

Farbcode
Der Farbcode ist für Artikel verfügbar in Farben der RAL-Palette sowie Spezialfarben (Seite 12).

Legende



Der Heizkörper ist auch als Wasserversion erhältlich.



Der Heizkörper ermöglicht den Anschluss an die Zentralheizungsanlage und den Anschluss einer elektrischen Heizpatrone.



Der Heizkörper ist in einer Elektroversion, befüllt mit einem Heizmedium und mit einer Heizpatrone ausgerüstet, erhältlich. Das Produkt ist werksseitig vorgetestet und einsatzbereit.



Der Heizkörper ist auch in Chrom erhältlich.

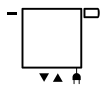

Standardvarianten der Anschlussstypen. Das Symbol zeigt wie Zu- und Rücklauf angeschlossen werden müssen sowie den Anschluss für den Thermostatkopf und die Heizpatrone, falls die Möglichkeit für die Montage besteht.



Empfohlene Leistung des Heizstabs für Elektro- und Wasser-/Elektroheizkörper.



Gewicht.



Kapazität.



Chrom.



Nickel.



Satiniert.



Weiß.



Brush Copper.

Anschlussstabelle

	Wasser-Heizkörper																									Elektro-Heizkörper																													
	SX	S1	S8	ZX	Z1	Z8	ZS	YL	YP	Y1	Y8	Y2	Y7	VL	VP	V3	V6	V2	V7	LX	L6	L8	L7	5L	58	PX	P3	P1	P2	5P	51	O1	O8	LP	GD	AX	YX	E1	E8	E2	E7	EX													
AERO H	o							o	o												o	o					o	o												o															
AERO HG	o							o	o													o	o					o	o														o												
AERO V	o			o																	o						o																o												
ALEX	o			o	o	o															o		o		o	o	o	o	o	o	o	o	o	o										o	o										
ALEX ONE		o	o																			o		o				o																o	o										
ANGUS DW	o			o				o	o	o	o																																			o	o								
ANGUS H (A 360+520)	o			o				o	o			o	o								o	o					o	o																	o		o	o							
ANGUS H (A 600+680)	o			o				o	o			o	o								o	o		o	o	o	o	o	o	o	o	o	o	o	o	o									o		o	o							
ANGUS V	o			o				o	o	o	o										o	o	o	o	o	o	o	o	o	o	o	o	o	o	o	o	o									o	o								
BONE	o			o	o	o															o	o	o	o	o	o	o	o	o	o	o	o	o	o	o	o	o	o	o	o	o	o	o	o	o	o	o	o	o	o					
BONE DW				o	o																																											o							
BONE ONE		o	o																			o		o				o																			o	o							
CANE				o	o	o		o	o	o	o																																												
CANE E																																																	o	o					
CASE SLIM	o			o	o	o																																												o	o				
CITY (A 510)	o			o	o	o															o	o	o				o	o	o																					o	o				
CITY (A 780+1860)	o			o	o	o															o	o	o	o	o	o	o	o	o	o	o	o	o	o	o	o	o	o	o	o	o	o	o	o	o	o	o	o	o	o	o	o			
CITY ONE		o	o																			o		o				o																								o	o		
CYKLON H																																																							
CYKLON V								o	o																																														
DELFIN (A 1800+2000)	o			o				o	o													o						o																											
DELFIN (A 440+640)	o							o	o		o	o	o	o				o	o			o						o																							o	o			
DEXTER	o			o	o	o																																																	
DEXTER ONE		o	o																																																				
DEXTER PRO				o	o	o																																																	
DEXTER PRO ONE				o	o																																																		
DIAMOND	o			o	o	o															o	o	o		o	o	o	o	o	o	o	o	o	o	o	o	o	o	o	o	o	o	o	o	o	o	o	o	o	o	o	o			
DOMI	o			o	o	o																																																	
EASY	o																				o	o		o	o	o	o	o	o	o	o	o	o	o	o	o	o	o	o	o	o	o	o	o	o	o	o	o	o	o	o	o	o		
EASY DW																																																							
EASY ONE		o	o																																																				
FIONA	o			o	o	o															o	o		o	o	o	o	o	o	o	o	o	o	o	o	o	o	o	o	o	o	o	o	o	o	o	o	o	o	o	o	o	o		
FIONA ONE		o	o																			o		o				o																											
HEX (A 402+502)								o	o																																														
HEX (A 821+1700)				o																																																			
INCORNER (A 465)	o																				o	o			o	o	o	o	o	o	o	o	o	o	o	o	o	o	o	o	o	o	o	o	o	o	o	o	o	o	o	o			
INCORNER (A 735+1545)	o																				o	o		o	o	o	o	o	o	o	o	o	o	o	o	o	o	o	o	o	o	o	o	o	o	o	o	o	o	o	o	o	o		
INTRA	o			o				o	o												o						o																												
INTRA M	o			o				o	o												o						o																												
IRON D				o																																																			
KIOTO	o																																																						
KIOTO ONE		o	o																																																				
LENA	o			o	o	o																																																	
LIMA (A 300)	o			o																	o	o				o	o	o	o	o	o	o	o	o	o	o	o	o	o	o	o	o	o	o	o	o	o	o	o	o	o	o	o		
LIMA (A 500)	o			o	o	o															o	o				o	o	o	o	o	o	o	o	o	o	o	o	o	o	o	o	o	o	o	o	o	o	o	o	o	o	o	o		
LIMA (A 820+1700)	o			o	o	o															o	o		o	o	o	o	o	o	o	o	o	o	o	o	o	o	o	o	o	o	o	o	o	o	o	o	o	o	o	o	o	o		
LIMA ONE		o	o																																																				
LUKKA (V151)	o			o	o	o															o	o	o	o	o	o	o	o	o	o	o	o	o	o	o	o	o	o	o	o	o	o	o	o	o	o	o	o	o	o	o	o	o		
MANTIS	o			o	o	o																																																	

